

LINEAR INTEGRATED CIRCUITS

MOTOR SPEED REGULATORS

The TCA 900 and TCA 910 are monolithic integrated circuits in Jedec TO-126 plastic package. They are designed for use as speed regulators for DC motors of record players, cassette recorders and players. The TCA 900 is particularly suitable for battery operated portable equipments, and the TCA 910 for car-battery and mains operations.

ABSOLUTE MAXIMUM RATINGS

		TCA 900	TCA 910
V_s	Supply voltage	14V	20V
P_{tot}	Total power dissipation at $T_{amb} = 70^\circ\text{C}$ at $T_{case} = 100^\circ\text{C}$		0.8 W 5 W
T_{stg}	Storage temperature	-55 to 150°C	
T_j	Junction temperature	150 $^\circ\text{C}$	

ORDERING NUMBERS: TCA 900
TCA 910

MECHANICAL DATA

Dimensions in mm

Pin 3 connected to metal part of mounting surface

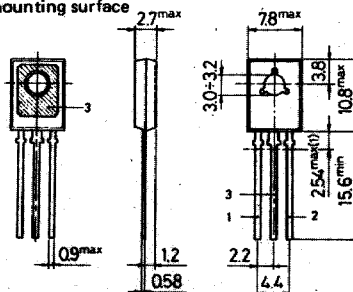

C-0054/2



CONNECTION AND SCHEMATIC DIAGRAMS

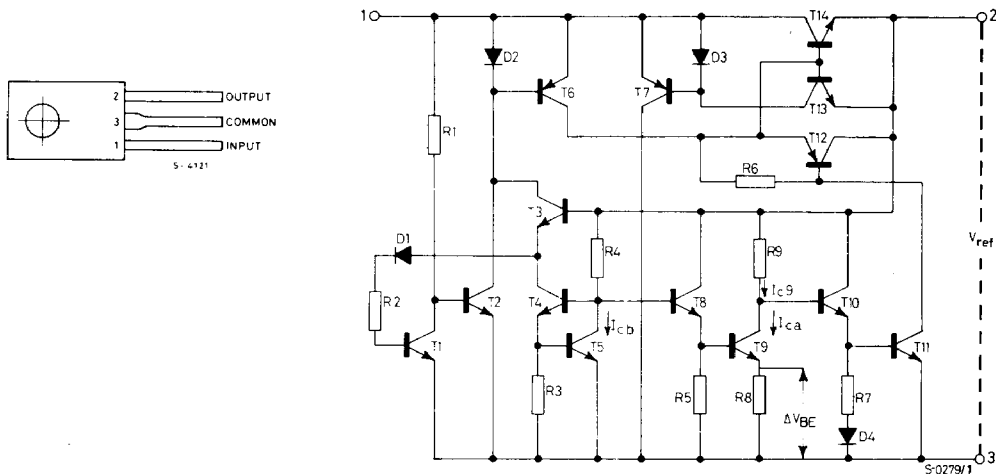

THERMAL DATA

$R_{th\ j-case}$	Thermal resistance junction-case	Typ.	10	°C/W
$R_{th\ j-amb}$	Thermal resistance junction-ambient	Typ.	100	°C/W

ELECTRICAL CHARACTERISTICS (Refer to the test circuit, $T_{amb} = 25^\circ\text{C}$ unless otherwise specified)

Parameter	Test conditions	Min.	Typ.	Max.	Unit
V_{ref}	Reference voltage (between pins 2 and 3) $V_s = 5.5\text{V}$ $I_m = 70\text{mA}$ $R_T = 0$		2.6		V
I_{d3}	Quiescent current (at pin 3) $V_s = 5.5\text{V}$ $I_m = 0$ $R_T = 0$		2.6		mA
V_m	Output voltage (for TCA 900 only) $V_s = 5.5\text{V}$ $I_m = 70\text{mA}$ $R_T = 91\Omega$		3.6	3.9	V
V_m	Output voltage (for TCA 910 only) $V_s = 9\text{V}$ $I_m = 70\text{mA}$ $R_T = 270\Omega$		5.6	6.3	V



ELECTRICAL CHARACTERISTICS (continued)

Parameter	Test conditions	Min.	Typ.	Max.	Unit
V_{1-2} Dropout voltage	$\Delta V_m/V_m = -1\%$ $I_m = 70 \text{ mA}$ $R_T = 91\Omega$		1.2		V
I_2 Limiting output current (at pin 2)	$V_s = 5.5\text{V}$ $V_{2-3} = 0$		400		mA
$k = \Delta I_2/\Delta I_3$	$V_s = 5.5\text{V}$ $I_2 = 70 \text{ mA}$ $\Delta I_2 = \pm 10 \text{ mA}$ $R_T = 0$		8.5		—
$\frac{\Delta V_m}{V_m} / \Delta V_s$ Line regulation (for TCA 900 only)	$V_s = 5.5\text{V to } 12\text{V}$ $I_m = 70 \text{ mA}$ $R_T = 91\Omega$		0.1		%/V
$\frac{\Delta V_m}{V_m} / \Delta V_s$ Line regulation (for TCA 910 only)	$V_s = 10\text{V to } 16\text{V}$ $I_m = 70 \text{ mA}$ $R_T = 270\Omega$		0.1		%/V
$\frac{\Delta V_m}{V_m} / \Delta I_m$ Load regulation	$V_s = 5.5\text{V}$ $I_m = 40 \text{ to } 100 \text{ mA}$ $R_T = 0$		0.005		%/mA
$\frac{\Delta V_{ref}}{V_{ref}} / \Delta T_{amb}$ Temperature coefficient	$V_{1-3} = 5.5\text{V}$ $I_2 = 70 \text{ mA}$ $T_{amb} = -20 \text{ to } 70^\circ\text{C}$		0.01		%/°C

Fig. 1 - Test circuit.

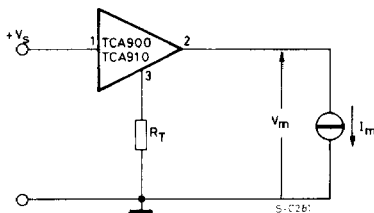

Fig. 2 - Typical application circuit.

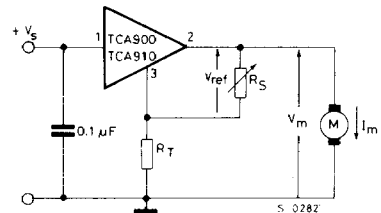



Fig. 3 - Normalized k vs. I_2 .

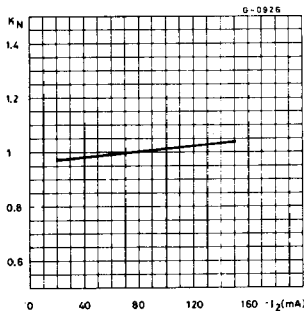

Fig. 4 - Dropout voltage vs. output current

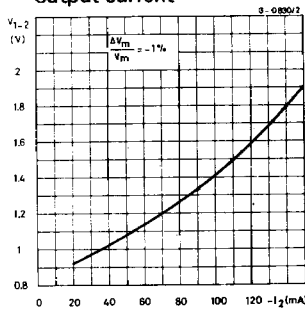
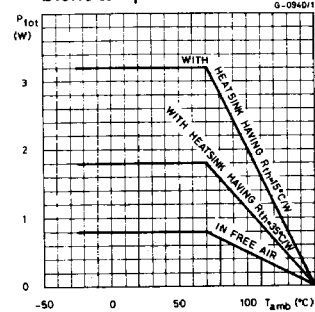

Fig. 5 - Maximum allowable power dissipation vs. ambient temperature



APPLICATION INFORMATION

The regulator supplies the motor in such a way as to keep its speed constant, independent of supply voltage, applied torque and ambient temperature variations.

The basic equation for the motor is:

$$V_m = E_0 + R_m I_m = a_1 n + a_2 c$$

Where: V_m = supply voltage applied to the motor
 E_0 = back electromotive force
 n = motor speed (r.p.m.)
 R_m = internal resistance (of the motor)
 I_m = current absorbed (by the motor)
 a_1 and a_2 = constants
 c = drive torque

A voltage supply with the following characteristics

$E = E_0$ E = electromotive force

$R_o = -R_m$ R_o = output resistance

gives performance required.

This means that a variation in current absorbed by the motor, due to a variation in torque applied, causes a proportional variation in regulator output voltage. In fig. 6 is shown the minimum allowable E_0 vs. R_T . The TCA 900 and TCA 910 give a reference constant voltage V_{ref} (between pins 2 and 3) independent of variations of V_s , I_2 and ambient temperature.

They also give: $I_3 = I_{d3} + I_2/k$

Where: I_3 = total current at pin 3
 I_{d3} = quiescent current at pin 3 ($I_2 = 0$)
 I_2 = current at pin 2
 k = constant

The output voltage V_m , applied to the motor has the following value:

$$V_m = \underbrace{V_{ref} + R_T \left[\frac{V_{ref}}{R_s} \left(1 + \frac{1}{k} \right) + I_{d3} \right]}_{\text{Term 1}} + \underbrace{\frac{I_m}{k} R_T}_{\text{Term 2}}$$

Term 1 equals E_0 and fixes the motor speed by means of the variable resistor R_s ;

Term 2 $\frac{I_m}{k} R_T$ equals the term $R_m I_m$ and, therefore, compensates variations of torque applied. Complete compensation is achieved when:

$$R_T = k R_m$$

$I_f R_{T \max} > k R_{m \min}$ instability may occur.

Fig. 6 - Minimum E_0 allowable vs. R_T

