

# CD4060B Types

## CMOS 14-Stage Ripple-Carry Binary Counter/Divider and Oscillator

### High-Voltage Types (20-Volt Rating)

■ CD4060B consists of an oscillator section and 14 ripple-carry binary counter stages. The oscillator configuration allows design of either RC or crystal oscillator circuits. A RESET input is provided which resets the counter to the all-O's state and disables the oscillator. A high level on the RESET line accomplishes the reset function. All counter stages are master-slave flip-flops. The state of the counter is advanced one step in binary order on the negative transition of  $\phi_1$  (and  $\phi_0$ ). All inputs and outputs are fully buffered. Schmitt trigger action on the input-pulse line permits unlimited input-pulse rise and fall times.

The CD4060B-series types are supplied in 16-lead hermetic dual-in-line ceramic packages (F3A suffix), 16-lead dual-in-line plastic packages (E suffix), 16-lead small-outline packages (M, M96, MT, and NSR suffixes), and 16-lead thin shrink small-outline packages (PW and PWR suffixes).

### Features:

- 12 MHz clock rate at 15 V
- Common reset
- Fully static operation
- Buffered inputs and outputs
- Schmitt trigger input-pulse line
- 100% tested for quiescent current at 20 V
- Standardized, symmetrical output characteristics
- 5-V, 10-V, and 15-V parametric ratings
- Meets all requirements of JEDEC Tentative Standard No. 13B, "Standard Specifications for description of "B" Series CMOS Devices"

### Oscillator Features:

- All active components on chip
- RC or crystal oscillator configuration
- RC oscillator frequency of 690 kHz min. at 15 V

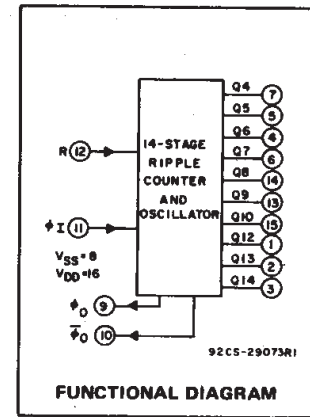

### Applications

- Control counters
- Timers
- Frequency dividers
- Time-delay circuits

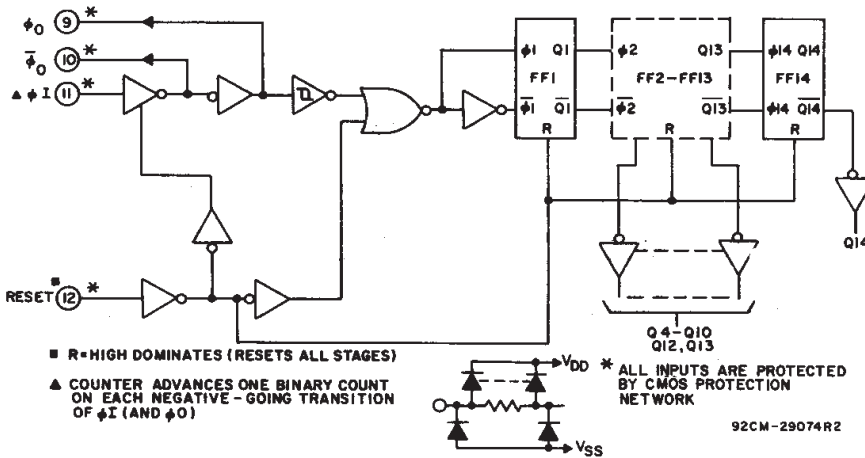

Fig. 1 – Logic diagram.



Fig. 2 – Detail of typical flip-flop stage.

### MAXIMUM RATINGS, Absolute-Maximum Values:

DC SUPPLY-VOLTAGE RANGE, (V <sub>DD</sub> )	
Voltages referenced to V <sub>SS</sub> Terminal	–0.5V to +20V
INPUT VOLTAGE RANGE, ALL INPUTS	–0.5V to V <sub>DD</sub> + 0.5V
DC INPUT CURRENT, ANY ONE INPUT	±10mA
POWER DISSIPATION PER PACKAGE (P <sub>D</sub> ):	
For T <sub>A</sub> = –55°C to +100°C	500mW
For T <sub>A</sub> = +100°C to +125°C	Derate Linearly at 12mW/°C to 200mW
DEVICE DISSIPATION PER OUTPUT TRANSISTOR	
FOR T <sub>A</sub> = FULL PACKAGE-TEMPERATURE RANGE (All Package Types)	100mW
OPERATING-TEMPERATURE RANGE (T <sub>A</sub> )	–55°C to +125°C
STORAGE TEMPERATURE RANGE (T <sub>stg</sub> )	–65°C to +150°C
LEAD TEMPERATURE (DURING SOLDERING):	
At distance 1/16 ± 1/32 inch (1.59 ± 0.79mm) from case for 10s max	+265°C

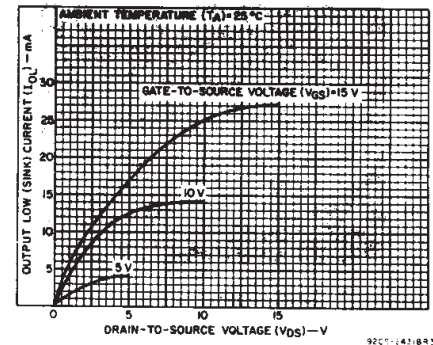

Fig. 3 – Typical n-channel output low (sink) current characteristics.

# CD4060B Types

## STATIC ELECTRICAL CHARACTERISTICS

CHARACTERISTIC	CONDITIONS			LIMITS AT INDICATED TEMPERATURES (°C)							UNITS
	V <sub>O</sub> (V)	V <sub>IN</sub> (V)	V <sub>DD</sub> (V)	-55	-40	+85	+125	+25			
								Min.	Typ.	Max.	
Quiescent Device Current, I <sub>DD</sub> Max.	—	0,5	5	5	5	150	150	—	0,04	5	μA
	—	0,10	10	10	10	300	300	—	0,04	10	
	—	0,15	15	20	20	600	600	—	0,04	20	
	—	0,20	20	100	100	3000	3000	—	0,08	100	
Output Low (Sink) Current*, I <sub>OL</sub> Min.	0,4	0,5	5	0,64	0,61	0,42	0,36	0,51	1	—	mA
	0,5	0,10	10	1,6	1,5	1,1	0,9	1,3	2,6	—	
	1,5	0,15	15	4,2	4	2,8	2,4	3,4	6,8	—	
Output High (Source) Current*, I <sub>OH</sub> Min.	4,6	0,5	5	-0,64	-0,61	-0,42	-0,36	-0,51	-1	—	mA
	2,5	0,5	5	-2	-1,8	-1,3	-1,15	-1,6	-3,2	—	
	9,5	0,10	10	-1,6	-1,5	-1,1	-0,9	-1,3	-2,6	—	
	13,5	0,15	15	-4,2	-4	-2,8	-2,4	-3,4	-6,8	—	
Output Voltage: Low-Level, V <sub>OL</sub> Max.	—	0,5	5	0,05				—	0	0,05	V
	—	0,10	10	0,05				—	0	0,05	
	—	0,15	15	0,05				—	0	0,05	
Output Voltage: High-Level, V <sub>OH</sub> Min.	—	0,5	5	4,95				4,95	5	—	V
	—	0,10	10	9,95				9,95	10	—	
	—	0,15	15	14,95				14,95	15	—	
Input Low Voltage V <sub>IL</sub> Max.	0,5, 4,5	—	5	1,5				—	—	1,5	V
	1,9	—	10	3				—	—	3	
	1,5, 13,5	—	15	4				—	—	4	
Input High Voltage, V <sub>IH</sub> Min.	0,5, 4,5	—	5	3,5				3,5	—	—	V
	1,9	—	10	7				7	—	—	
	1,5, 13,5	—	15	11				11	—	—	
Input Current I <sub>IN</sub> Max.	—	0,18	18	±0,1	±0,1	±1	±1	—	±10 <sup>-5</sup>	±0,1	μA

\* Data not applicable to terminal 9 or 10.

## RECOMMENDED OPERATING CONDITIONS

For maximum reliability, nominal operating conditions should be selected so that operation is always within the following ranges

CHARACTERISTIC	V <sub>DD</sub>	LIMITS		UNITS
		MIN.	MAX.	
Supply-Voltage Range (For T <sub>A</sub> = Full Package Temperature Range)	—	3	18	V
Input-Pulse Width, t <sub>W</sub> (f = 100 kHz)	5	100	—	ns
	10	40	—	
	15	30	—	
Input-Pulse Rise Time and Fall Time, t <sub>rφ</sub> , t <sub>fφ</sub>	5	Unlimited		
	10	Unlimited		
	15	Unlimited		
Input-Pulse Frequency, f <sub>φI</sub> (External pulse source)	5	—	3,5	MHz
	10	—	8	
	15	—	12	
Reset Pulse Width, t <sub>W</sub>	5	120	—	ns
	10	60	—	
	15	40	—	

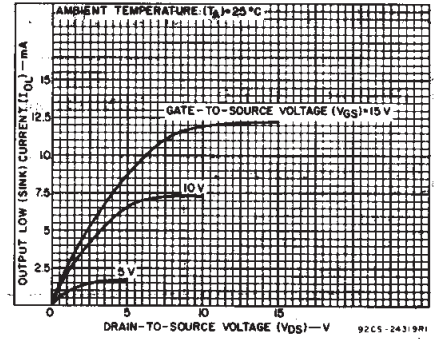

Fig. 4 - Minimum n-channel output low (sink) current characteristics.

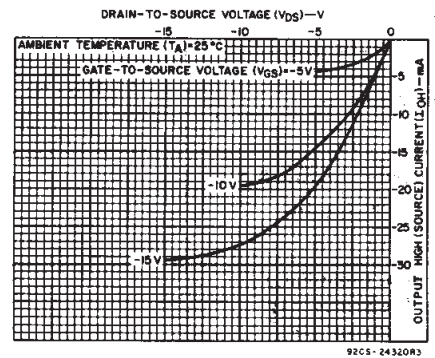

Fig. 5 - Typical p-channel output high (source) current characteristics.

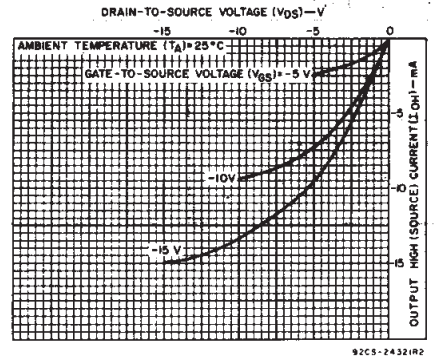

Fig. 6 - Minimum p-channel output high (source) current characteristics.

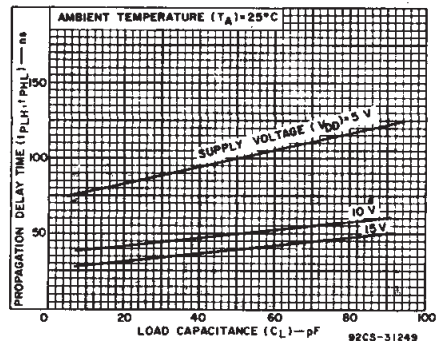

Fig. 7 - Typical propagation delay time (Q<sub>n</sub> to Q<sub>n+1</sub>) as a function of load capacitance.

3  
COMMERCIAL CMOS  
HIGH VOLTAGE ICs

# CD4060B Types

DYNAMIC ELECTRICAL CHARACTERISTICS at  $T_A = 25^\circ\text{C}$ , Input  $t_r, t_f = 20\text{ ns}$ ,  $C_L = 50\text{ pF}$ ,  $R_L = 200\text{ k}\Omega$

CHARACTERISTIC	TEST CONDITIONS	LIMITS			UNITS	
		V <sub>DD</sub> (V)	MIN.	TYP.		MAX.
<b>Input-Pulse Operation</b>						
Propagation Delay Time, $\phi_I$ to Q4 Out; $t_{PHL}, t_{PLH}$		5	—	370	740	ns
		10	—	150	300	
		15	—	100	200	
Propagation Delay Time, $Q_n$ to $Q_{n+1}$ ; $t_{PHL}, t_{PLH}$		5	—	100	200	
		10	—	50	100	
		15	—	40	80	
Transition Time, $t_{THL}, t_{TLH}$		5	—	100	200	
		10	—	50	100	
		15	—	40	80	
Min. Input-Pulse Width, $t_W$	$f = 100\text{ kHz}$	5	—	50	100	
		10	—	20	40	
		15	—	15	30	
Input-Pulse Rise & Fall Time, $t_{r\phi}, t_{f\phi}$		5	Unlimited			
		10				
		15				
Max. Input-Pulse Frequency, $f_{\phi I}$ (External pulse source)		5	3.5	7	—	MHz
		10	8	16	—	
		15	12	24	—	
Input Capacitance, $C_I$	Any Input		—	5	7.5	pF
<b>Reset Operation</b>						
Propagation Delay Time, $t_{PHL}$		5	—	180	360	ns
		10	—	80	160	
		15	—	50	100	
Minimum Reset Pulse Width, $t_W$		5	—	60	120	
		10	—	30	60	
		15	—	20	40	



Fig. 8 - Typical propagation delay time ( $\phi_I$  to  $Q_4$  Output) as a function of load capacitance.

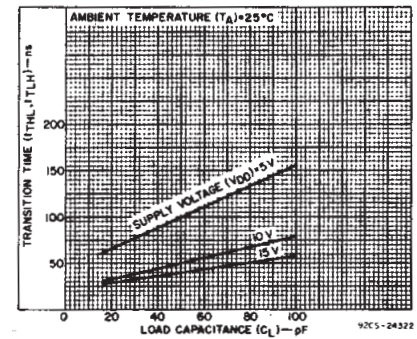

Fig. 9 - Typical transition time as a function of load capacitance.

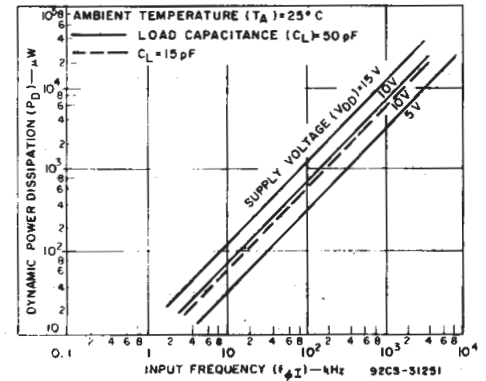

Fig. 10 - Typical dynamic power dissipation as a function of input frequency.



Fig. 11 - Dynamic power dissipation test circuit.



Fig. 12 - Typical RC circuit.

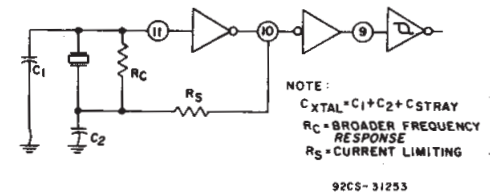

Fig. 13 - Typical crystal circuit.

# CD4060B Types

DYNAMIC ELECTRICAL CHARACTERISTICS at  $T_A = 25^\circ\text{C}$ , Input  $t_r, t_f = 20 \text{ ns}$ ,  $C_L = 50 \text{ pF}$ ,  $R_L = 200 \text{ k}\Omega$  [cont'd]

CHARACTERISTIC	TEST CONDITIONS	VDD (V)	LIMITS			UNITS	
			Min.	Typ.	Max.		
<b>RC Operation</b>							
Variation of Frequency (Unit-to-Unit)	$C_X = 200 \text{ pF}$ , $R_S = 560 \text{ k}\Omega$ , $R_X = 50 \text{ k}\Omega$	5	—	$23 \pm 10\%$	—	kHz	
		10	—	$24 \pm 10\%$	—		
		15	—	$25 \pm 10\%$	—		
Variation of Frequency with voltage change (Same Unit)	$C_X = 200 \text{ pF}$ , $R_S = 560 \text{ k}\Omega$ , $R_X = 50 \text{ k}\Omega$	5V to 10 V 10V to 15V	—	1.5 0.5	—	M $\Omega$	
$R_X$ max.	$C_X = 10 \text{ }\mu\text{F}$ $= 50 \text{ }\mu\text{F}$ $= 10 \text{ }\mu\text{F}$	5	—	—	20		
		10	—	—	20		
		15	—	—	10		
$C_X$ max.	$R_X = 500 \text{ k}\Omega$ $= 300 \text{ k}\Omega$ $= 300 \text{ k}\Omega$	5	—	—	1000	$\mu\text{F}$	
		10	—	—	50		
		15	—	—	50		
Maximum Oscillator Frequency*	$R_X = 5 \text{ k}\Omega$ $R_S = 30 \text{ k}\Omega$ $C_X = 15 \text{ pF}$	10	530	650	810	kHz	
		15	690	800	940		
Drive Current at Pin 9 (For Oscillator Design)	$I_{OL}$	$V_O = 0.4 \text{ V}$	5	0.16	0.35	—	mA
		$= 0.5 \text{ V}$	10	0.42	0.8	—	
		$= 1.5 \text{ V}$	15	1	2	—	
	$I_{OH}$	$V_O = 4.6 \text{ V}$	5	-0.16	-0.35	—	
		$= 9.5 \text{ V}$	10	-0.42	-0.8	—	
		$= 13.5 \text{ V}$	15	-1	-2	—	

\*RC oscillator applications are not recommended at supply voltages below 7 V for  $R_X < 50 \text{ k}\Omega$ .



Fig. 14 – Quiescent device current.

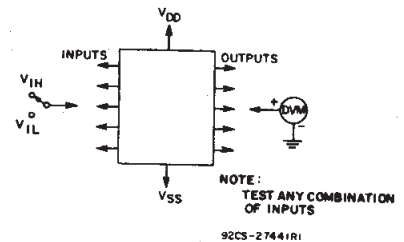

Fig. 15 – Input voltage.

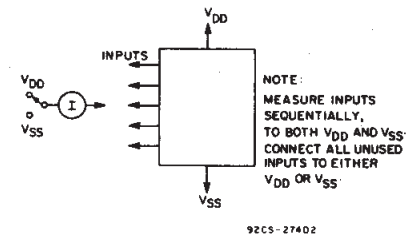
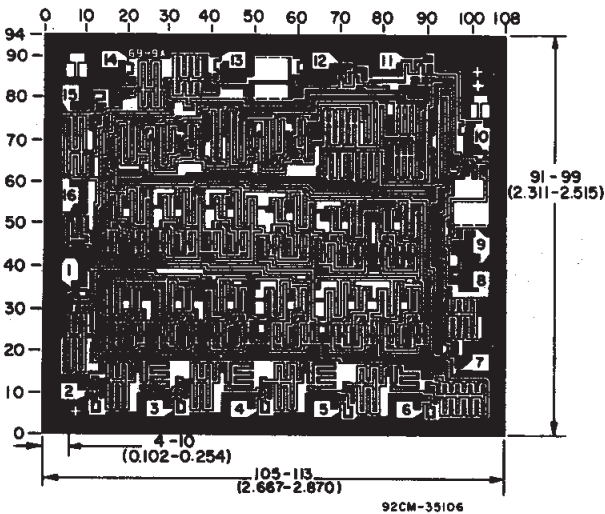

Fig. 16 – Input current.

3  
COMMERCIAL CMOS  
HIGH VOLTAGE ICs



Chip dimensions and pad layout for CD4060B

### TERMINAL DIAGRAM

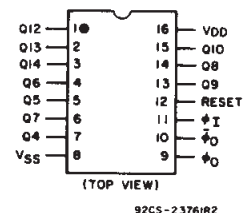

Dimensions in parentheses are in millimeters and are derived from the basic inch dimensions as indicated. Grid graduations are in mils ( $10^{-3}$  inch).

**PACKAGING INFORMATION**

Orderable Device	Status <sup>(1)</sup>	Package Type	Package Drawing	Pins	Package Qty	Eco Plan <sup>(2)</sup>	Lead/Ball Finish	MSL Peak Temp <sup>(3)</sup>
CD4060BE	ACTIVE	PDIP	N	16	25	Pb-Free (RoHS)	CU NIPDAU	Level-NC-NC-NC
CD4060BF	ACTIVE	CDIP	J	16	1	TBD	Call TI	Level-NC-NC-NC
CD4060BF3A	ACTIVE	CDIP	J	16	1	TBD	Call TI	Level-NC-NC-NC
CD4060BM	ACTIVE	SOIC	D	16	40	Green (RoHS & no Sb/Br)	CU NIPDAU	Level-1-260C-UNLIM
CD4060BM96	ACTIVE	SOIC	D	16	2500	Green (RoHS & no Sb/Br)	CU NIPDAU	Level-1-260C-UNLIM
CD4060BM96E4	ACTIVE	SOIC	D	16	2500	Green (RoHS & no Sb/Br)	CU NIPDAU	Level-1-260C-UNLIM
CD4060BME4	ACTIVE	SOIC	D	16	40	Green (RoHS & no Sb/Br)	CU NIPDAU	Level-1-260C-UNLIM
CD4060BMT	ACTIVE	SOIC	D	16	250	Green (RoHS & no Sb/Br)	CU NIPDAU	Level-1-260C-UNLIM
CD4060BMTE4	ACTIVE	SOIC	D	16	250	Green (RoHS & no Sb/Br)	CU NIPDAU	Level-1-260C-UNLIM
CD4060BNSR	ACTIVE	SO	NS	16	2000	Green (RoHS & no Sb/Br)	CU NIPDAU	Level-1-260C-UNLIM
CD4060BNSRE4	ACTIVE	SO	NS	16	2000	Green (RoHS & no Sb/Br)	CU NIPDAU	Level-1-260C-UNLIM
CD4060BPW	ACTIVE	TSSOP	PW	16	90	Green (RoHS & no Sb/Br)	CU NIPDAU	Level-1-260C-UNLIM
CD4060BPWE4	ACTIVE	TSSOP	PW	16	90	Green (RoHS & no Sb/Br)	CU NIPDAU	Level-1-260C-UNLIM
CD4060BPWR	ACTIVE	TSSOP	PW	16	2000	Green (RoHS & no Sb/Br)	CU NIPDAU	Level-1-260C-UNLIM
CD4060BPWRE4	ACTIVE	TSSOP	PW	16	2000	Green (RoHS & no Sb/Br)	CU NIPDAU	Level-1-260C-UNLIM

<sup>(1)</sup> The marketing status values are defined as follows:

**ACTIVE:** Product device recommended for new designs.

**LIFEBUY:** TI has announced that the device will be discontinued, and a lifetime-buy period is in effect.

**NRND:** Not recommended for new designs. Device is in production to support existing customers, but TI does not recommend using this part in a new design.

**PREVIEW:** Device has been announced but is not in production. Samples may or may not be available.

**OBSOLETE:** TI has discontinued the production of the device.

<sup>(2)</sup> Eco Plan - The planned eco-friendly classification: Pb-Free (RoHS) or Green (RoHS & no Sb/Br) - please check <http://www.ti.com/productcontent> for the latest availability information and additional product content details.

**TBD:** The Pb-Free/Green conversion plan has not been defined.

**Pb-Free (RoHS):** TI's terms "Lead-Free" or "Pb-Free" mean semiconductor products that are compatible with the current RoHS requirements for all 6 substances, including the requirement that lead not exceed 0.1% by weight in homogeneous materials. Where designed to be soldered at high temperatures, TI Pb-Free products are suitable for use in specified lead-free processes.

**Green (RoHS & no Sb/Br):** TI defines "Green" to mean Pb-Free (RoHS compatible), and free of Bromine (Br) and Antimony (Sb) based flame retardants (Br or Sb do not exceed 0.1% by weight in homogeneous material)

<sup>(3)</sup> MSL, Peak Temp. -- The Moisture Sensitivity Level rating according to the JEDEC industry standard classifications, and peak solder temperature.

**Important Information and Disclaimer:** The information provided on this page represents TI's knowledge and belief as of the date that it is provided. TI bases its knowledge and belief on information provided by third parties, and makes no representation or warranty as to the accuracy of such information. Efforts are underway to better integrate information from third parties. TI has taken and continues to take reasonable steps to provide representative and accurate information but may not have conducted destructive testing or chemical analysis on

incoming materials and chemicals. TI and TI suppliers consider certain information to be proprietary, and thus CAS numbers and other limited information may not be available for release.

In no event shall TI's liability arising out of such information exceed the total purchase price of the TI part(s) at issue in this document sold by TI to Customer on an annual basis.

J (R-GDIP-T\*\*)

14 LEADS SHOWN

CERAMIC DUAL IN-LINE PACKAGE



DIM \ PINS **	14	16	18	20
A	0.300 (7,62) BSC	0.300 (7,62) BSC	0.300 (7,62) BSC	0.300 (7,62) BSC
B MAX	0.785 (19,94)	.840 (21,34)	0.960 (24,38)	1.060 (26,92)
B MIN	—	—	—	—
C MAX	0.300 (7,62)	0.300 (7,62)	0.310 (7,87)	0.300 (7,62)
C MIN	0.245 (6,22)	0.245 (6,22)	0.220 (5,59)	0.245 (6,22)



4040083/F 03/03

- NOTES:
- A. All linear dimensions are in inches (millimeters).
  - B. This drawing is subject to change without notice.
  - C. This package is hermetically sealed with a ceramic lid using glass frit.
  - D. Index point is provided on cap for terminal identification only on press ceramic glass frit seal only.
  - E. Falls within MIL STD 1835 GDIP1-T14, GDIP1-T16, GDIP1-T18 and GDIP1-T20.

N (R-PDIP-T\*\*)

PLASTIC DUAL-IN-LINE PACKAGE

16 PINS SHOWN



- NOTES:
- A. All linear dimensions are in inches (millimeters).
  - B. This drawing is subject to change without notice.
  - Falls within JEDEC MS-001, except 18 and 20 pin minimum body length (Dim A).
  - The 20 pin end lead shoulder width is a vendor option, either half or full width.



D (R-PDSO-G16)

PLASTIC SMALL-OUTLINE PACKAGE



- NOTES:
- A. All linear dimensions are in inches (millimeters).
  - B. This drawing is subject to change without notice.
  - C. Body dimensions do not include mold flash or protrusion not to exceed 0.006 (0,15).
  - D. Falls within JEDEC MS-012 variation AC.

# MECHANICAL DATA

NS (R-PDSO-G\*\*)

PLASTIC SMALL-OUTLINE PACKAGE

14-PINS SHOWN



- NOTES:
- A. All linear dimensions are in millimeters.
  - B. This drawing is subject to change without notice.
  - C. Body dimensions do not include mold flash or protrusion, not to exceed 0,15.

PW (R-PDSO-G\*\*)

PLASTIC SMALL-OUTLINE PACKAGE

14 PINS SHOWN



4040064/F 01/97

- NOTES: A. All linear dimensions are in millimeters.  
 B. This drawing is subject to change without notice.  
 C. Body dimensions do not include mold flash or protrusion not to exceed 0,15.  
 D. Falls within JEDEC MO-153

## IMPORTANT NOTICE

Texas Instruments Incorporated and its subsidiaries (TI) reserve the right to make corrections, modifications, enhancements, improvements, and other changes to its products and services at any time and to discontinue any product or service without notice. Customers should obtain the latest relevant information before placing orders and should verify that such information is current and complete. All products are sold subject to TI's terms and conditions of sale supplied at the time of order acknowledgment.

TI warrants performance of its hardware products to the specifications applicable at the time of sale in accordance with TI's standard warranty. Testing and other quality control techniques are used to the extent TI deems necessary to support this warranty. Except where mandated by government requirements, testing of all parameters of each product is not necessarily performed.

TI assumes no liability for applications assistance or customer product design. Customers are responsible for their products and applications using TI components. To minimize the risks associated with customer products and applications, customers should provide adequate design and operating safeguards.

TI does not warrant or represent that any license, either express or implied, is granted under any TI patent right, copyright, mask work right, or other TI intellectual property right relating to any combination, machine, or process in which TI products or services are used. Information published by TI regarding third-party products or services does not constitute a license from TI to use such products or services or a warranty or endorsement thereof. Use of such information may require a license from a third party under the patents or other intellectual property of the third party, or a license from TI under the patents or other intellectual property of TI.

Reproduction of information in TI data books or data sheets is permissible only if reproduction is without alteration and is accompanied by all associated warranties, conditions, limitations, and notices. Reproduction of this information with alteration is an unfair and deceptive business practice. TI is not responsible or liable for such altered documentation.

Resale of TI products or services with statements different from or beyond the parameters stated by TI for that product or service voids all express and any implied warranties for the associated TI product or service and is an unfair and deceptive business practice. TI is not responsible or liable for any such statements.

Following are URLs where you can obtain information on other Texas Instruments products and application solutions:

<b>Products</b>		<b>Applications</b>	
Amplifiers	<a href="http://amplifier.ti.com">amplifier.ti.com</a>	Audio	<a href="http://www.ti.com/audio">www.ti.com/audio</a>
Data Converters	<a href="http://dataconverter.ti.com">dataconverter.ti.com</a>	Automotive	<a href="http://www.ti.com/automotive">www.ti.com/automotive</a>
DSP	<a href="http://dsp.ti.com">dsp.ti.com</a>	Broadband	<a href="http://www.ti.com/broadband">www.ti.com/broadband</a>
Interface	<a href="http://interface.ti.com">interface.ti.com</a>	Digital Control	<a href="http://www.ti.com/digitalcontrol">www.ti.com/digitalcontrol</a>
Logic	<a href="http://logic.ti.com">logic.ti.com</a>	Military	<a href="http://www.ti.com/military">www.ti.com/military</a>
Power Mgmt	<a href="http://power.ti.com">power.ti.com</a>	Optical Networking	<a href="http://www.ti.com/opticalnetwork">www.ti.com/opticalnetwork</a>
Microcontrollers	<a href="http://microcontroller.ti.com">microcontroller.ti.com</a>	Security	<a href="http://www.ti.com/security">www.ti.com/security</a>
		Telephony	<a href="http://www.ti.com/telephony">www.ti.com/telephony</a>
		Video & Imaging	<a href="http://www.ti.com/video">www.ti.com/video</a>
		Wireless	<a href="http://www.ti.com/wireless">www.ti.com/wireless</a>

Mailing Address: Texas Instruments  
Post Office Box 655303 Dallas, Texas 75265