

SSA3000X Plus Spectrum Analyzer

User Manual

UM0703P-E01A

Copyright and Declaration

Copyright

SIGLENT TECHNOLOGIES CO., LTD All Rights Reserved.

Trademark Information

SIGLENT is the registered trademark of **SIGLENT TECHNOLOGIES CO., LTD**

Declaration

- ◆ **SIGLENT** products are protected by patent law worldwide
- ◆ **SIGLENT** reserves the right to modify or change parts of or all the specifications or pricing policies at company's sole decision.
- ◆ Information in this publication replaces all previously corresponding material.
- ◆ Any way of copying, extracting or translating the contents of this manual is not allowed without the permission of **SIGLENT**.
- ◆ **SIGLENT** will not be responsible for losses caused by either incidental or consequential in connection with the furnishing, use or performance of this manual as well as any information contained.

Product Certification

SIGLENT guarantees this product conforms to the national and industrial standards in China as well as the ISO9001: 2008 standard and the ISO14001: 2004 standard. Other international standard conformance certification is in progress.

Safety Information

General Safety Summary

Carefully read the following safety precautions to avoid any personal injury or damage to the instrument and any products connected to it. To avoid potential hazards, please use the instrument as specified.

Use Proper AC Power Line

Only the power cord designed for the instrument and authorized by the local country should be used.

Ground the Instrument

The instrument is grounded through the protective earth conductor of the power line. To avoid electric shock, please make sure the instrument is grounded correctly before connecting its input or output terminals.

Connect the Probe Correctly.

If a probe is used, do not connect the ground lead to high voltage since it has an isobaric electric potential as the ground.

Look Over All Terminals' Ratings

To avoid fire or electric shock, please look over all ratings and sign instruction of the instrument. Before connecting the instrument, please read the manual carefully to gain more information about the ratings.

Use Proper Overvoltage Protection

Make sure that no over-voltage (such as that caused by a thunderstorm) can reach the product, or else the operator might be exposed to danger of electrical shock.

Electrostatic Prevention

Operate the instrument in an electrostatic discharge protective area environment to avoid damages induced by static discharge. Always ground both the internal and external conductors of the cable to release static before connecting.

Maintain Proper Ventilation

Inadequate ventilation may cause increasing of the instrument's temperature, which will eventually damage the instrument. So keep well ventilated and inspect the intake and fan regularly.

Avoid Exposed Circuit or Components

Do not touch exposed contacts or components when the power is on.

Do Not Operate Without Covers

Do not operate the instrument with covers or panels removed.

Use proper Fuse.

Use Only the Specified Fuse.

Keep Product Surfaces Clean and Dry.

To avoid the influence of dust and/or moisture in the air, please keep the surface of the device clean and dry.

Do Not Operate in Wet Conditions.

In order to avoid short circuiting to the interior of the device or electric shock, please do not operate the instrument in a humid environment.

Do Not Operate in an Explosive Atmosphere.

In order to avoid damage to the device or personal injury, it is important to operate the device away from an explosive atmosphere.

Any parts of the device and its accessories are not allowed to be changed or replaced, other than authorized by the manufacturer or his agent.

Make sure not to position the equipment so that it is difficult to operate the disconnecting device (detachable plug).

Safety Terms and Symbols

Terms in this Manual. These terms may appear in this manual:



WARNING

Warning statements indicate the conditions or practices that could result in injury or loss of life.



CAUTION

Caution statements indicate the conditions or practices that could result in damage to this product or other property.

Terms on the product:

DANGER Indicates direct injuries or hazards that may happen.

WARNING Indicates potential injuries or hazards that may happen.

CAUTION Indicates potential damages to the instrument or other property that may happen.

Symbols on the product:**Hazardous
Voltage****protective Earth
Terminal****Warning****Test
Ground****Power Switch**

If find such symbols on the product, consult the manual to find out the nature of the potential hazard and the actions which have to be taken.

Measurement Category

Measurement Categories

This analyzer can make measurements in other circuits that are not directly connected to mains.



WARNING

This analyzer can only be used for measurements within its specified measurement categories.

Not to use the product for measurements within other measurement categories, such as CAT II, CAT III, CAT IV.

Not to use the equipment for measurements on mains circuits

Measurement Category Definitions

Measurement category II is for measurements performed on circuits directly connected to the low voltage installation. Examples are measurements on household appliances, portable tools and similar equipment.

Measurement category III is for measurements performed in the building installation. Examples are measurements on distribution boards, circuit-breakers, wiring, including cables, bus-bars, junction boxes, switches, socket-outlets in the fixed installation, and equipment for industrial use and some other equipment, for example. Stationary motors with permanent connection to the fixed installation.

Measurement category IV is for measurements performed at the source of the low-voltage installation. Examples are electricity meters and measurements on primary over current protection devices and ripple control units.

Working Environment

Temperature

Operating: 0°C to +40°C

Non-operation: -20°C to +70°C

Humidity

Under +35°C: ≤80% relative humidity

+35°C to +40°C: ≤60% relative humidity



WARNING

To avoid short circuit inside the instrument or electric shock, please do not operate in humid environment.

Altitude

Operating: less than 3 km

Non-operation: less than 15 km

Degree of protection

IP20

Installation (overvoltage) Category

This product is powered by mains conforming to installation (overvoltage) category II.



WARNING

Make sure that no overvoltage (such as that caused by thunderbolt) can reach the product, or else the operator might expose to danger of electric shock.

Installation (overvoltage) Category Definitions

Installation (overvoltage) category I refers to signal level which is applicable to equipment measurement terminals connected to the source circuit. In these terminals, precautions are done to limit the transient voltage to the corresponding low level.

Installation (overvoltage) category II refers to the local power distribution level which is applicable to equipment connected to the AC line (AC power).

Ventilation Requirement

This analyzer uses fan to force cooling. Please make sure that the air intake and exhaust areas are free from obstructions and have free air. When using the analyzer in a bench-top or rack setting, provide at least 10 cm clearance beside, above and behind the instrument for adequate ventilation.

**WARNING**

Inadequate ventilation may cause temperature increase which would damage the instrument. So please keep the instrument well ventilated during operation and inspect the intake and fan regularly.

General Care and Cleaning

Care

Do not store or leave the instrument in direct sunshine for long periods of time.

**WARNING**

To avoid damages to the instrument or probe, please do not leave them in fog, liquid, or solvent.

Cleaning

Please perform the following steps to clean the instrument and probe regularly according to its operating conditions.

1. Disconnect the instrument from all power sources, and then clean it with a soft wet cloth.
2. Clean the loose dust on the outside of the instrument and probe with a soft cloth. When cleaning the LCD, take care to avoid scarifying it.

**WARNING**

To avoid damages to the surface of the instrument and probe, please do not use any corrosive liquid or chemical cleanser.

**WARNING**

Make sure that the instrument is completely dry before restarting it to avoid short circuits or personal injuries.

L'information de sûreté

Résumé général de sûreté

Lisez soigneusement les mesures de sécurité suivantes pour éviter n'importe quelles blessures ou les dommages à l'instrument et à tous les produits se sont reliés à eux. Pour éviter des risques, utilisez svp l'instrument comme indiqué.

Employez la ligne à haute tension appropriée

Seulement le cordon de secteur conçu pour l'instrument et autorisé par le pays local a pu être employé.

A rectifié l'instrument.

L'instrument est fondu par le conducteur protecteur de terra de la ligne à haute tension. Pour éviter la décharge électrique, le conducteur moulu doit être relié à la terre. Assurez-vous que l'instrument est fondu correctement avant de relier ses bornes d'entrée ou de rendement.

Reliez le fil de signal correctement.

Le potentiel de l'au sol de fil de signal est égal à la terre, ainsi ne relie pas le fil de signal à une tension.

Regardez estimations au-dessus de toutes les bornes des'

Pour éviter le feu ou la décharge électrique, regardez svp au-dessus de toutes les estimations et instruction de signe de l'instrument. Avant de relier l'instrument, lisez svp le manuel soigneusement pour obtenir plus d'informations sur les estimations.

Employez la protection appropriée de surtension

Assurez-vous qu'aucune surtension (comme cela provoqué par un orage) ne peut atteindre le produit, ou bien l'opérateur pourrait exposer au danger du choc électrique.

Empêchement électrostatique

Fonctionnez dans un environnement protecteur de secteur de décharge électrostatique pour éviter des dommages induits par décharge statique. A toujours rectifié les conducteurs internes et externes du câble pour libérer la charge statique avant de se relier.

La ventilation insatisfaisante de ventilation

bonne de subsistance peut causer l'augmentation de la température, qui endommagera par la suite l'instrument. Gardez ainsi la ventilation bonne et inspectez la prise et éventez régulièrement.

Évitez le circuit ou les composants exposés

ne touchent pas les contacts ou les composants exposés quand le courant passe.

Employez l'utilisation appropriée

de fusible seulement le fusible indiqué.

Ne fonctionnez pas sans couvertures

n'actionnent pas l'instrument des couvertures ou des panneaux étant coupés.

Ne fonctionnez pas avec des échecs suspectés.

Si vous suspectez les dommages se produisent à l'instrument, l'ont inspecté par le personnel de service qualifié avant d'autres opérations. N'importe quel entretien, ajustement ou remplacement particulièrement aux circuits ou aux accessoires doivent être exécutés par le personnel autorisé par **SIGLENT**.

Ne fonctionnez pas en conditions humides.

Afin d'éviter de court-circuiter à l'intérieur du dispositif ou de la décharge électrique, svp ne fonctionnez pas dans un environnement humide.

Do Not Operate in an Explosive Atmosphere.

Ne fonctionnez pas dans une atmosphère explosive.

Afin d'éviter d'endommager le dispositif ou les blessures, il est important d'utiliser le dispositif loin à partir d'une atmosphère explosive.

Maintenez les surfaces de produit propres et sèches.

Pour éviter l'influence de la poussière et/ou de l'humidité en air, maintenez svp la surface du dispositif propre et sèche.

En manipulant la sûreté

manipulez svp avec soin pendant le transport pour éviter d'endommager des boutons, des interfaces de bouton et d'autres parties sur les panneaux.

Le corps ou l'opérateur responsable devrait se référer au manuel d'instruction pour préserver la protection se permettent par l'équipement. Si l'équipement est utilisé en quelque sorte non indiqué par le fabricant, la protection fournie par l'équipement peut être altérée.

On ne permet à aucune pièce du dispositif et de ses accessoires d'être changé ou remplacé, autre qu'autorisé par le fabricant ou son agent.

Pas placez l'équipement de sorte qu'il soit difficile d'utiliser le dispositif débranchant (prise détachable).

Limites et symboles de sûreté

Limites en ce manuel. Ces limites peuvent apparaître en ce manuel :



Les rapports

d'avertissement D'AVERTISSEMENT indiquent les conditions ou les pratiques qui pourraient avoir comme conséquence les dommages ou la perte de la vie.



Les rapports

d'attention d'ATTENTION indiquent les conditions ou les pratiques qui pourraient avoir comme conséquence les dommages à ce produit ou à toute autre propriété.

Limites sur le produit. Ces limites peuvent apparaître sur le produit :

Le DANGER indique les dommages ou les risques directs qui peuvent se produire.

Dommages ou risques potentiels de WARNING indiqués qui peuvent se produire.

L'ATTENTION indique des dommages potentiels à l'instrument ou à toute autre propriété qui peuvent se produire.

Si la trouvaille de tels symboles sur le produit, consultez le manuel pour découvrir la nature du risque et des actions qui doivent être pris.

Symboles sur le produit. Ces symboles peuvent apparaître sur le produit :



Dangereux
Tension



Protecteur
Au sol de la terre



Avertissement



Châssis
Ground



Puissance
Switch

Catégorie de mesure

Les analyzeurs peuvent faire des mesures dans d'autres circuits qui ne sont pas directement reliés aux forces. Pour ne pas employer le produit pour des mesures dans d'autres catégories de mesure, telles que le CAT II, CAT III, CAT IV.

Ne pas utiliser l'équipement pour des mesures sur des forces circuite, pour ne pas utiliser l'équipement pour des mesures sur la tension excèdent la gamme de tension décrivent dans le manuel.



Les rapports

cet analyzeurs peut seulement être employé pour des mesures dans ses catégories indiquées de mesure.

La catégorie II de mesure

de définitions de catégorie de mesure est pour des mesures effectuées sur des circuits directement reliés à l'installation de basse tension. Les exemples sont des mesures sur des appareils électroménagers, des outils portatifs et l'équipement semblable.

La catégorie III de mesure est pour des mesures effectuées dans l'installation de bâtiment. Les exemples sont des mesures sur des conseils de distribution, des disjoncteurs, le câblage, y compris des câbles, des barres omnibus, des boîtes de jonction, des commutateurs, des douille-sorties dans l'installation fixe, et l'équipement à l'utilisation industrielle et à un autre équipement,

par exemple. Moteurs stationnaires avec le raccordement permanent à l'installation fixe.

La catégorie IV de mesure est pour des mesures effectuées à la source d'installation de basse tension. Les exemples sont des mètres et des mesures de l'électricité sur les dispositifs de protection d'excédent primaire et les unités de commande courants d'ondulation.

Environnement de fonctionnement

Température

En fonctionnement: 0 à + 40

Non-fonctionnement: -20 à + 70

Humidité

Moins de + 35: humidité relative $\leq 80\%$

+ 35 à + 40 °C: humidité relative $\leq 60\%$



EN AVERTISSANT

d'éviter le court-circuit à l'intérieur de l'instrument ou de la décharge électrique, svp ne fonctionnez pas dans l'environnement humide.

Opération

d'altitude : moins de 3 kilomètres

de non-fonctionnement : moins de 15 kilomètres

Degré de protection

IP20

La catégorie d'installation (surtension)

ce produit est actionnée par des forces conformément à la catégorie II. d'installation (surtension).



EN AVERTISSANT

assurez-vous qu'aucune surtension (comme cela provoqué par coup de foudre) ne peut atteindre le produit, ou bien l'opérateur pourrait exposer au danger de la décharge électrique.

La catégorie II d'installation de définitions de catégorie d'installation (surtension) (surtension) se rapporte au niveau local de distribution d'énergie qui est applicable à l'équipement relié à la ligne à C.A. (courant alternatif).

Condition de ventilation

This analyzer uses fan to force cooling. Please make sure that the air intake and exhaust areas are free from obstructions and have free air. When using the analyzer in a bench-top or rack setting, provide at least 10 cm clearance beside, above and behind the instrument for adequate ventilation.

Cet analyser utilise le ventilateur pour forcer le refroidissement. Veuillez s'assurer que les secteurs d'entrée et d'échappement d'air sont exempts des obstructions et ont l'air libre. À l'aide de l'analyser dans un mettre hors jeu-dessus ou un arrangement de support, fournissez au moins le dégagement de 10 centimètres près, au-dessus et derrière de l'instrument pour à ventilation proportionnée.



La ventilation insatisfaisante peut causer l'augmentation de la température qui endommagerait l'instrument. Veuillez ainsi la subsistance l'instrument bien aéré lors du fonctionnement et inspectez la prise et éventez régulièrement.

Soin général et nettoyage

Ne stockez pas ou ne laissez pas l'instrument en soleil direct pendant de longues périodes.



Pour éviter d'endommager l'instrument, svp ne les laissez pas dans le brouillard, le liquide, ou le dissolvant.

nettoyage

Veuillez exécuter les étapes suivantes pour nettoyer l'instrument régulièrement selon ses conditions de fonctionnement.

1. Démontez l'instrument de toutes les sources d'énergie, et puis nettoyez-le avec un tissu humide mou.
2. Nettoyez la poussière lâche sur l'extérieur de l'instrument avec un tissu mou. En nettoyant l'affichage à cristaux liquides, salut pour éviter de le scarifier.



Pour éviter d'endommager la surface de l'instrument, svp n'utilisez aucune épierreuse corrosive de liquide ou de produit chimique.



Assurez-vous que l'instrument est complètement sec avant de le remettre en marche pour éviter des courts-circuits ou des blessures.

Allgemeine Sicherheitshinweise

Um Verletzungen oder Schäden am Gerät und den damit verbundenen Produkten zu vermeiden, lesen Sie die folgenden Sicherheitshinweise sorgfältig durch.

Um mögliche Gefahren zu vermeiden, verwenden Sie bitte das Gerät wie angegeben.

Wartungsarbeiten an diesem Gerät dürfen nur von qualifiziertem Reparaturpersonal durchgeführt werden.

Verwendung eines geeigneten Netzkabels

Verwenden Sie nur das für das Gerät vorgesehene und von den örtlichen Behörden zugelassene Netzkabel.

Erdung des Gerätes

Das Gerät ist über den Schutzleiter des Netzkabels geerdet. Um einen elektrischen Schlag zu vermeiden, vergewissern Sie sich bitte, bevor Sie seine Eingangs- oder Ausgangsklemmen anschließen, dass das Gerät korrekt geerdet ist.

Anschluss der Signalleitung

Die Masse der Signalleitung ist auf dem gleichen Potential wie die Erdung des Gerätes. Schließen Sie daher die Masseleitung nie an eine Hochspannung an. Berühren Sie keine freiliegenden Kontakte oder Komponenten.

Verschaffen Sie sich einen Überblick über alle Anschluss-Ratings

Um Brände oder Stromschläge zu vermeiden, lesen Sie bitte alle Bemerkungen und Anweisungen des Gerätes. Bevor Sie das Gerät anschließen, lesen Sie bitte das Handbuch sorgfältig durch, um weitere Informationen über die Nennleistungen zu erhalten.

Betreiben Sie kein Gerät, bei dem der Verdacht besteht, dass es defekt ist.

Wenn Sie vermuten, dass das Produkt beschädigt ist, lassen Sie es bitte von qualifiziertem Fachpersonal überprüfen. Vermeiden Sie den Kontakt mit freiliegenden Stromkreisen oder Drähten. Berühren Sie keine freiliegenden Kontakte oder Komponenten, wenn das Gerät eingeschaltet ist.

Verwenden Sie einen geeigneten Überspannungsschutz

Stellen Sie sicher, dass keine Überspannung (z.B. durch ein Gewitter) auf das Produkt gelangen kann, da sonst der Bediener der Gefahr eines Stromschlags ausgesetzt sein kann.

Nicht ohne Abdeckungen betreiben

Betreiben Sie das Gerät nicht bei abgenommenen Abdeckungen oder Platten.

Halten Sie die Oberfläche des Gerätes sauber und trocken.

Nicht unter nassen/feuchten Bedingungen betreiben.

Betreiben Sie das Gerät nicht in einer explosiven Atmosphäre.

Vermeiden Sie es, dieses Gerät einem Feuer auszusetzen.

Sicherheitshinweise und Symbole

In diesem Produkt verwendete Begriffe. Diese Begriffe können im Produkt erscheinen:

GEFAHR weist auf eine mögliche, sofortige und direkte Verletzung oder Gefährdung hin.

WARNUNG weist auf möglicherweise auftretende Verletzungen oder Gefahren hin

VORSICHT weist auf möglicherweise auftretende Schäden am Gerät oder anderen Gegenständen hin

In diesem Produkt verwendete Symbole. Diese Symbole können auf dem Produkt erscheinen:



Gefährliche
Spannung



Schutzerde



Sicherheitswarnung



Erdung



Netzschalter

Contents

Copyright and Declaration	II
Safety Information	III
General Safety Summary	III
Safety Terms and Symbols	IV
Measurement Category	V
Working Environment	VI
Ventilation Requirement	VII
General Care and Cleaning	VII
L'information de sûreté	VIII
Résumé général de sûreté	VIII
Limites et symboles de sûreté	X
Catégorie de mesure	XI
Environnement de fonctionnement	XII
Condition de ventilation	XII
Soin général et nettoyage	XIII
Allgemeine Sicherheitshinweise	XIV
Sicherheitshinweise und Symbole	XV
Chapter 1 Quick Start	2
1.1 General Inspection	3
1.2 Appearance and Dimension	3
1.3 Preparing for Use	4
1.3.1 Adjust the Supporting Legs	4
1.3.2 Connect to AC Power Supply	4
1.4 Front Panel	5
1.4.1 Front Panel Function Keys	5
1.4.2 Front Panel Key Backlight	7
1.4.3 Using the Numeric Keyboard	7
1.4.4 Front Panel Connectors	8
1.5 Rear Panel	10
1.6 User Interface	12
1.7 Firmware Operation	14
1.7.1 Check System Information	14
1.7.2 Load Option	14
1.7.3 Firmware Upgrade	14
1.8 Touch Operation	14
1.9 Remote Control	15
1.10 Using Built-in Help	15
1.11 Using the Security Lock	16
Chapter 2 Spectrum Analyzer	17
2.1 Basic Settings	18
2.1.1 Frequency	18
2.1.2 Span	23
2.1.3 Amplitude	24

2.1.4	Auto Tune	28
2.2	Sweep and Functions	30
2.2.1	BW	30
2.2.2	Trace	32
2.2.3	Detect	34
2.2.4	Sweep	35
2.2.5	Trigger	37
2.2.6	Limit	38
2.2.7	TG (Tracking Generator)	39
2.2.8	Demod	42
2.3	Marker	44
2.3.1	Marker	44
2.3.2	Marker ->	47
2.3.3	Marker Fn	48
2.3.4	Peak	50
2.4	Measurement	53
2.4.1	Meas	53
2.4.2	Meas setup	54
Chapter 3	Modulation Analyzer	64
3.1	Basic Settings	65
3.1.1	Frequency	65
3.2	Measurement	65
3.2.1	Digital Modulation Analysis	65
3.2.2	Analog Modulation Analysis	69
3.3	Sweep and Functions	70
3.3.1	Trigger	70
3.3.2	Sweep	71
Chapter 4	System Settings	72
4.1	System	72
4.1.1	Language	72
4.1.2	Power On/Preset	72
4.1.3	Interface	73
4.1.4	Calibration	74
4.1.5	System Info	74
4.1.6	Date and Time	75
4.1.7	Self Test	76
4.2	Display	76
4.2.1	Grid Brightness	76
4.2.2	Screenshot	76
4.2.3	Touch Settings	77
4.2.4	Power Saving	78
4.2.5	Annotation	78
4.2.6	Display Line	78
4.3	File	79
4.3.1	Browser	79

4.3.2	Open/Load	79
4.3.3	Back	79
4.3.4	View Type	79
4.3.5	Save Type	79
4.3.6	Save	80
4.3.7	Create Folder	80
4.3.8	Operate	80
4.4	Shortcut Key	81
4.4.1	Preset	81
4.4.2	Couple	87
4.4.3	Help	88
4.4.4	Save	88
Chapter 5	Programming Overview	89
5.1	Remotely Operating the Analyzer	89
5.1.1	USB: Connecting the Analyzer via the USB Device port	89
5.1.2	LAN: Connecting the Analyzer via the LAN port	89
5.1.3	GPIB: Connecting the Analyzer via the USB-Host port	90
5.2	Build Communication	91
5.2.1	Build Communication Using VISA	91
5.2.2	Build Communication Using Sockets/Telnet	93
5.3	Remote Control Capabilities	94
5.3.1	User-defined Programming	94
5.3.2	Send SCPI Commands via NI MAX	94
5.3.3	Easy Spectrum Software	96
5.3.1	Web Control	97
Chapter 6	Service and Support	98
6.1	Service Summary	98
6.2	Troubleshooting	98
6.3	Contact Us	100

Chapter 1 Quick Start

This chapter guides users to quickly get familiar with the appearance, dimensions, front/rear panel and the user interface, as well as announcements during the first use of the analyzer.

Subjects in this chapter:

- ◆ General Inspection
- ◆ Appearance and Dimension
- ◆ Preparing for Use
- ◆ Front Panel
- ◆ Rear Panel
- ◆ User Interface
- ◆ Firmware Operation
- ◆ Touch Operation
- ◆ Remote Control
- ◆ Using Built-in Help
- ◆ Using the Security Lock

1.1 General Inspection

1. Inspect the shipping container

Keep the damaged shipping container or cushioning material until the contents of the shipment have been completely checked and the instrument has passed both electrical and mechanical tests.

The consigner or carrier will be responsible for damages to the instrument resulting from shipment.

SIGLENT will not provide free maintenance or replacement.

2. Inspect the instrument

If the instrument is found to be damaged, defective or fails in electrical or mechanical tests, please contact **SIGLENT**.

3. Check the accessories

Please check the accessories according to the packing list in the box. If the accessories are incomplete or damaged, please contact your **SIGLENT** sales representative.

1.2 Appearance and Dimension

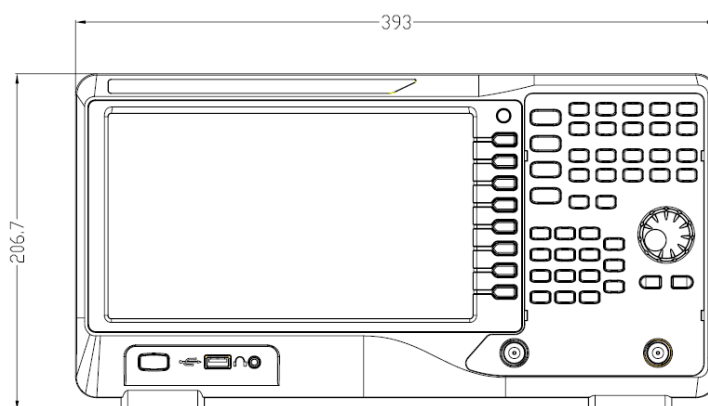

Figure 1-1 Front View

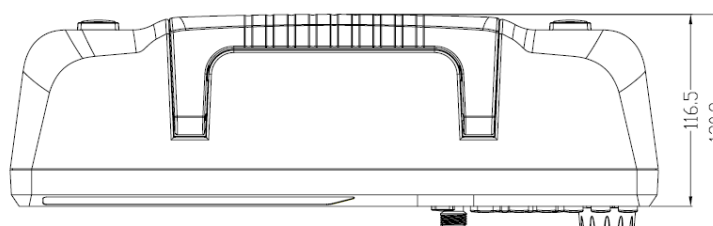

Figure 1-2 Top View

1.3 Preparing for Use

1.3.1 Adjust the Supporting Legs

Adjust the supporting legs properly to use them as stands to tilt the analyzer upwards for stable placement as well as easier operation and observation of the instrument display.

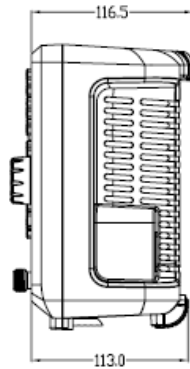

Figure 1-3 before adjusting

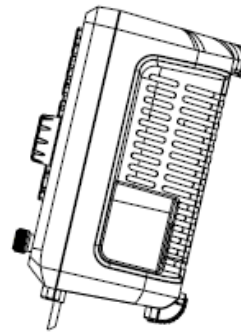

Figure 1-4 after adjusting

1.3.2 Connect to AC Power Supply

The spectrum analyzer accepts 100-240V, 50/60Hz or 100-120V 400Hz AC power supply. Please use the provided power cord to connect the instrument to the power source as shown in the figure below. Before powering on, make sure the analyzer is protected by a fuse.

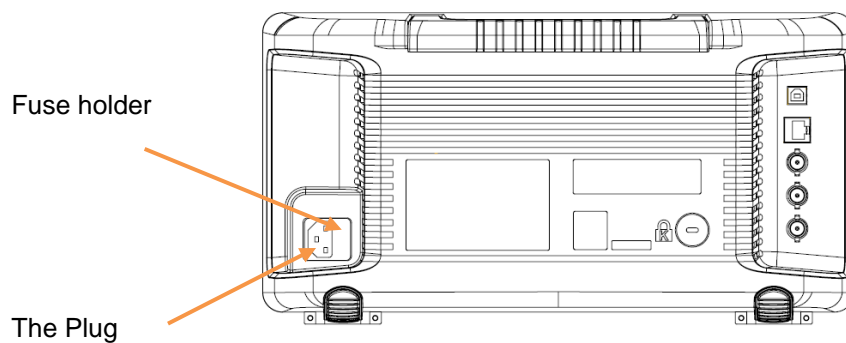

Figure 1-5 Power Cord Connection

1.4 Front Panel



Figure 1-6 the Front Panel

Table 1-1 Front Panel Description

NO.	Description	NO.	Description
1	User Graphical Interface, touch support	7	RF Input
2	Menu Control Keys	8	TG Output
3	Function Keys	9	3.5 mm Earphone interface
4	Knob	10	USB Host
5	Numeric / Letter Keyboard	11	Power Switch
6	Arrow Keys		

1.4.1 Front Panel Function Keys

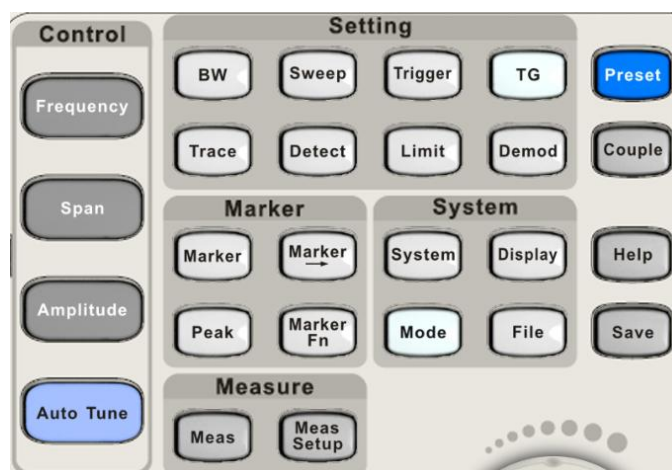

Figure 1-7 Function Keys area

Table 1-2 Function keys description

Control Keys	Description
Frequency	Set the parameters of frequency, and Peak→CF, CF→Step.
Span	Set the parameters of span, and X-scale (Log-Linear) setup.
Amplitude	Set the parameters of amplitude, including Ref Level, Attenuator, Preamp, etc.; and Correction setup.
Auto Tune	Scan the full span rapidly and move the biggest signal to center freq, and automatically sets the optimal parameters according to the signal.
Setting Keys	Description
BW	Set the parameters of RBW and VBW, Average Type (Log power, Power, Voltage).
Trace	Select Trace, Trace setup and Trace math.
Sweep	Set the parameters of sweep, and EMI QPD Dwell Time.
Detect	Select the detector type for each trace independently.
Trigger	Select triggers in Free Trigger, Video Trigger and External Trigger.
Limit	Set the Pass\Fail Limit.
TG	Set the parameters of tracking generator. Including TG Level, TG Level offset Normalization setup. The backlight LED is on when TG source is working.
Demod	Set the demodulation parameters of the AM and FM for audio listening.
Marker Keys	Description
Marker	Set the Markers and Marker Table.
Marker->	Set other system parameters on the basis of the current marker's value.
Marker Fn	Special functions of the marker such as noise marker, N dB bandwidth measurement and frequency counter.
Peak	Search for the peak signal, peak search configuration and peak table.
Meas Keys	Description
Meas	In spectrum analyzer mode, selects the Advanced Measurement function. In non-spectrum analyzer mode, select corresponding settings.
Meas Setup	Set the measurement parameters.
System Keys	Description
System	Set the system parameters.
Mode	Select the working modes.
Display	Set the display parameters.
File	Use the file system and files.
Shortcut Keys	Description
Preset	Sets the system to certain status.
Couple	Set the parameters of some functions between auto and manual.
Help	Turn on the built-in help.
Save	Save Shortcut Key.

1.4.2 Front Panel Key Backlight

The on/off state and the color of the backlights of some keys at the front panel indicate the working state of the analyzer. The states are as listed below.

1. Power Switch

- ◆ Flash on and off alternatively, in a “breathing” state: indicate the unit is in stand-by.
- ◆ Constant on: indicates the instrument is in normal operating state.

2. Mode

When the function is **Spectrum Analyzer**, the backlight turns off. When in other modes, the backlight turns on.

3. TG

When the **TG** source is on, the backlight of **TG** turns on and turns off when the function is off.

1.4.3 Using the Numeric Keyboard

The analyzer provides a numeric keyboard at the front panel. The numeric keyboard supports English uppercase/lowercase characters, numbers and common symbols (including decimal point, #, space and +/-) and are mainly used to edit file or folder names and set parameters.

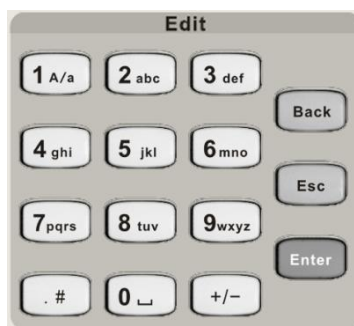

Figure 1-8 Numeric Keyboards

1. +/-

In number input, set the sign of number; in file input, switch in number and letter.

2. 1 A/a

In number input, enter number 1; in file input, switch between uppercase and lowercase letter.

3. .

In number input, enter a decimal point. In English input, enter special characters.

4. Back

In parameter editing, press this key to delete the character on the left of the cursor.

5. **Esc**

- ◆ During parameter editing process, press this key to clear the inputs in the active function area and exit parameter input.
- ◆ When the instrument is in remote mode, use this key to return to local mode.

6. **Enter**

In parameter editing, the system will complete the input and insert a default unit for the parameter.

1.4.4 Front Panel Connectors

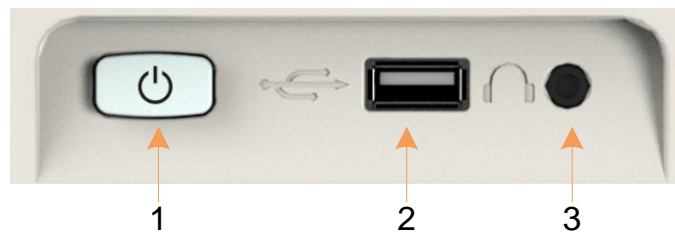

Figure 1-9 Front Panel Connectors (1)

1. Power Switch

Power on / Power down the instrument

2. USB Host

- ◆ The analyzer can serve as a “host” device to connect external USB devices. This interface is available for USB storage devices, the SIGLENT GPIB-USB adapter, wireless or wired mouse and keyboard.
- ◆ Read and write functions for an external USB storage device or store the contents currently displayed on the screen in the USB storage device in .png or .jpg or .bmp format.

3. Earphone Jack

The analyzer can demodulate AM and FM signals. Insert a 3.5 mm earphone into to the jack to acquire the audio output of the demodulated signal. You can turn on or off the earphone output and adjust the volume via **Demod** ->**Volume**.



CAUTION

Protect your hearing. Please turn the volume down to zero before using the earphone. Gradually turn the volume up to a comfortable level after putting in the earphone.

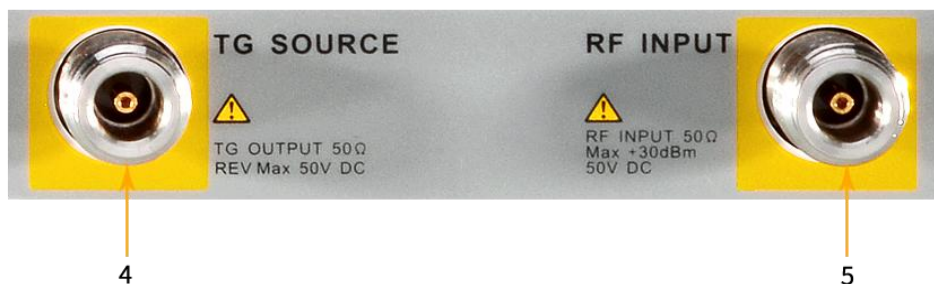

Figure 1-10 Front Panel Connectors (2)

4. TG SOURCE

The **TG SOURCE** can be connected to a device-under-test (DUT) through a cable with a male N-type male connector.



CAUTION

To avoid damaging to the tracking generator, the reverse DC voltage cannot exceed 50 V

5. RF INPUT

The **RF INPUT** can be connected to the DUT through a cable with a male N-type connector



CAUTION

To avoid damaging to the instrument, the RF input signal must meet the following: The DC voltage component and the maximum continuous power of the AC (RF) signal component cannot exceed 50 V and +30 dBm respectively.

1.5 Rear Panel

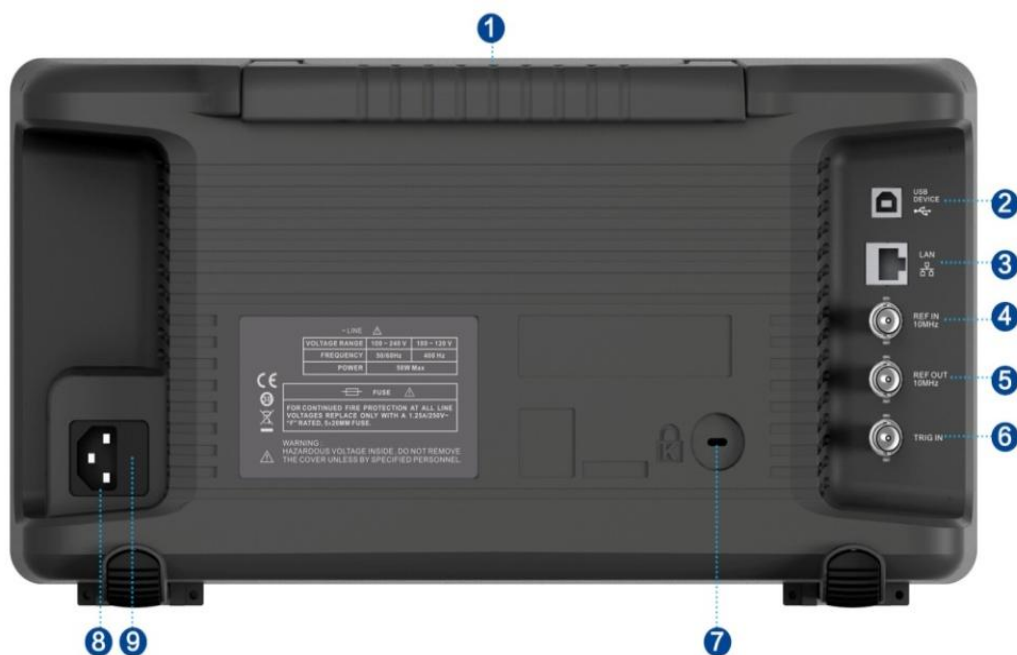

Figure 1-11 Rear Panel

1. Handle

Pull up the handle vertically for easy carrying of the instrument. When you do not need the handle, press it down.

2. USB Device Interface

The analyzer can serve as a “slave” device to connect external USB devices. Through this interface, a PC can be connected to control the analyzer.

3. LAN Interface

Through this interface, the analyzer can be connected to your local network (LAN) for remote control.

4. REF IN 10 MHz

The analyzer can use the internal or an external reference source.

- ◆ When a 10 MHz external clock signal is received through the **[10 MHz IN]** connector, this signal is used as the external reference source and “**Ext Ref**” is displayed in the status bar of the user interface. When the external reference is lost or not connected, the instrument switches to its internal reference source automatically and “**Ext Ref**” on the screen disappears.
- ◆ The **[10 MHz IN]** and **[10 MHz OUT]** connectors are usually used to build synchronization among multiple instruments.

5. REF OUT 10 MHz

The analyzer can use the internal or an external reference source.

- ◆ When an internal reference source is used, the **[10 MHz OUT]** connector can output a 10 MHz clock signal generated by the analyzer. This signal can be used to synchronize other instruments.
- ◆ The **[10 MHz OUT]** and **[10 MHz IN]** connectors are usually used to build synchronization among multiple instruments.

6. Trigger in

In external trigger mode, the analyzer will update the trace scan after the Trigger In connector receives an external trigger signal that meets the trigger input specifications.

7. Security Lock Hole

If needed, you can use a security lock(purchased separately) to lock the analyzer to a desired location.

8. AC Power Supply

The analyzer accepts 100-240V, 50/60 or 100-120VA 400Hz power supply. Please use the power cord provided as accessories to connect the instrument.

9. Fuse

Before power on, make sure the analyzer is protected by the proper input fuse.

1.6 User Interface

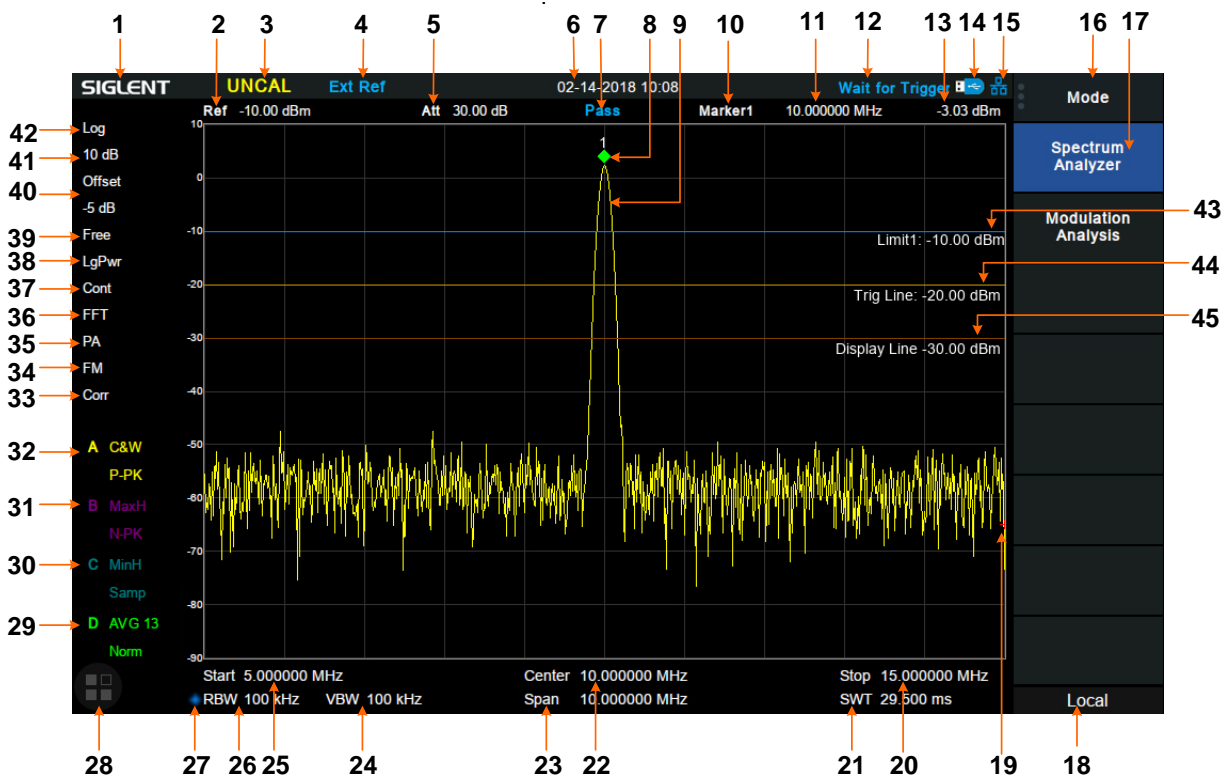

Figure 1-12 User Interface

Table 1-3 User Interface labels

NO.	Name	Description
1	SIGLENT	SIGLENT logo
2	Ref	Reference level
3	UNCAL	Instrument setup is out of measurement calibration.
4	EXT REF	Valid Ext 10 MHz reference clock detected indicator
5	Att	Attenuator Value
6	Day and time	System time
7	Pass/Fail status	Limit Pass/Fail status
8	Marker	Current active marker
9	Trace	Active trace
10	Marker instruction	current marker, touch to open a new marker
11	Marker x value	Unit: frequency, frequency delta or time
12	State indication	Auto Tune: Automatically sets the optimal parameters according to the characteristics of input signal Waiting for Trigger: waiting for trigger
13	Marker y value	Amplitude value or amplitude delta value
14	USB identification	Displayed when a USB flash drive is inserted

15	LAN identification	Displayed when a LAN cable is inserted	
16	Menu title	Function of the current menu.	
17	Menu items	Menu items of the current function. Front panel key menus may be different in different modes.	
18	Operation status	Local is local mode, Remote is remote mode, Upgrade means the instrument is upgrading	
19	Sweep progress	Indicates the currently scanned frequency position	
20	Stop frequency	Stop frequency value	
21	Sweep time	Time duration of a single sweep	
22	Center frequency	Center frequency value	
23	Span	Span value	
24	VBW	Video bandwidth	
25	Start frequency	The first frequency of a sweep	
26	RBW	Resolution bandwidth	
27	Manually instructions	When it appears, this parameter is not automatically coupled but manually configured	
28	Touch assistant	Click to open the commonly used functions for measurement, such as peak search.	
29	Trace A\B\C\D status	Trace type:	Detect type:
30		C&W: Clear Write	P-PK: Positive peak
31		MaxH: Max Hold	N-PK: Positive peak
32		MinH: Min Hold	Samp: Sample
		View: View	Norm: Normal
		AVG: Video average.	AVG: average
			Q-PK: Quasi-peak
33	Correction	When present, indicates that there is a user-configured amplitude correction table being mathematically applied to the displayed trace data	
34	AM or FM	AM or FM demodulation activated	
35	PA	Enable or disable the Preamplifier	
36	FFT	Sweep mode is FFT	
37	Single or Continue	Sweep mode single or continuous	
38	Average type	Log power\Power\Voltage power	
39	Trigger type	Free\Video\External trigger	
40	Ref offset	34: Ref offset identification; 35: Ref offset value	
41	Scale/Div	Scale value	
42	Scale type	Logarithm or linearity	
43	Limit line	Limit Pass/Fail level	
44	Trigger level	Video trigger level	
45	Display line	Reference display line	

1.7 Firmware Operation

1.7.1 Check System Information

Users can get the system information by press **System**->“**System Info**”, including

- ◆ Product Model, Serial and Host ID
- ◆ Software Version and hardware Version
- ◆ Option Information

1.7.2 Load Option

Refer to the procedures below to activate the options you have purchased.

1. Press **System**->“**System Info**”->“**Load Option**”
2. Enter the license key in the onscreen window. Press **Enter** to confirm your input and terminate the license key input. Or
3. Load the .lic file provided by pressing **File** ->“**Load**” from internal memory or USB stick.

The option will be enabled after rebooting.

1.7.3 Firmware Upgrade

Follow this procedure to update the instrument firmware:

1. Download the firmware package from an official SIGLENT website, <http://www.siglent.com/ens>,
 2. Extract and copy the .ADS file into the root directory of an USB stick.
 3. Plug the USB stick into the USB Host connector. Press **System**->“**System Info**”-> “**Firmware Update**”; find the .ADS file in USB stick.
 4. Press the “**Load**”, the analyzer will perform the update process automatically.
- ◆ The upgrade process will take several minutes. When the upgrade is completed, the machine will reboot.
 - ◆ Any interruption during the update process will result in update failure and system data loss. This is **not covered under the warranty** and the user will bear repair costs and shipping.
 - ◆ Do not remove the USB storage device until the update is finished.

1.8 Touch Operation

The analyzer has a 10.1 inch multi-touch screen and supports various gesture operations. Including:

- ◆ Press or click on the upper-right-corner of the screen to enter the main menu;
- ◆ Swipe up and down or left and right in the waveform area to change the X-axis center coordinate or Y-axis reference level;
- ◆ Perform two-points scaling in the waveform area to change the X-axis span;

- ◆ Click on a screen parameter or menu for parameter selection or editing;
- ◆ Open and drag the marker;
- ◆ Use auxiliary shortcuts to perform common operations.

You can turn the touch screen function on and off via **Display**->'Touch Settings'.

1.9 Remote Control

The analyzer supports communication with computers via USB, LAN, and GPIB-USB interfaces. By using these interfaces, in combination with programming languages and/or NI-VISA software, users can remotely control the analyzer based on a SCPI (Standard Commands for Programmable Instruments) compliant command set, LabView and IVI (Interchangeable Virtual Instrument), to interoperate with other programmable instruments.

You can also remote monitor and control the analyzer in Web Browser or Easy Spectrum.

For more details, refer to the 'Programming Guide' or contact your nearest SIGLENT office.

1.10 Using Built-in Help

The built-in help system provides information about every function key at the front panel and every menu soft key.

- ◆ Press **Help** and the embedded help would show up.
- ◆ Click on the items in the contents tree on the left to navigate to any topics interested.
- ◆ Click the green back or forward arrow to go back or forward to the contents just read.
- ◆ Click the close sign button in the top right corner or press the Esc front-panel key to quit the help system.



Figure 1-13 help information

1.11 Using the Security Lock

If needed, you can use the security lock (please buy it yourself) to lock the Spectrum Analyzer to a fixed location. The method is as follows, align the lock with the lock hole and plug it into the lock hole vertically, turn the key clockwise to lock the Spectrum Analyzer and then pull the key out.

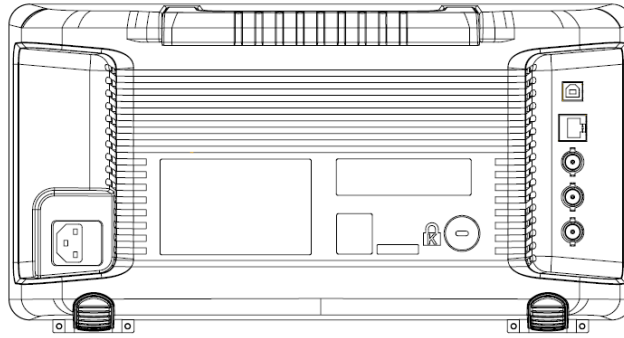

Figure 1-14 Security Lock

Chapter 2 Spectrum Analyzer

Press **Mode**, select 'Spectrum Analyzer' to enter spectrum analyzer mode.

The 'Spectrum Analyzer' mode is the default mode of the machine. In this mode, the **Mode** backlight does not light up; in other modes, the **Mode** backlight will light up.

This chapter introduces in detail the function keys and menu functions of the front panel in Spectrum Analyzer Mode.

Subjects in this chapter:

- ◆ Basic Settings
- ◆ Sweep and Functions
- ◆ Marker
- ◆ Measurement

2.1 Basic Settings

2.1.1 Frequency

Set the frequency-related parameters and functions of the analyzer. The sweep will restart every time the frequency parameters are modified.

The frequency range of a channel can be expressed by three parameters: Start Frequency, Center Frequency and Stop Frequency. If any of the parameters change, the others will be adjusted automatically in order to ensure the coupling relationship among them:

$$f_{\text{center}} = (f_{\text{start}} + f_{\text{stop}}) / 2, \text{ Where } f_{\text{span}} \text{ is the span.}$$

$$f_{\text{span}} = f_{\text{stop}} - f_{\text{start}}$$

2.1.1.1 Center Frequency

Set the center frequency of the current sweep. The center frequency and span values are displayed at the bottom of the grid respectively.

- ◆ Modifying the center frequency will modify both the start frequency and stop frequency when the span is constant (except when the start frequency or stop frequency reaches the boundary).
- ◆ In Zero Span, the start frequency, stop frequency and center frequency are always the same value.

Table 2-1 Center Frequency

Parameter	Parameter
Default	Full Span/2
Range	Zero Span, 0 Hz ~ Full Span Nonzero Span, 50 Hz ~ (Full Span -50Hz)
Unit	GHz, MHz, kHz, Hz
Knob Step	Span > 0, step = Span/200, min 1 Hz Span = 0, step = RBW/100, min 1 Hz
Direction Key Step	Freq Step
Related to	Start Freq, Stop Freq

2.1.1.2 Start Frequency

Set the start frequency of the current sweep. The start and stop frequencies are displayed at the bottom of the grid respectively.

- ◆ The span and center frequency vary with the start frequency when the Span does not reach the minimum. For more details, please refer to “Span”.
- ◆ In Zero Span, the start frequency, stop frequency and center frequency are always the same

value.

Table 2-2 Start Frequency

Parameter	Explanation
Default	0 Hz
Range	Zero Span, 0 Hz ~ Full Span Nonzero Span, 0 Hz ~ (Full Span-100Hz)
Unit	GHz, MHz, kHz, Hz
Knob Step	Span > 0, step = Span/200, min 1 Hz Span = 0, step = RBW/100, min 1 Hz
Direction Key Step	Freq Step
Related to	Center Freq, Span

2.1.1.3 Stop Frequency

Set the stop frequency of the current sweep. The start and stop frequencies are displayed at the lower right sides of the grid respectively.

- ◆ The span and center frequency vary with the stop frequency. The change of the span will affect other system parameters. For more details, please refer to “**Span**”.
- ◆ In Zero Span, the start frequency, stop frequency and center frequency are always the same value.

Table 2-3 Stop Frequency

Parameter	Explanation
Default	Full Span
Range	Zero Span: 0 Hz ~ Full Span Nonzero Span: 100 Hz ~ Full Span
Unit	GHz, MHz, kHz, Hz
Knob Step	Span > 0, step = Span/200, min 1 Hz Span = 0, step = RBW/100, min 1 Hz
Direction Key Step	Freq Step
Related to	Center Freq, Span

2.1.1.4 Freq Offset

Set the frequency offset value to illustrate the frequency conversion between the measured device and the input of the spectrum analyzer.

- ◆ This parameter does not affect any hardware settings of the spectrum analyzer, but only changes the display values of center frequency, start frequency and stop frequency.
- ◆ To eliminate the frequency offset value, the frequency offset value can be set to 0 Hz.

Table 2-4 Freq Offset

Parameter	Explanation
Default	0 Hz
Range	-100GHz ~ 100GHz
Unit	GHz, MHz, kHz, Hz
Knob Step	Span > 0, Step = Span/200, min 1 Hz Span = 0, Step = RBW/100, min 1 Hz
Direction Key Step	Freq Step
Related to	Center Freq, Start Freq, Stop Freq

2.1.1.5 Freq Step

Setting the value of Freq Step will change the direction key step of center frequency, start frequency, stop frequency and frequency offset.

- ◆ At a fixed step change the value of the center frequency can reach the purpose of switching measurement channels rapidly and continuously.
- ◆ There are two kinds of frequency step modes: **Auto** and **Manual**. In Auto mode, the Freq step is 1/10 of the span in Non-zero span or equals the RBW while in Zero Span. In Manual mode, you can set the step using the numeric keys.

Table 2-5 Freq Step

Parameter	Explanation
Default	Full Span/10
Range	1Hz ~ Full Span
Unit	GHz, MHz, kHz, Hz
Knob Step	Span > 0, Step = Span/200, min 1 Hz Span = 0, Step = RBW/100, min 1 Hz
Direction Key Step	In 1-2-5 sequence
Related to	RBW, Span and related parameters

2.1.1.6 Signal Track

Turn on or off the signal tracking function. It is used to track the signal whose frequency is unstable and the instantaneous change of the amplitude is less than 3 dB. By marking cursor 1 on the measured signal, the change of the measured signal can be tracked and measured all the time.

The signal tracking process is shown in the following figure:

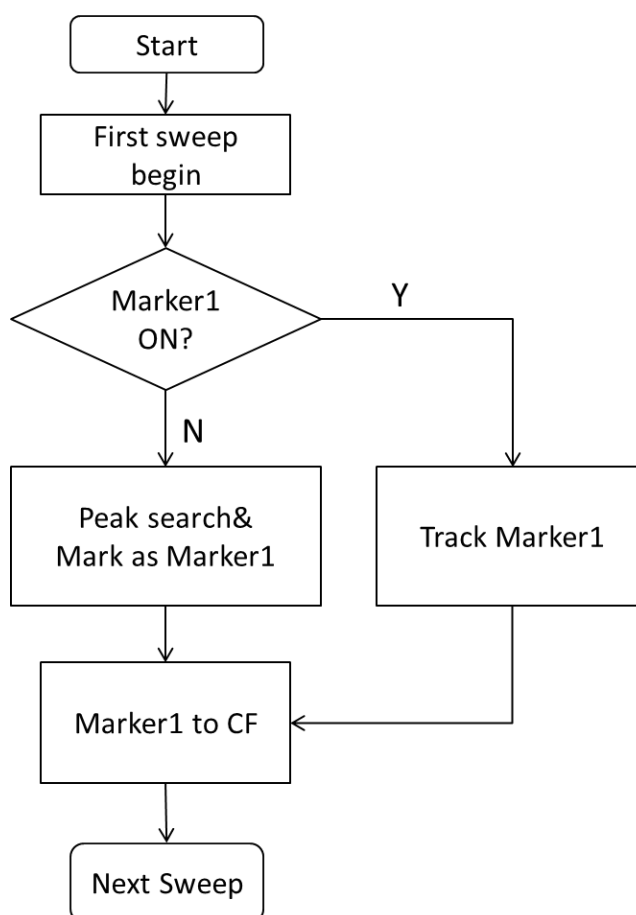

Figure 2-1 Signal Tracking Flow

- ◆ When Marker1 is on, turn on signal tracking, a point whose amplitude does not change more than 3 dB near Marker1 will be searched and marked, and the frequency at that point will be set to center frequency.
- ◆ When Marker1 is off, turn on signal tracking, Marker1 will be activated, and a peak search will be performed, and then the peak frequency will be set to center frequency.
- ◆ Signal tracking function is only available in sweep analysis. Signal tracking function is turned off in following cases:
 - ✓ Zero Span mode
 - ✓ Tracking Generator(TG) open
 - ✓ Traces are not updated, including single sweep mode or View mode.
 - ✓ Cont Peak function turned on
 - ✓ Other non-SA measurement modes

2.1.1.7 Peak -> CF

Executes a peak search and sets the center frequency (CF) of the display to the frequency of the current peak. The function is invalid in Zero Span.

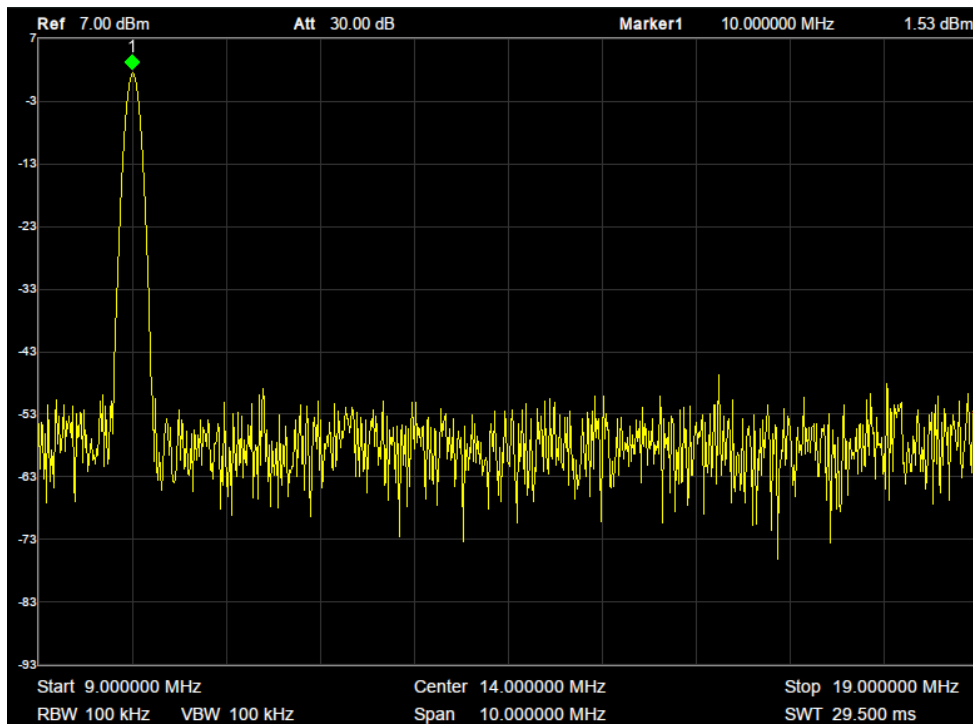

Figure 2-2 before Peak -> CF

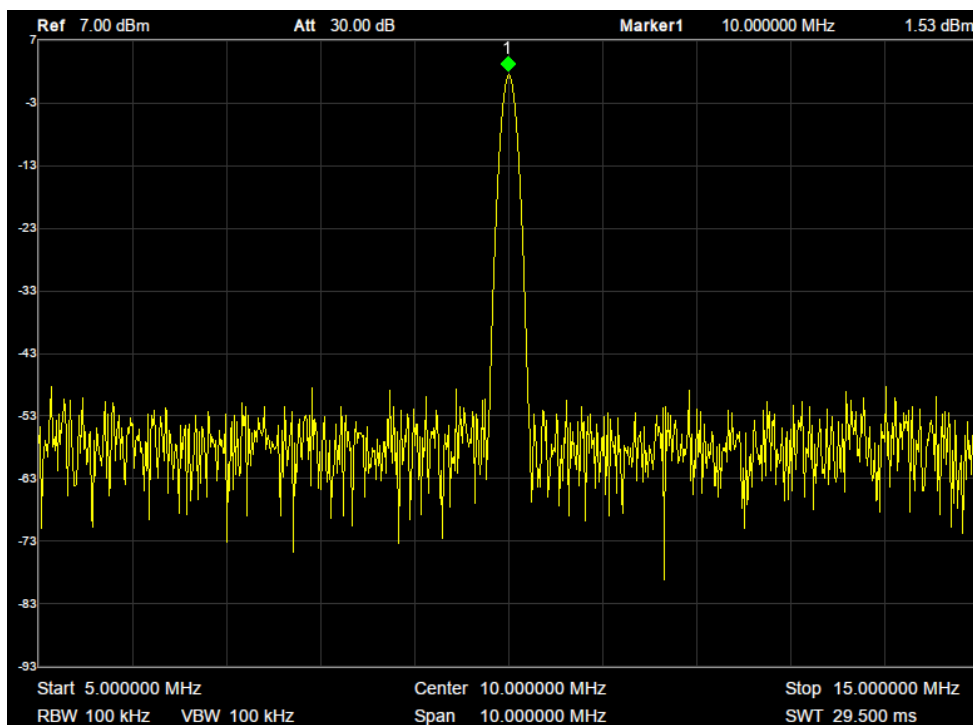

Figure 2-3 after Peak -> CF

2.1.1.8 CF -> Step

Set the current center frequency as the Freq Step. At this point, the Freq Step will switch to “**Manual**” mode automatically. This function is usually used in channel switching. For example, in harmonic measurement, firstly locate the signal at the center frequency (CF) of the display, and then execute

CF->Step. Next you can press the upward direction key continuously to measure each order of harmonic in sequence.

2.1.2 Span

Set the span of the analyzer. Any change of this parameter will affect the frequency parameters and restart the sweep.

2.1.2.1 Span

Set the frequency range of the current sweep. The center frequency and span are displayed at the bottom of the grid respectively.

- ◆ The start and stop frequency vary with the span when the center frequency is constant.
- ◆ In non-zero span mode, the span can be set down to 100 Hz and up to the full span described in Specifications. When the span is set to the maximum, the analyzer enters full span mode.
- ◆ Modifying the span in non-zero span mode may cause an automatic change in both Freq Step and RBW if they are in Auto mode. Besides, the change of RBW may influence VBW (in Auto VBW mode).
- ◆ Variation in the span, RBW or VBW would cause a change in the sweep time.

Table 2-6 Span

Parameter	Explanation
Default	Full Span
Range	0 Hz ~ Full Span
Unit	GHz, MHz, kHz, Hz
Knob Step	Span/200, min 1 Hz
Direction Key Step	In 1-2-5 sequence
Related to	Start Freq, Stop Freq, Freq Step, RBW, Sweep time

Note: 0 Hz is available only in zero span.

2.1.2.2 Full Span

Set the span of the analyzer to the maximum available frequency span.

2.1.2.3 Zero Span

Set the span of the analyzer to 0Hz. Both the start and stop frequencies will equal to center frequency and the horizontal axis will denote time. The analyzer measures the time domain characteristics of the amplitude of the corresponding frequency point of the input signal.

- ◆ The following functions are invalid in Zero span:
 - ✓ **Frequency**: Peak->CF and Signal Track;
 - ✓ **SPAN**: Zoom In and Zoom Out;
 - ✓ **Sweep**: Sweep Mode;

- ✓ **Marker->**: M->CF, M->CF step, M->Start Freq, M->Stop Freq, ΔM->Span and ΔM->CF;
- ✓ **Marker Fn**: Read Out(default option: ΔTime);

2.1.2.4 Zoom In

Set the span to half of its current value. At this point, the signal on the screen will be amplified to observe signal details.

2.1.2.5 Zoom Out

Set the span to twice the current value. At this point, the signal on the screen will be reduced to gain more information about the nearby spectrum.

2.1.2.6 Last Span

Set the span to the previous span setting.

2.1.2.7 X-Scale

Set the scale type of X-axis to Linear (Lin) or Logarithmic (Log) scale.

In Log scale type, the frequency scale of X-axis is displayed in the logarithmic form, and Meas function is invalid.

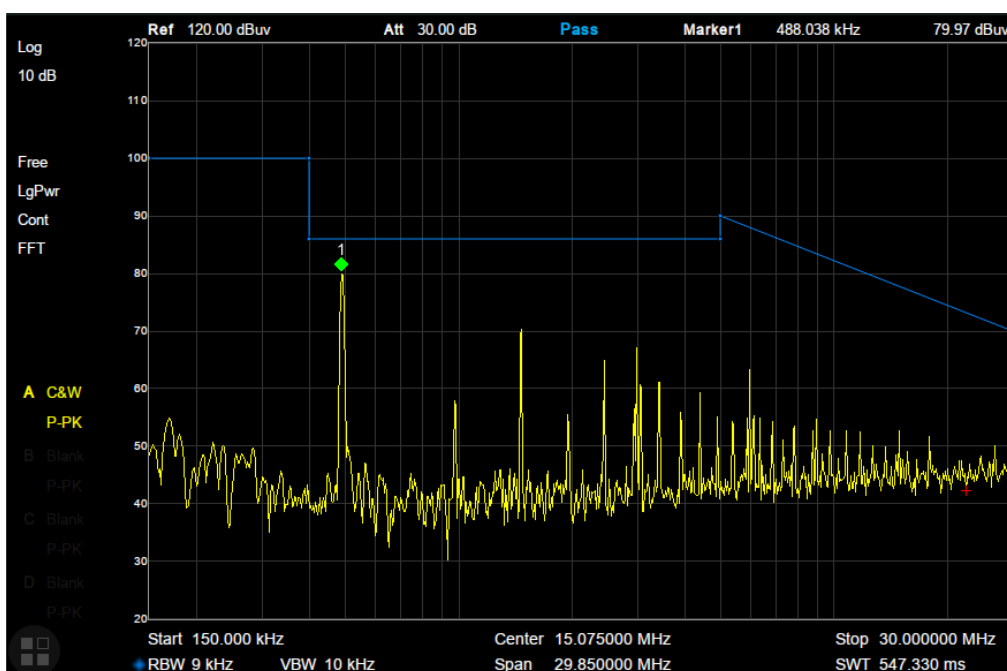

Figure 2-4 Logarithmic X Scale

2.1.3 Amplitude

Set the amplitude parameters of the analyzer. Through modifying these parameters, signals under measurement can be displayed in a proper mode for easier observation and minimum error. Any

change of Ref Level, Attenuator Value, Preamp mode and Ref Offset will restart sweep.

2.1.3.1 Ref Level

Set the maximum power or voltage that can be currently displayed in the trace window. The value is displayed at the upper left corner of the screen grid.

The maximum reference (Ref) level available is affected by the maximum mixing level; input attenuation is adjusted under a constant maximum mixing level in order to fulfill the following condition:

$$Ref \leq ATT - PA - 20dBm, \text{ where } ATT = \text{Attenuation value}, PA = \text{Preamplifier value}$$

Table 2-7 Ref Level

Parameter	Explanation
Default	0 dBm
Range	-200 dBm ~ 20 dBm
Unit	dBm, dBmV, dBuV, dBuA, V, W
Knob Step	In Log scale mode, step = Scale/10 In Lin scale mode, step = 0.1 dBm
Direction Key Step	In Log scale mode, step = Scale In Lin scale mode, step = 1 dBm
Related to	Attenuator, Preamp, Ref Offset

Note: the maximum reference level of different machine models may be different, please refer to the data manual specifically.

2.1.3.2 Attenuator

Set the value for the internal attenuator of the RF input. So that the large signal can be low distortion and the small signal can pass through the mixer with low noise.

$$Ref \leq ATT - PA - 20dBm, \text{ where } ATT = \text{Attenuation value}, PA = \text{Preamplifier value}$$

Input attenuation can be set up to auto or manual mode.

- ◆ Auto mode: the attenuation value is automatically adjusted according to the state of preamplifier and the current reference level.
- ◆ The maximum input attenuation can be set to 31 dB. When the set parameters do not meet the above formula, you can adjust the reference level.

Table 2-8 Attenuator

Parameter	Explanation
Default	20 dB
Range	0 ~ 31 dB
Unit	dB
Knob Step	1 dB
Direction Key Step	5 dB
Related to	Preamp, Ref level

Note: the maximum attenuator value of different machine models may be different, please refer to the data manual specifically.

2.1.3.3 RF Preamp

Control the state of the internal preamplifier (PA) located in the RF input signal path. When the signal-under-measurement is small, turning on the preamplifier can reduce the displayed noise level and aid distinguishing small signals from the noise.

The corresponding icon “**PA**” will appear at the left side of the screen when the preamplifier is turned on.

2.1.3.4 Units

Set the unit of the Y-axis to dBm, dBmV, dBuV, dBuA, Volts (RMS) or Watts. Default is dBm.

The conversion relationships between units are as follows.

$$\text{dBm} = 10\lg\left(\frac{\text{Volts}^2}{R} \times \frac{1}{1\text{mW}}\right)$$

$$\text{dB}\mu\text{V} = 20\lg\left(\frac{\text{Volts}}{1\mu\text{V}}\right)$$

$$\text{dBmV} = 20\lg\left(\frac{\text{Volts}}{1\text{mV}}\right)$$

$$\text{Watts} = \frac{\text{Volts}^2}{R}$$

Where, R denotes the reference impedance. The default value is 50Ω and can be adjusted by pressing “**Correction -> RF input**”. The “75 Ω” impedance is just a numeric value, not a real impedance. Setting the RF input to 75 Ω will not change the actual input impedance. A 75 Ω feed-through adapter is required to match 75 Ω circuits to the 50 Ω input of the analyzer.

2.1.3.5 Scale

Set the logarithmic units per vertical grid division on the display. This function is only available when the scale type is set to “**log**”.

- ◆ By changing the scale, the displayed amplitude range is adjusted.
- ◆ The Minimum range: Reference level –10 × current scale value.
- ◆ The Maximum range: The reference level.

Table 2-9 Scale/Div

Parameter	Explanation
Default	10 dB
Range	0.1 dB ~ 20 dB
Unit	dB
Knob Step	Scale \geq 1, 1 dB, Scale $<$ 1, 0.1dB
Direction Key Step	1-2-5 sequence
Related to	Scale Type

2.1.3.6 Scale Type

Set the scale type of the Y-axis to Lin or Log. The default is Log.

- ◆ In Lin mode, the vertical Scale value cannot be changed. The Display area is set for reference level of 0%.
- ◆ In Log scale type, the Y-axis denotes the logarithmic coordinate. The value shown at the top of the grid is the reference level and each grid represents the scale value. The unit of Y-axis will automatically switch to the default unit (dBm) in Log scale type when the scale type is changed from Lin to Log.
- ◆ In Lin scale type, the Y-axis denotes the liner coordinate; the values shown at the top of the grid and the bottom of the grid are the reference level and 0 V. The scale setting function is invalid. The unit of Y-axis will automatically switch to the default unit (Volts) in Lin scale type when the scale type is charged from Log to Lin.

2.1.3.7 Ref Offset

Assign an offset to the reference level to compensate for gains or losses generated between the device under measurement and the analyzer.

The change of this value changes both the reference level readout and the amplitude readout of the marker; but does not impact the position of traces on the screen.

Table 2-10 Ref Offset

Parameter	Explanation
Default	0 dB
Range	-100 dB ~ 100 dB
Unit	dB
Knob Step	Not support
Direction Key Step	Not support
Related to	Ref Level

2.1.3.8 Correction

Correct the displayed amplitude to compensate for gains or losses from external devices such as antennas and cables. When using this function, you can view the correction data table and save or load the current correction data. When amplitude correction is enabled, both the trace and related measurement results will be mathematically corrected. Positive correction values are added to the measured values. Negative (-) correction values are subtracted from the measured values.

1. RF Input

Set the input impedance for numeric voltage-to-power conversions. To measure a 75 Ω device, you should use a 75 Ω to 50 Ω adapters to connect the analyzer with the system-under-test and then set the input impedance to 75 Ω .

2. Apply Correction

Enable or disable amplitude corrections. Default is Off. The analyzer provides four correction factors that can be created and edited separately, but they can be applied independently in any combination.

3. Edit Correction factors

Table 2-11 Edit Correction table

Function	Explanation
Correction	Select the correction factor on or off.
Add Point	Add a point into correction table.
Point Num	Select a point to edit by point num.
Frequency	Edit the frequency value for the current selected point.
Amplitude	Edit the amplitude value for the current selected point.
Del Point	Delete the selected correction point.
Del All	Clear all data of the correction table.
Save/Load	Save or load correction data. You can save the current correction data into or load correction data from a specified file.

2.1.4 Auto Tune

The analyzer will search for signals automatically throughout the full frequency range and adjust the frequency and amplitude settings for optimum display of the strongest signal.

- ◆ In the process of auto search, The “**Auto Tune**” is shown in the status bar on the screen until the search is finished.
- ◆ Some parameters such as the reference level, scale, input attenuation and maximum mixing level may be changed during the auto search.

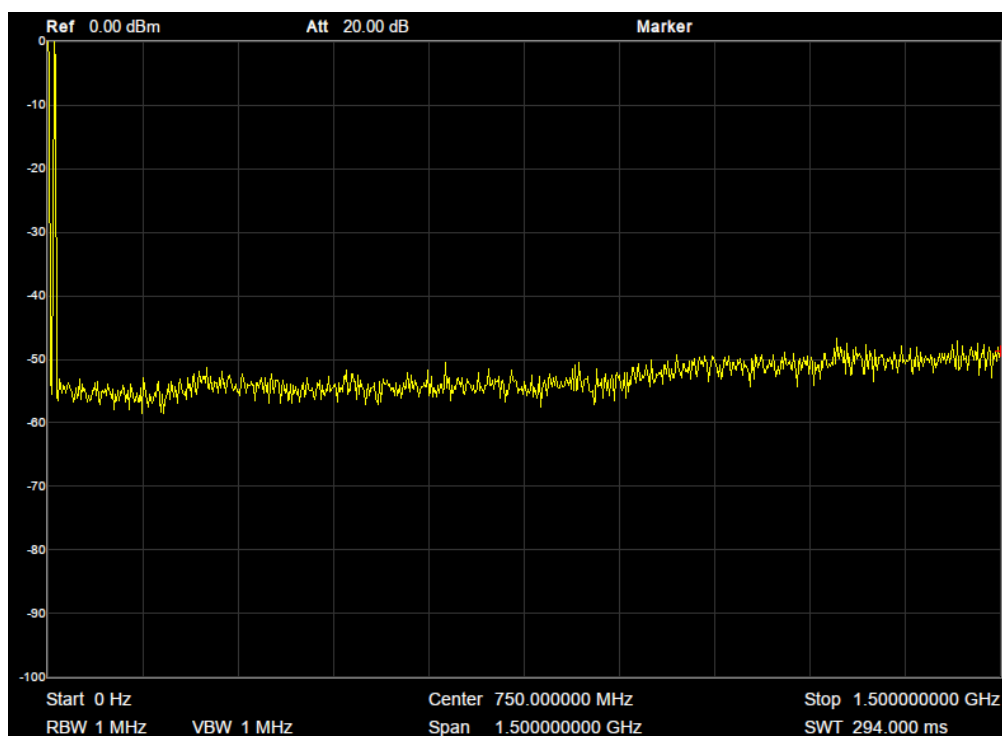

Figure 2-5 before Auto Tune

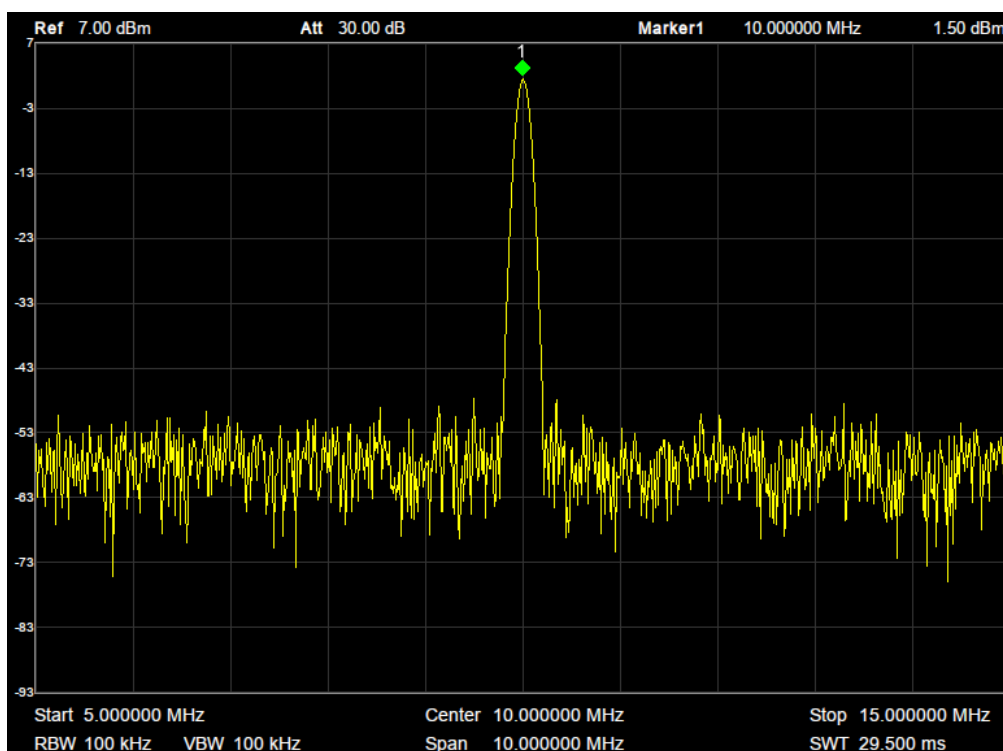

Figure 2-6 after Auto Tune

2.2 Sweep and Functions

2.2.1 BW

The bandwidth menu contains the RBW (Resolution Bandwidth), VBW (Video Bandwidth), average type and filter type. Filter type includes the EMI filter type that enables EMI measurement controls.

2.2.1.1 Resolution Bandwidth

Set the resolution bandwidth in order to distinguish between signals which have frequency components that are near one another.

- ◆ Reducing the RBW will increase the frequency resolution, but will also increase the sweep time dramatically (Sweep Time is affected by a combination of RBW and VBW when the analyzer is in Auto mode).
- ◆ Generally, the frequency resolution ability is affected by RBW, RBW Filter shape factor, LO Phase noise, and LO Residual FM.
- ◆ RBW varies with the span (non-zero span) in Auto RBW mode.
- ◆ Under EMI filter, RBW can only be set to 200 Hz, 9 kHz, 120 kHz and 1 MHz with a 6dB shape factor.

Table 2-12 RBW

Parameter	Explanation
Default	1 MHz
Range	1 Hz ~ 1 MHz
Unit	MHz, kHz, Hz
Knob Step	in 1, 3, 10 sequence
Direction Key Step	in 1, 3, 10 sequence
Relation	Span, VBW, V/R Ratio, Sweep Time

Notes: RBW of above table is in Gauss filter type.

2.2.1.2 Video Bandwidth

Set the video bandwidth in order to filter out the noise outside the video band.

- ◆ Reducing the VBW will smooth the trace and helps to highlight small signals from noise, but it will also increase the sweep time (Sweep Time is affected by a combination of RBW and VBW when it is in Auto mode).
- ◆ VBW varies with RBW when it is in Auto mode. While in Manual mode, VBW is not affected by RBW.

Table 2-13 VBW

Parameter	Explanation
Default	1 MHz
Range	1 Hz ~ 1 MHz
Unit	MHz, kHz, Hz
Knob Step	in 1, 3 sequence
Direction Key Step	in 1, 3 sequence
Relation	RBW, V/R Ratio, Sweep Time

2.2.1.3 V/R Ratio

Set the ratio of VBW to RBW. This value is different while measuring different kinds of signals:

- ◆ Sine/Continuous Wave (CW) signals: Use 1 to 3 (for faster sweeps)
- ◆ Pulsed/transient signals: Use 10 (to reduce the influence on the amplitude of transient signals)
- ◆ Noise signals: Generally use 0.1 (to obtain the average of noises)

Table 2-14 V/R Ratio

Parameter	Explanation
Default	1
Range	0.001 ~ 1000
Unit	N/A
Knob Step	in 1, 3 sequence
Direction Key Step	in 1, 3 sequence
Relation	RBW, VBW

2.2.1.4 Average Type

Choose one of the following averaging types: log power (video), power (RMS), or voltage averaging. When trace average is on, the average type is shown on the left side of the display.

1. Log Power

Select the logarithmic (decibel) scale for all filtering and averaging processes. This scale is "Video" because it is the most common display and analysis scale for the video signal within analyzer. This scale is excellent for finding Sine/CW signals near noise.

2. Power Average

In this average type, all filtering and averaging processes work on the power (the square of the magnitude) of the signal, instead of its log or envelope voltage. This scale is best for real-time power measurement of complex signals.

3. Voltage Average

In this Average type, all filtering and averaging processes work on the voltage of the envelope of the

signal. This scale is suitable for observing rise and fall behavior of AM or pulse-modulated signals such as radar and TDMA transmitters.

2.2.1.5 Filter

Set the RBW filter type. The analyzer supports two kinds of RBW filters: “**Gauss**” (-3 dB bandwidth) and “**EMI**” (-6 dB bandwidth).

When “**EMI**” is selected, resolution bandwidth can only be 200 Hz, 9 kHz, 120 kHz and 1 MHz
 “**Quasi-Peak**” detector is available only when “**EMI**” filter is turned on.

2.2.2 Trace

The sweep signal is displayed as a trace on the screen.

2.2.2.1 Select Trace

The analyzer allows for up to four traces to be displayed at the same time. Each trace has its own color (Trace A - Yellow, Trace B - Purple, Trace C - Light blue and Trace D - Green). All traces can be set parameter independently. As a default, analyzer will choose Trace A and set the type of the trace as Clear Write.

2.2.2.2 Trace Type

Set the type of the current trace or disable it. The system calculates the sampled data using a specific operation method according to the trace type selected and displays the result. Trace types include Clear Write, Max Hold, Min Hold, View, Average and Blank. The corresponding icon of the trace type will be displayed in the status bar at the left of the screen, as shown in the figure below.

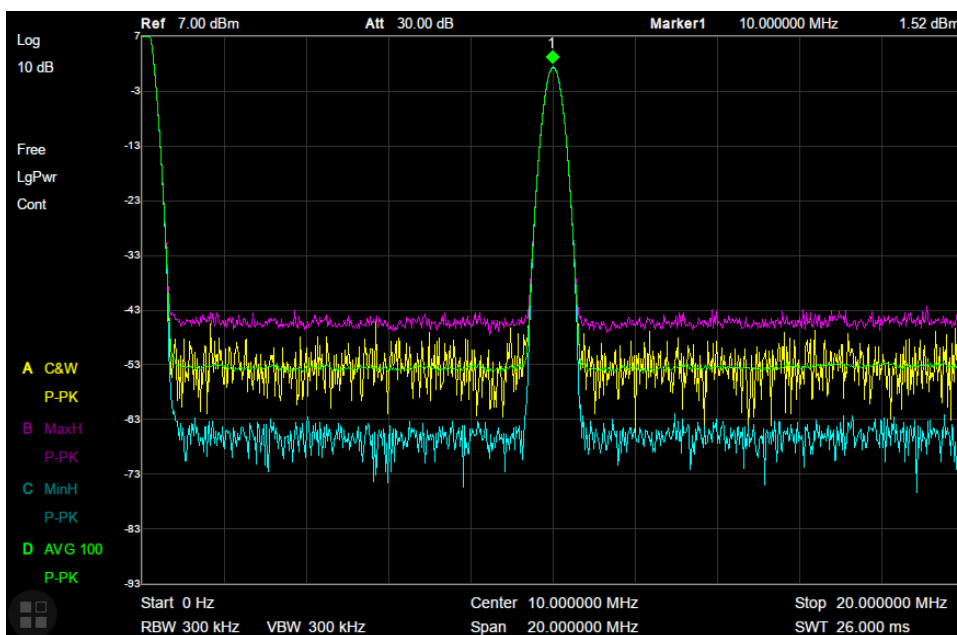

Figure 2-7 Trace Type

1. Clear Write

Erases any data previously stored in the selected trace, and display the data sampled in real-time of each point on the trace.

2. Max Hold

Retain the maximum level for each point of the selected trace. Update the data if a new maximum level is detected in successive sweeps. Max Hold is very effective when measuring events that may take successive scans to measure accurately. Some common applications include FM Deviation, AM NRSC, and frequency hopping or drift.

3. Min Hold

Display the minimum value from multiple sweeps for each point of the trace and update the data if a new minimum is generated in successive sweeps.

4. View

Freezes and holds the amplitude data of the selected trace. The trace data is not updated as the analyzer sweeps.

5. Blank

Disable the trace display and all measurements of this trace.

6. Average

Set the averages times of the selected trace.

More averages can reduce the noise and the influence of other random signals; thus highlighting the stable signal characteristics. The larger the averages times is, the smoother the trace will be. Enabling averaging will take more time to collect the full spectral information because the analyzer needs to sweep the set average count. The displayed data is averaged in a first-in-first-out fashion.

Table 2-15 Average Times

Parameter	Explanation
Default	100
Range	1 ~ 999
Unit	N/A
Knob Step	1
Direction Key Step	5

2.2.2.3 Math

Set the computational method of the math trace.

1. Output Z

The Math result is denoted by the Z variable and can be displayed by trace A, B, C, or D.

2. Input X, Y

Input X, Y can be applied to trace A, B, C, or D.

3. Calculation Type

The analyzer provides the calculation types as shown below:

- ◆ **Power Diff:** $X-Y+Offset \rightarrow Z$
- ◆ **Power Sum:** $X+Y+Offset \rightarrow Z$
- ◆ **Log Offset:** $X+Offset \rightarrow Z$
- ◆ **Log Diff:** $X-Y-Ref \rightarrow Z$

4. Offset value

Table 2-16 Offset value

Parameter	Explanation
Default	0 dB
Range	-100 dB ~ 100 dB
Unit	dB
Knob Step	1 dB
Direction Key Step	1 dB

2.2.3 Detect

The analyzer displays the sweep signal on the screen in the form of a trace. For each trace point, the analyzer always captures all the data within a specific time interval and processes (Peak, Average, etc.) the data using the detector currently selected, then it displays the processed data (a single data point) on the screen.

Select an appropriate detector type according to the actual application in order to ensure the accuracy of the measurement.

The available types are **Pos Peak**, **Neg Peak**, **Sample**, **Normal**, **Average** and **Quasi Peak**. The default is **Pos peak**.

1. Positive Peak

For each trace point, Positive Peak detector displays the maximum value of data sampled within the corresponding time interval.

2. Negative Peak

For each trace point, Negative Peak detector displays the minimum value of data sampled within the corresponding time interval.

3. Sample

For each trace point, Sample detector displays the transient level corresponding to the central time

point of the corresponding time interval. This detector type is applicable to noise or noise-like signal.

4. Normal

Normal detector (also called ROSENFELL Detector) displays the maximum value and the minimum value of the sample data segment in turn: Odd-numbered data points display the maximum value and even-numbered data points display the minimum value. In this way, the amplitude variation range of the signal is clearly shown.

5. Average

For each trace point, Average detector displays the average value of data sampled within the corresponding time interval.

6. Quasi-Peak

Quasi-Peak (QP) detector, which is a weighted form of peak detector, is used for EMC pulse testing. The QP detector is designed to follow CISPR-16 response specifications. For a single frequency point, the detector detects the peaks within the QP dwell time.

The peaks detected are weighted using a digital model that follows a defined response curve as well as the time constant specified in the CISPR 16 standards. The measurement time for QP is far longer than Peak Detector.

2.2.4 Sweep

Sets parameters about the Sweep functions, including sweep time, sweep times, sweep mode, etc.

2.2.4.1 Sweep Time

Sets the time needed for the analyzer to finish a sweep within the span range. The sweep time can be set in “Auto” or “Manual” mode and the default is “Auto”.

- ◆ In non-zero span, the analyzer selects the shortest sweep time on the basis of the current RBW and VBW settings if Auto is selected.
- ◆ Decreasing the sweep time will decrease measurement time. However, an error may be caused if the specified sweep time is less than the minimum sweep time in Auto coupling; at this point, “UNCAL” is shown in the status bar on the screen. Measurements taken with “UNCAL” showing may not meet the specifications of the instrument and can have significant error.

Table 2-17 Sweep Time

Parameter	Explanation
Default	N/A
Range	900 us ~ 1.5 ks (Quasi Peak: 900us ~ 15ks)
Unit	ks, s, ms, us
Knob Step	Sweep time/100, min =1 ms
Direction Key Step	in 1, 3 sequence

2.2.4.2 Sweep Rule

The analyzer provides two sweep time rules to meet the different sweep time requirements:

- ◆ **Speed:** Activates the default fast sweep time rule.
 - ◆ **Accuracy:** Activates the normal sweep time rule to ensure increased measurement accuracy.
- The Speed sweep time rule provides a fast measurement function that decreases the sweep time. While the Accuracy Sweep rule will increase the measurement accuracy.

2.2.4.3 Sweep

Set the sweep mode in single or continuous, the default is continuous. The corresponding icon of the sweep will be displayed in the status bar at the left of the screen.

1. Single

Set the sweep mode to “**Single**”. The number on the parameter icon denotes the current sweep times.

2. Numbers

Set the sweeps times for a single sweep. In single sweep mode, the system executes the specified sweeps times and the number shown on the icon in the status bar at the left of the screen varies with the process of the sweep.

3. Continue

Set the sweep mode to “Continue”. The character Cont on the parameter icon denotes the analyzer is sweeping continuously.

- ◆ If the instrument is in single sweep mode and no measurement function is enabled, press this key and the system will enter continuous sweep mode and sweep continuously if the trigger conditions are satisfied.
- ◆ If the instrument is in single sweep mode and a measurement function is on, press this key and the system will enter continuous sweep mode and measure continuously if the trigger conditions are satisfied.
- ◆ In continuous sweep mode, the system will send a trigger initialization signal automatically and enter the trigger condition judgment directly after each sweep.

Table 2-18 Sweep Times

Parameter	Explanation
Default	1
Range	1 ~ 99999
Unit	N/A
Knob Step	1
Direction Key Step	1

2.2.4.4 Sweep Mode

Sweep mode includes auto mode, sweep mode and FFT mode.

1. Auto

When the sweep mode is auto, the analyzer selects the sweep mode automatically between Sweep and FFT Mode in the shortest time.

2. Sweep

True swept operation including point-by-point scanning. The Sweep mode is available when the RBW is in 30 Hz – 1 MHz.

3. FFT

The FFT mode is only available when RBW is in 1 Hz - 10 kHz.

When the tracking generator (TG) is on, the sweep mode is forced to Sweep.

2.2.4.5 QPD Dwell Time

Dwell time is the measurement time at a single frequency. QP detector gets its weighted envelope response during this dwell time. The longer dwell time is, the more sufficiently the QP detector responses to a single frequency, and the more accurate the QP detector envelope is.

Table 2-19 QPD Dwell Times

Parameter	Explanation
Default	50 ms
Range	0 s ~ 10 s
Unit	ks, s, ms, us
Knob Step	1 ms
Direction Key Step	1 ms

2.2.5 Trigger

The trigger type can be Free Run, Video or External.

2.2.5.1 Free Run

The trigger conditions are satisfied at any time and the analyzer generates trigger signals continuously.

2.2.5.2 Video Trigger

A trigger signal will be generated when the system detects a video signal of which the voltage exceeds the specified video trigger level.

Set the trigger level with the video trigger menu entry. At this point, the trigger level line (Trig Line) and

value are displayed on the screen.

Table 2-20 Trigger Setup

Parameter	Explanation
Default	0 dBm
Range	-300 dBm ~ 50 dBm
Unit	dBm
Knob Step	1 dBm
Direction Key Step	10 dBm

2.2.5.3 External

In this mode, an external signal (TTL signal) is input from the [TRIGGER IN] connector at the rear panel and trigger signals are generated when this signal fulfills the specified trigger edge condition.

Set the trigger edge in external trigger to the rising (Pos) or falling (Neg) edge of the pulse.

2.2.6 Limit

The analyzer supports Pass/Fail test function. In this function, the measured curve will be compared with the pre-edited curve. If the related rules are met, the result is “Pass”, else the result is “Fail”.

2.2.6.1 Limit1

Enable or disable limit1.

2.2.6.2 Limit1 Edit

Edit the properties of limit1.

Table 2-21 Limit1 Edit Menu

Function	Explanation
Type	Select upper or lower limit type. The default value is Upper.
Mode	Select limit line or limit point. The default value is Line. Set the number of the point to be edited if you selected the point type, and the range is 1 ~ 100.
Add point	Add a new point for editing.
X-axis	Edit the X-axis value (frequency or time) of the current point.
Amplitude	Edit the amplitude of the current point or line.
Del Point	Delete the point whose number is selected in Mode.
Del All	Delete all the points.
Save/Load	Save or load the limit file.

2.2.6.3 Limit2

Enable or disable limit2.

2.2.6.4 Limit2 Edit

Edit the properties of limit2.

Table 2-22 Limit2 Edit Menu

Function	Explanation
Type	Select upper or lower limit type. The default value is Lower.
Mode	Select limit line or limit point. The default value is Line. Set the number of the point to be edited if you selected the point type, and the range is 1 ~ 100.
Add point	Add a new point for editing.
X-axis	Edit the X-axis value (frequency or time) of the current point.
Amplitude	Edit the amplitude of the current point or line.
Del Point	Delete the point whose number is selected in Mode.
Del All	Delete all points.
Save/Load	Save or load the limit file.

2.2.6.5 Test

Enable or disable the limit test function.

2.2.6.6 Setup

1. Fail to stop

Turn on or off the Fail to stop function. If the function is on, the analyzer will stop sweep and retain the test result when the test result is "Fail".

2. Buzzer

Turn on or off the buzzer. When the buzzer is on, it beeps when the test result is "Fail".

3. X Axis

Set the X-axis to frequency or time domain. The default value is Freq.

Note that all the points of the current limit line will be deleted if the X-axis unit changes.

2.2.7 TG (Tracking Generator)

Set the parameters related to the tracking generator (TG) and normalize.

2.2.7.1 TG

The tracking generator is a signal source with an adjustable frequency and amplitude. When the TG is enabled, a signal with the same frequency of the current sweep signal will be output from the **[TG SOURCE]** connector at the front panel. The power of the signal could be set through the menu. The TG output frequency follows the analyzer sweep frequency. For example, if the sweep is set to scan from 1 MHz to 10 MHz, the TG output frequency will change from 1 MHz to 10 MHz in coordinated steps with the sweep. In Zero Span mode, the TG frequency will match the center frequency of the analyzer.

2.2.7.2 TG Level

Set the output power of the signal of the tracking generator.

Table 2-23 TG Level

Parameter	Explanation
Default	-20 dBm
Range	-20 dBm ~ 0 dBm
Unit	dBm
Knob Step	1 dBm
Direction Key Step	10 dBm

2.2.7.3 TG Level Offset

Assigns a certain offset to the output power of the TG when gains or losses occur between the TG output and external device in order to display the actual power value.

- ◆ This parameter only changes the readout of the TG output power, rather than the actual value.
- ◆ The offset could be either a positive (gain in the external output) or a negative (loss in the external output).

Table 2-24 TG Level Offset

Parameter	Explanation
Default	0 dB
Range	-200 dB ~ 200 dB
Unit	dB
Knob Step	1 dB
Direction Key Step	10 dB

2.2.7.4 Normalize

Normalization can eliminate errors in the TG Level. Before using this function, connect the **[TG SOURCE]** output terminal of the TG with the **[RF INPUT]** input terminal of the analyzer.

The reference trace can be stored by pressing the "Store Ref" button after the current sweep finished. Then the normalize function can be enabled. When normalization is enabled, the corresponding value

of the reference trace will be subtracted from the trace data after every sweep.

The reference trace must be stored before the normalize function can be used.

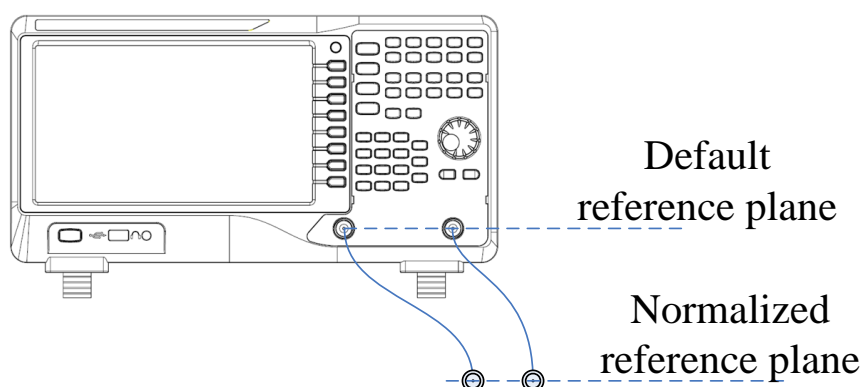

Figure 2-8 Normalize

2.2.7.5 Store Ref

Before enable the normalize function, you should press the “Store Ref” button to store the data of Trace A to Trace D. Then Trace D is the reference trace.

- ◆ The tracking generator needs to be turned on first, and the reference trace can be saved only when the first screen is scanned.
- ◆ The normalization can be enabled only after the reference trace is stored.
- ◆ After you stored the reference trace and enabled the normalization, if then you change some parameters which will change the sweep frequency and sweep time, the "UNCAL" sign will be displayed in the upper left corner of the screen, indicating that the reference trace is no longer applicable to the new trace, and prompting you to save the reference trace again.

2.2.7.6 Ref Trace

Set whether to display the reference trace or not. If “View” is selected, the reference trace saved (Trace D) will be shown in “View” type.

Note: When normalization is enabled, the unit of Y-axis is “dB” and will not be influenced by the definition in **AMPT->Units**. At this point, “(dB)” is displayed under the Y-axis scale in the user interface.

2.2.7.7 Norm Ref Level

Adjust the vertical position of the trace on the screen by adjusting the reference level when normalization is enabled.

This operation differs from the **Ref Level** function in the **AMPT** menu. This parameter has no influence on the reference level of the analyzer.

Table 2-25 Reference level under normalization

Parameter	Explanation
Default	0 dB
Range	-200 dB ~ 200 dB
Unit	dB
Knob Step	1 dB
Direction Key Step	10 dB

2.2.7.8 Norm Ref Pos

Adjust the vertical position of the normalization reference level on the screen by adjusting the reference position when normalization is enabled.

- ◆ The function of this menu is similar to that of **Norm Ref Level**. When it is set to 0%, the normalization reference level is displayed at the bottom of the screen grid and at the top when it is set to 100%.

Table 2-26 TG reference position under normalization

Parameter	Explanation
Default	100%
Range	0 ~ 100%
Unit	100%
Knob Step	1%
Direction Key Step	10%

2.2.8 Demod

Press **Demod** at the front panel to enter the demodulation setting menu. Both AM and FM demodulations are available on the analyzer.

2.2.8.1 Demod (AM/FM)

Set the demodulation type to AM or FM or off. The default is off.

- ◆ The analyzer features an earphone jack and the demodulated signal can be output in audio frequency (AF) mode through the earphone. The frequency and intensity of AF denotes the frequency and amplitude of the signal respectively.
- ◆ A marker would be enabled automatically, place it at the desired frequency and set a demod time. The analyzer would demod at the marker frequency for the demod time, and then performs a normal sweep.
- ◆ Zero span and linear scale type amplitude can be used to see the time domain waveform of the modulated signal.

More demodulation analysis, please refer to AM/FM modulation analyzer in MA option.

2.2.8.2 Earphone

Set the status of the earphone. When it is on, the demodulated signal can be heard through the earphone during the demodulation. By default, it is off.

2.2.8.3 Volume

Set the volume of the earphone.

Table 2-27 Volume

Parameter	Explanation
Default	6
Range	0 ~ 10
Unit	N/A
Knob Step	1
Direction Key Step	1

2.2.8.4 Demod Time

Set the time for the analyzer to complete a signal demodulation after each sweep.

If the **Earphone** is set to “On”, you will hear the demodulated signal through the earphone during the demodulation. A longer demod dwell time is recommended for demodulating audio signals.

Table 2-28 Demod time

Parameter	Explanation
Default	5 s
Range	5 ms ~ 1000 s
Unit	ks, s, ms, us
Knob Step	0 ms ~ 100 ms, step = 1 ms 100 ms ~ 1 s, step = 10 ms 1 s ~ 10 s, step = 100 ms 10 s ~ 100 s, step = 1 s 100 s ~ 1000 s, step = 10 s
Direction Key Step	In 1-2-5 step sequence

2.3 Marker

2.3.1 Marker

The marker appears as a rhombic sign (as shown below) for identifying points on a trace. You can easily read the amplitude, frequency and sweep time of the marked point on the trace.

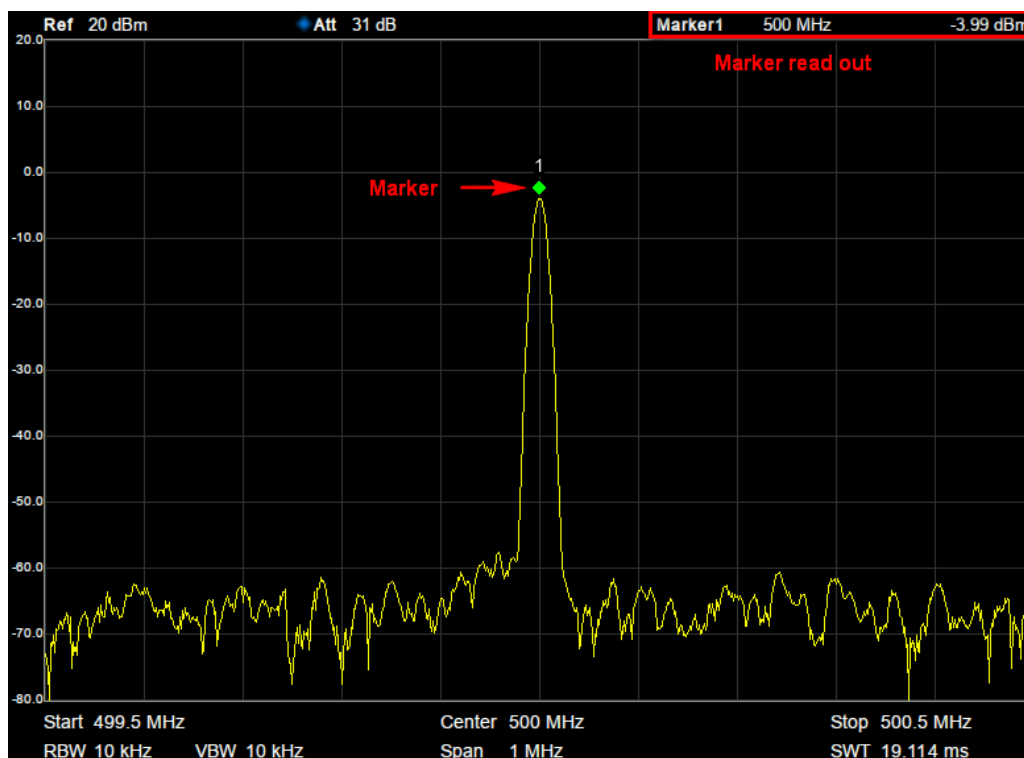

Figure 2-9 Marker

- ◆ The analyzer allows for up to eight/four pairs of markers to be displayed at one time, but only one pair or a single marker is active every time.
- ◆ You can use the numeric keys, knob or direction keys to modify the desired frequency or time as well as view the readouts of different points on the trace.

2.3.1.1 Select Marker

Select one of the eight markers. The default is Marker1. When a marker is selected, you can set its type, trace to be marked, readout type and other related parameters. The enabled marker will appear on the trace selected through the **Select Trace** option and the readouts of this marker are also displayed in the active function area and at the upper right corner of the screen.

Table 2-29 Marker parameters

Parameter	Explanation
Default	Center Frequency
Range	0 ~ Full Span
Unit	Readout = Frequency: GHz, MHz, kHz, Hz Readout = Time or Period: s, ms, us, ns, ps
Knob Step	Readout = Frequency, Step = Span/(Sweep Points - 1) Readout = Time or Period, Step = Sweep Time/(Sweep Points - 1)
Direction Key Step	Readout = Frequency, Step = Span/10 Readout = Time or Period, Step = Sweep Time/10

2.3.1.2 Select Trace

Select the trace to be marked by the current marker. Valid selections include A, B, C, or D.

2.3.1.3 Normal

One of the marker types. It is used to measure the X (Frequency or Time) and Y (Amplitude) values of a certain point on the trace. When selected, a marker with the number of the current marker (such as "1") appears on the trace.

- ◆ If no active marker exists currently, a marker will be enabled automatically at the center frequency of the current trace.
- ◆ You can use the numeric keys, knob or direction keys to move the marker. The readouts of the marker will be displayed at the upper right corner of the screen.
- ◆ The readout resolution of the X-axis (frequency or time) is related to the span. For higher readout resolution, reduce the span.

2.3.1.4 Delta

One of the marker types. It is used to measure the delta values of X (Frequency or Time) and Y (Amplitude) between the reference point and a certain point on the trace. When selected, a pair of markers appears on the trace: Fixed Related Marker (marked by a combination of the marker number and letter "+", such as "2+") and the Delta Marker (marked by the "Δ", such as "1Δ2").

- ◆ After the marker selects "Delta", the original marker will become the delta measurement marker, and the related marker of the incrementing sequence number will become the reference "fixed" marker
- ◆ The delta marker is in the "relative to" state, and its X-axis position can be changed; the related marker is in the "fixed" state by default (the X-axis and Y-axis positions are fixed), but the X-axis can be adjusted by changing to the "normal" state.
- ◆ The first row in the upper right corner of the trace area shows the frequency (or time) difference and amplitude difference between the two markers; the second row in the upper right corner of the trace area shows the X axis and amplitude value of the related marker.

2.3.1.5 Fixed

One of the marker types. When “Fixed” is selected, the X-axis and Y-axis of the marker will not change by the trace and can only be changed through the menu. The fixed marker is marked with "+". After the marker selects “Delta”, the original marker will become the delta measurement marker, and the related marker of the incrementing sequence number will become the reference “fixed” marker

2.3.1.6 Off

Turn off the marker currently selected. The marker information displayed on the screen and functions based on the marker will also be turned off.

2.3.1.7 Relative To

“Relative to” is used to measure the delta values of X (Frequency or Time) and Y (Amplitude) between two markers which can mark on different traces. After the marker selects “Delta”, the original marker will become the delta measurement marker, and the related marker of the incrementing sequence number will become the reference “fixed” marker

2.3.1.8 Marker Table

Enable or disable the Marker Table. Display all the markers enabled on the lower portion of the screen, including marker number, trace number, marker readout type, X-axis readout and amplitude. Through this table you can view the measurement values of multiple points. The table allows for up to eight markers to be displayed at one time.

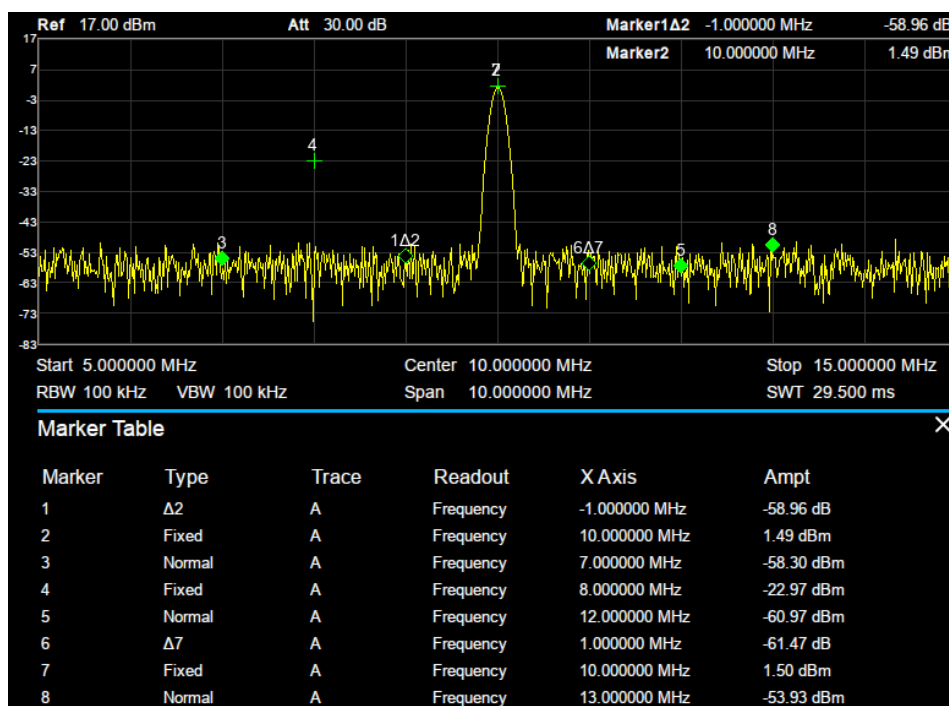

Figure 2-10 Marker table

2.3.2 Marker ->

1. M->CF

Set the center frequency of the analyzer to the frequency of the current marker.

- ◆ If the **Normal** marker is selected, the center frequency will be set to the frequency of the current marker.
- ◆ If the **Delta** or **Delta Pair** marker is selected, the center frequency will be set to the frequency of the Delta Marker.
- ◆ The function is invalid in Zero span.

2. M -> CF Step

Set the center frequency step of the analyzer to the frequency of the current marker.

- ◆ If the **Normal** marker is selected, the center frequency step will be set to the frequency of the current marker.
- ◆ If the **Delta** or **Delta Pair** marker is selected, the center frequency step will be set to the frequency of the Delta Marker.
- ◆ The function is invalid in Zero span.

3. M -> Start Freq

Set the start frequency of the analyzer to the frequency of the current marker.

- ◆ If the **Normal** marker is selected, the start frequency will be set to the frequency of the current marker.
- ◆ If the **Delta** or **Delta Pair** marker is selected, the start frequency will be set to the frequency of the Delta Marker.
- ◆ The function is invalid in Zero span.

4. M -> Stop Freq

Set the stop frequency of the analyzer to the frequency of the current marker.

- ◆ If the **Normal** marker is selected, the stop frequency will be set to the frequency of the current marker.
- ◆ If the **Delta** or **Delta Pair** marker is selected, the stop frequency will be set to the frequency of the Delta Marker.
- ◆ The function is invalid in Zero span.

5. M ->Ref Level

Set the reference level of the analyzer to the amplitude of the current marker.

- ◆ If the **Normal** marker is selected, the reference level will be set to the amplitude of the current marker.
- ◆ If the **Delta** or **Delta Pair** marker is selected, the reference level will be set to the amplitude of the Delta Marker.

6. Δ M->Span

Set the span of the analyzer to the frequency difference between the two markers in Delta marker type.

- ◆ If the **Normal** marker is selected, this function is invalid.

- ◆ The function is invalid in Zero span.

7. $\Delta M \rightarrow CF$

Set the center frequency of the analyzer to the frequency difference between the two markers in **Delta** marker type.

- ◆ If the **Normal** marker is selected, this function is invalid.
- ◆ The function is invalid in Zero span.

2.3.3 Marker Fn

Special marker functions including Noise Marker, N dB BW and Freq Counter.

2.3.3.1 Select Marker

Select one of the eight markers (1, 2, 3, 4, 5, 6, 7 and 8) and the default is Marker1.

2.3.3.2 Noise Marker

Execute the Noise marker function for the selected marker and read the normalized noise power spectral density.

- ◆ If the current marker is “**Off**” in the Marker menu, pressing **Noise Marker** will first set it to Normal type automatically; then measure the average noise level at the marked point and normalize this value to 1 Hz bandwidth. During this process, certain compensation is always made on the basis of the detection and trace types. The measurement will be more precise if RMS Avg or Sample detection type is used.
- ◆ This function can be used for measuring the C/N ratio.

2.3.3.3 N dB BW

Enable the N dB BW measurement or set the value of N dB. The N dB BW denotes the frequency difference between two points that are located on both sides of the current marker and with N dB fall ($N < 0$) or rise ($N > 0$) in amplitude as shown in the figure on the next page.

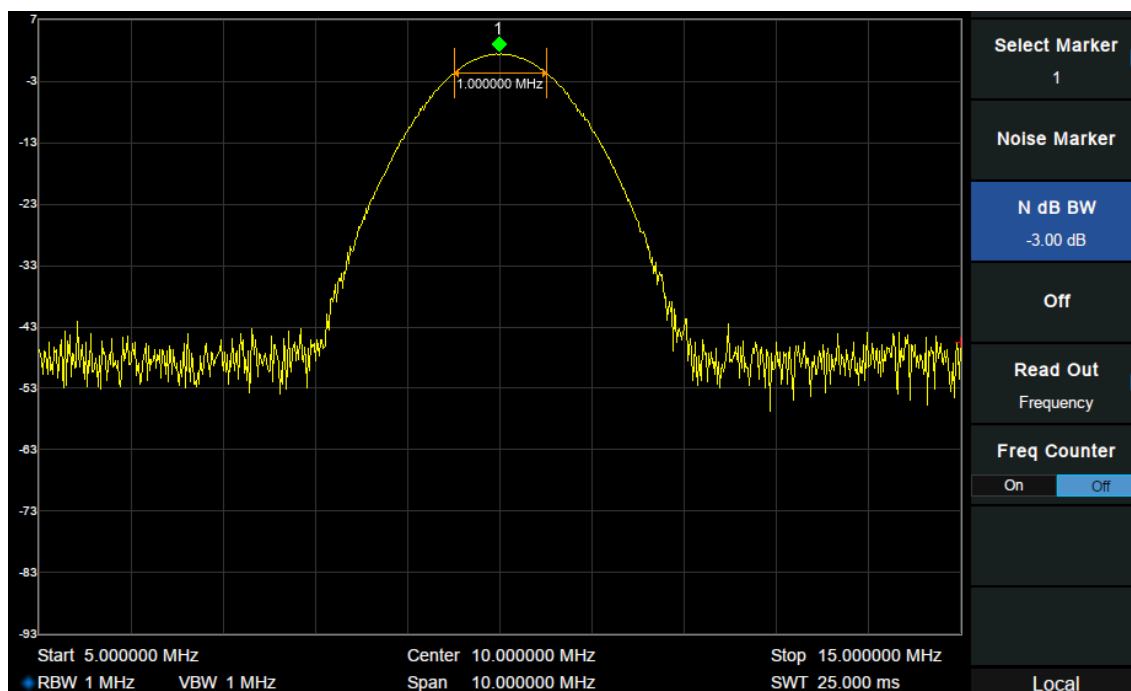

Figure 2-11 N dB BW

When the measurement starts, the analyzer will search for the two points which are located at both sides of the current point with N dB fall or rise in amplitude and display the frequency difference between the two points in the active function area. "----" would be displayed if the search fails.

Table 2-30 N dB Noise

Parameter	Explanation
Default	-3 dB
Range	-100 dB ~ 100 dB
Unit	dB
Knob Step	0.1 dB
Direction Key Step	1 dB

2.3.3.4 Freq Counter

Turn on or off the frequency counter. The frequency readout is accuracy is up to 0.01 Hz.

- ◆ The function is valid only when selecting marker 1.
- ◆ If marker 1 is selected but not active, turning on the frequency counter will open marker 1 Normal marker automatically.
- ◆ The frequency counter measures the frequency near the center frequency in Zero span.

2.3.3.5 Off

Turn off the noise marker, N dB BW measurement or Frequency Counter, but not the marker itself.

2.3.3.6 Read Out

Select a desired readout type for the X-axis for the marker. Different markers can use different readout types. This setting will change the readout type and affect the marker readings in the active function area and at the upper right corner of the screen, but will not change the actual value.

1. Frequency

In this type, Normal marker shows the absolute frequency. Delta markers and Delta Pair markers show the frequency difference between the delta marker and reference marker. The default readout mode in non-zero span is “**Frequency**”.

Note: This type is invalid in Zero span.

2. Period

In this type, the Normal marker shows the reciprocal of frequency; while Delta marker and Delta Pair marker show the reciprocal of frequency difference. When the frequency difference is zero, the reciprocal is infinite and 100 Ts is displayed.

Note: This type is invalid in Zero span.

3. Δ Time

In this type, the Normal marker shows the time difference between the marker and the start of the sweep; while Delta marker and Delta Pair marker show the sweep time difference between the delta marker and reference marker.

The default readout mode in Zero span is Δ Time.

2.3.4 Peak

Open the peak search setting menu and execute peak search.

2.3.4.1 Peak -> CF

Execute peak search and set the center frequency of the analyzer to the frequency of the peak.

2.3.4.2 Next Peak

Search for and mark the peak whose amplitude is closest to that of the current peak and which meets the peak search condition.

2.3.4.3 Next Left Peak

Search for and mark the nearest peak which is located at the left side of the current peak and meets the peak search condition.

2.3.4.4 Next Right Peak

Search for and mark the nearest peak which is located at the right side of the current peak and meets the peak search condition.

2.3.4.5 Peak Peak

Execute peak search and minimum search at the same time and mark the results with delta pair markers. Wherein, the result of peak search is marked with the delta marker and the result of minimum search is marked with the reference marker.

2.3.4.6 Count Peak

Enable or disable continuous peak search. The default is Off. When enabled, the system will always execute a peak search automatically after each sweep in order to track the signal under measurement.

2.3.4.7 Peak Table

Open the peak table (in the lower window) which lists the peaks (with frequency and amplitude) that meet the peak search condition. Up to 16 peaks can be displayed in the table.

2.3.4.8 Search Config

Define the conditions of peak search for various peak searches. A real peak should meet the requirements of both the “**Peak Excursion**” and “**Peak Threshold**”.

1. Peak Threshold

Assign a minimum for the peak amplitude. Peaks whose amplitudes are greater than the specified peak threshold are treated as real peaks.

Table 2-31 Peak Threshold

Parameter	Explanation
Default	-140 dBm
Range	-200 dBm ~ 200 dBm
Unit	dBm
Knob Step	1 dB
Direction Key Step	5 dB

2. Peak Excursion

Set the excursion between the peak and the minimum amplitude on both sides of it. Peaks whose excursions are beyond the specified excursion are treated as real peaks.

Table 2-32 Peak Excursion

Parameter	Explanation
Default	15 dB
Range	0 dB ~ 200 dB
Unit	dB
Knob Step	1 dB
Direction Key Step	5 dB

3. Peak Type

Set the peak search condition. The available options are Maximum and Minimum.

2.4 Measurement

2.4.1 Meas

Provide optional measurement functions. When activated, the screen will be divided into two parts. The above part is the measure screen which displays traces, and the other part is used to display measurement results.

2.4.1.1 Channel Power

Measure the power and power density within the specified channel bandwidth. When this function is enabled, the span and resolution bandwidth are automatically adjusted to smaller values. Select **Channel Power** and press **Meas Setup** to set the corresponding parameters.

2.4.1.2 ACPR

Measure the power of the main channel and adjacent channels as well as the power difference between the main channel and each of the adjacent channels. When this function is enabled, the span and resolution bandwidth of the analyzer are adjusted to smaller values automatically.

Select **ACPR** and press **Meas Setup** to set the corresponding parameters.

2.4.1.3 Occupied BW

Integrates the power within the whole span and calculates the bandwidth occupied by this power according to the specified power ratio. The OBW function also indicates the difference (namely "Transmit Freq Error") between the center frequency of the channel under measurement and the center frequency of the analyzer. Select **Occupied BW** and press **Meas Setup** to set the corresponding parameters.

2.4.1.4 T-Power

The system enters Zero span and calculates the power within the time domain. The types of powers available include Peak, Average and RMS. Select **T-Power** and press **Meas Setup** to set the corresponding parameters.

2.4.1.5 TOI

Automatic measurement of IP3 (Third order Intercept Point), including the power of fundamental wave and the Third order in the power, and calculate the adjustable Intercept Point.

2.4.1.6 Spectrum Monitor

Display the power of the swept spectrum as an intensity color map commonly referred to as a waterfall chart. Select **Spectrum Monitor** and press **Meas Setup** to set the corresponding parameters.

2.4.1.7 CNR

Measure the power of the carrier and noise of the specified bandwidth and their ratio. Select **CNR** and press **Meas Setup** to set the corresponding parameters.

2.4.1.8 Harmonics

The harmonic power and total harmonic distortion of carrier signal are measured. The maximum measurable harmonic is 10th harmonic. The fundamental wave amplitude of carrier signal must be greater than - 50 dBm, otherwise the measurement result is invalid. Select **Harmonics** and press **Meas Setup** to set the corresponding parameters.

2.4.1.9 Meas Off

Turn off all the Meas functions.

2.4.2 Meas setup

2.4.2.1 Channel Power

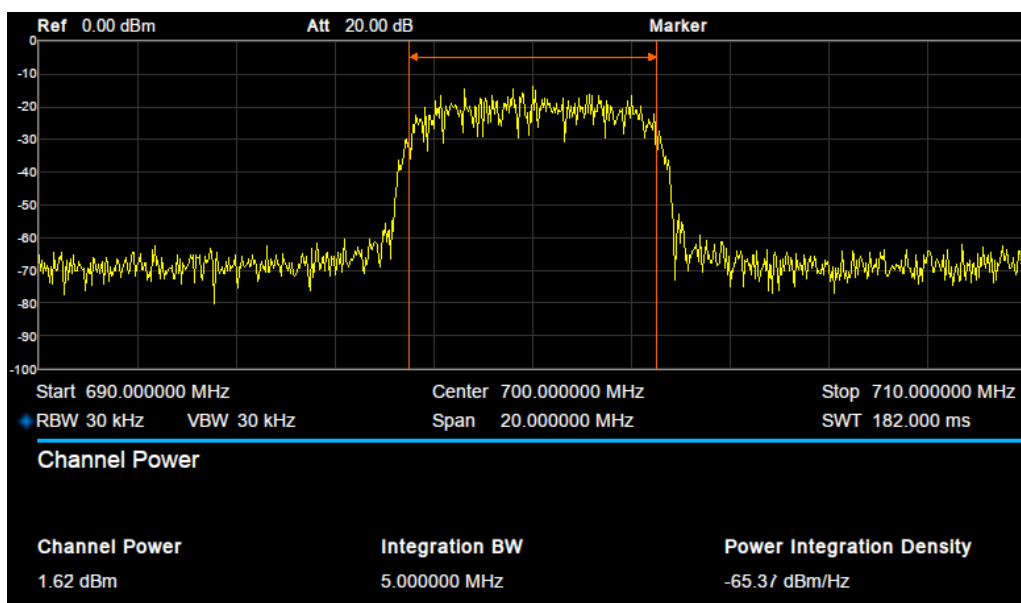

Figure 2-12 Channel Power

Measurement Results: Channel power and power spectral density.

- ◆ Channel Power: Power within the integration bandwidth.
- ◆ Power Spectral Density: Power (in dBm/Hz) normalized to 1Hz within the integration bandwidth.

Measurement Parameters: Center Freq, Integration BW, Span, Span power.

1. Center Freq

Set the center frequency, this center frequency which is the same with the center frequency of the analyzer. Modifying this parameter will change the center frequency of the analyzer.

2. Integration BW

Set the frequency width of the channel to be tested and the power of the channel is the power integral within this bandwidth. You can use the numeric keys, knob or direction keys to modify this parameter.

Table 2-33 Integration BW

Parameter	Explanation
Default	2 MHz
Range	100 Hz ~ Span
Unit	GHz, MHz, kHz, Hz
Knob Step	Integration BW/100, the minimum is 1 Hz
Direction Key Step	In 1-1.5-2-3-5-7.5 sequence

3. Span

Set the frequency range of the channel. This span which is the same with the span of the analyzer is the frequency range of the sweep. Modifying this parameter will change the span of the analyzer.

The channel power span is related to the integration bandwidth.

Table 2-34 Channel Power Span for Chan Power Measurement

Parameter	Explanation
Default	current span
Range	100 Hz ~ Span
Unit	GHz, MHz, kHz, Hz
Knob Step	Channel Power Span/100, the minimum is 1Hz
Direction Key Step	In 1-1.5-2-3-5-7.5 sequence

4. Span Power

Set the integrated bandwidth to the sweep span of display. The channel power and power spectral density display on the screen simultaneously.

2.4.2.2 ACPR

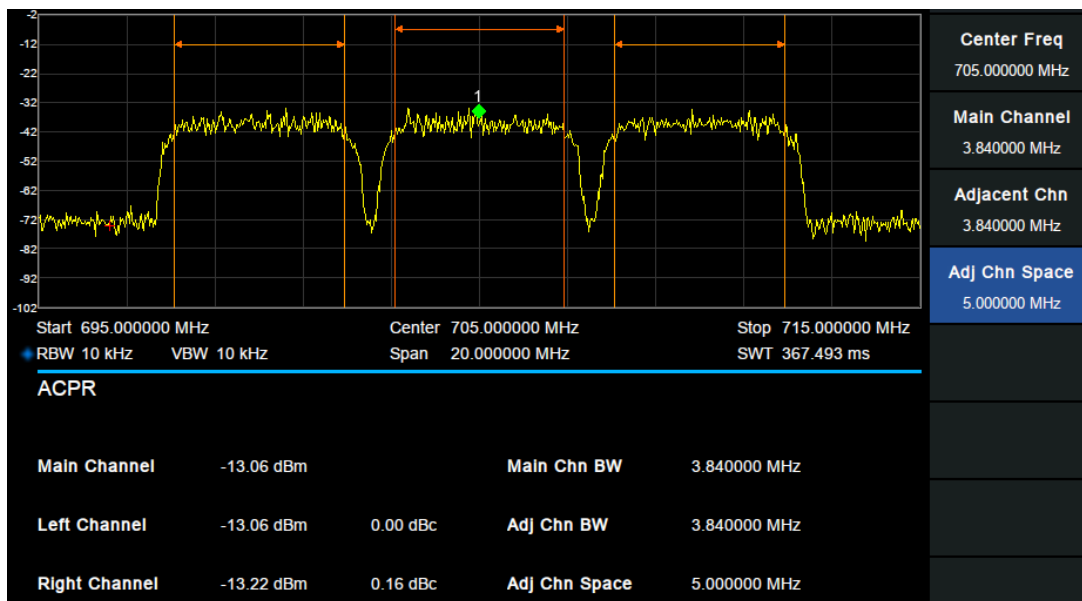

Figure 2-13 ACPR

Measurement Results: Main CH Power, Left channel power and Right channel power.

- ◆ Main CH Power: Displays the power within the bandwidth of the main power
- ◆ Left channel power : Displays the power of left channel and the power difference between the left channel and the main channel (in dBc)
- ◆ Right channel power: Display the power of the right channel and the power difference between the right channel and the main channel(in dBc)

Measurement parameter: Center frequency, main channel bandwidth, adjacent channel bandwidth and channel spacing

1. Center Freq

Set the center frequency. The center frequency is the same with the center frequency of the analyzer display. Modifying this parameter will change the center frequency of the analyzer.

2. Main Channel

Set the bandwidth of the main channel and the power of the main channel is the power integral within this bandwidth.

Table 2-35 Main Channel

Parameter	Explanation
Default	1 MHz
Range	100 Hz ~ full span
Unit	GHz, MHz, kHz, Hz
Knob Step	Main Channel /10, the minimum is 1 Hz
Direction Key Step	In 1-1.5-2-3-5-7.5 Sequence

3. Adjacent Chn

Set the frequency width of the adjacent channels.

The adjacent channel bandwidth is related to the main channel bandwidth.

Table 2-36 Adjacent channel bandwidth

Parameter	Explanation
Default	1 MHz
Range	100 Hz ~ (full span - 2*100 Hz)
Unit	GHz, MHz, kHz, Hz
Knob Step	Adjacent Chn/10, the minimum is 1 Hz
Direction Key Step	In 1-1.5-2-3-5-7.5 Sequence

4. Adj Chn space

Set the difference between the center frequency of the main channel and the center frequency of the adjacent channels.

Adjusting this parameter will also adjust the distance between the upper/lower channel and the main channel.

Table 2-37 adjacent channel space

Parameter	Explanation
Default	3 MHz
Range	100 Hz ~ (full span - 100 Hz) / 2
Unit	GHz, MHz, kHz, Hz
Knob Step	Adj Chn space /10, the minimum is 1 Hz
Direction Key Step	In 1-1.5-2-3-5-7.5 Sequence

2.4.2.3 OBW

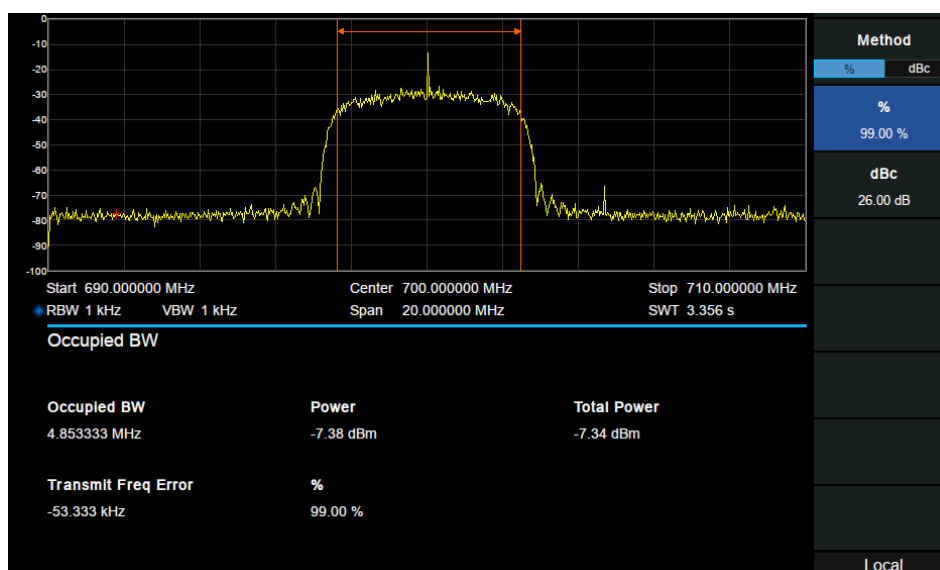

Figure 2-14 OBW

Measurement Results: occupied bandwidth and transmit frequency error.

- ◆ **Occupied Bandwidth:** Integrates the power within the whole span and then calculates the bandwidth occupied by the power according to the specified power ratio.
- ◆ **Transmit Frequency Error:** The difference between the center frequency of the channel and the center frequency of the analyzer.

2.4.2.4 T-Power

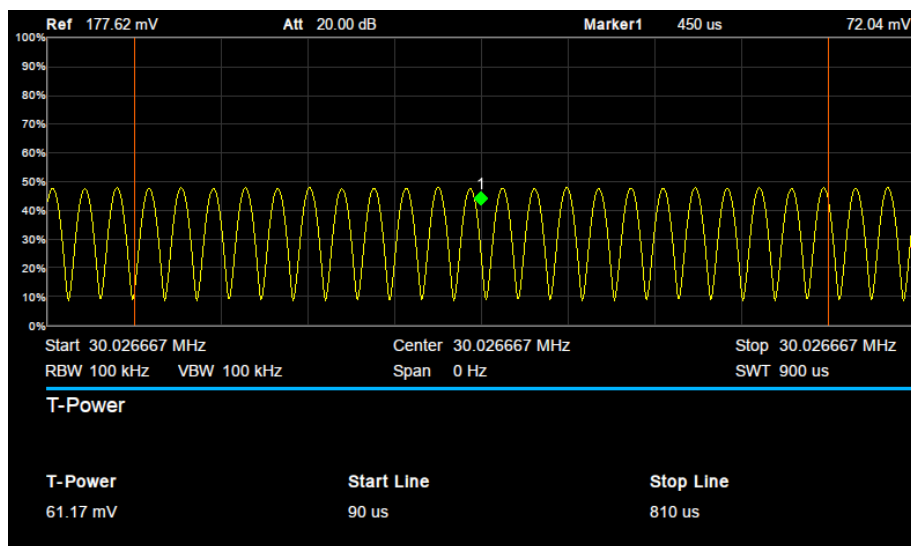

Figure 2-15 T-Power

Measurement Results: T-Power

- ◆ T-Power: The power of the signal from the start line to the stop line.

Measurement Parameter: Center frequency, start line, stop line.

1. Center Frequency

Set the center frequency, this center frequency which is the same with the center frequency of the analyzer. Modifying this parameter will change the center frequency of the analyzer.

2. Start line

Set the left margin (in time unit) of T-Power measurement. The data calculated under this measurement is between the start line and stop line.

Table 2-38 start line

Parameter	Explanation
Default	0 s
Range	0 s ~ stop line
Unit	ks, s, ms, us, ns
Knob Step	Sweep time/751
Direction Key Step	In 1-1.5-2-3-5-7.5 Sequence

3. Stop line

Set the right margin (in time unit) of T-Power measurement. The data calculated under this measurement is between the start line and stop line.

Table 2-39 stop line

Parameter	Explanation
Default	900 us
Range	Start line ~ sweep time
Unit	ks, s, ms, us, ns
Knob Step	Sweep time /751
Direction Key Step	In 1-1.5-2-3-5-7.5 Sequence

2.4.2.5 TOI

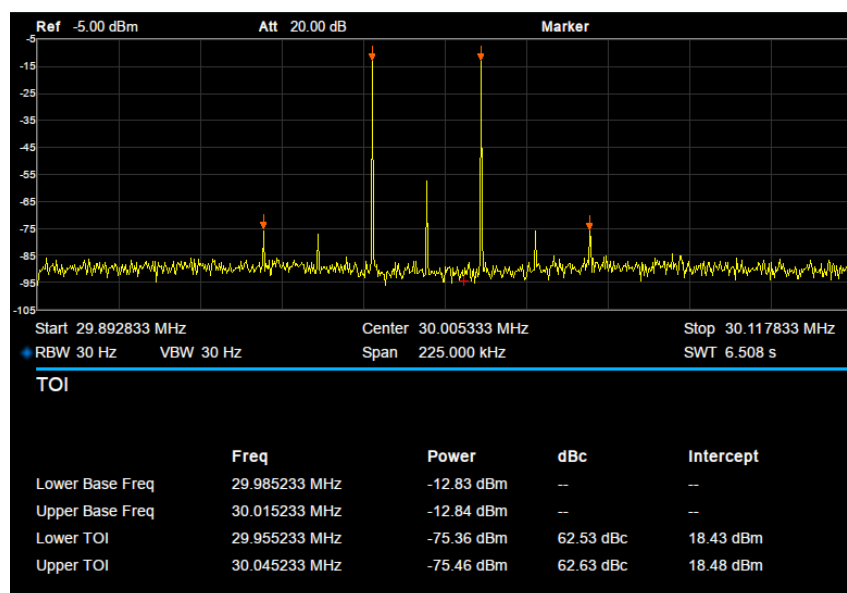

Figure 2-16 TOI

TOI is an automatic measurement. There are no user controlled parameters.

2.4.2.6 Spectrum Monitor

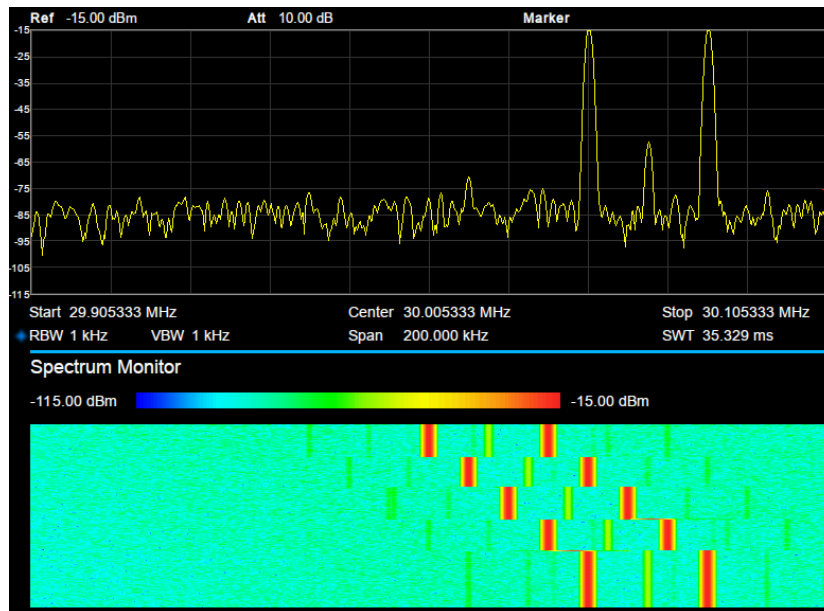

Figure 2-17 Spectrum Monitor

Display the power of spectrum of successive scans as a color map. Also call a waterfall chart.

Measurement Parameter: Spectrogram, Restart.

1. **Spectrogram:** Sets the meas state of spectrum monitor.
2. **Restart:** clear the measurement and then restart it.

2.4.2.7 CNR

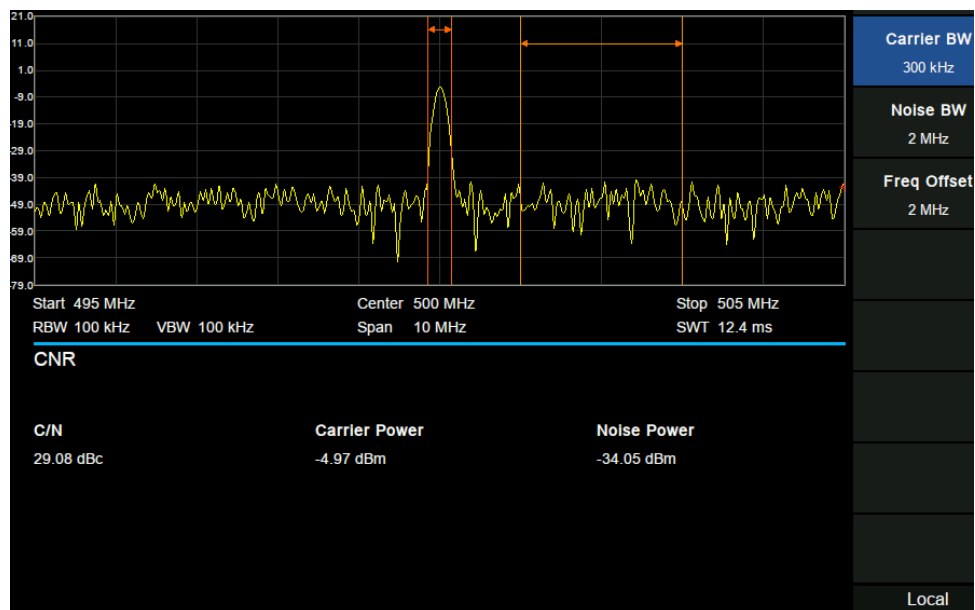

Figure 2-18 CNR

Measurement Results: C/N, Carrier Power, Noise Power.

- ◆ C/N: the ratio of Carrier Power to Noise Power.
- ◆ Carrier Power: the total power of the carrier bandwidth.
- ◆ Noise Power: the total power of the selected noise bandwidth.

Measurement Parameter: Carrier BW, Noise BW, Freq Offset.

1. Carrier BW

Set the bandwidth of the carrier to be measured.

Table 2-40 Carrier BW

Parameter	Explanation
Default	3 MHz
Range	100 Hz ~ (2*span - 2* Freq Offset - Noise BW)
Unit	GHz, MHz, kHz, Hz
Knob Step	Carrier BW /10, the minimum is 1 Hz
Direction Key Step	In 1-1.5-2-3-5-7.5 Sequence

2. Noise BW

Set the bandwidth of the noise to be measured.

Table 2-41 Noise BW

Parameter	Explanation
Default	3 MHz
Range	100 Hz ~ (2*span - 2* Freq Offset - Carrier BW)
Unit	GHz, MHz, kHz, Hz
Knob Step	Noise BW /10, the minimum is 1 Hz
Direction Key Step	In 1-1.5-2-3-5-7.5 Sequence

3. Freq Offset

Set the difference between carrier center frequency and noise center frequency.

Table 2-42 Freq Offset

Parameter	Explanation
Default	3 MHz
Range	-(span - (Carrier BW + Noise BW) /2) ~ (span - (Carrier BW + Noise BW) /2)
Unit	GHz, MHz, kHz, Hz
Knob Step	Freq Offset /10, the minimum is 1 Hz
Direction Key Step	In 1-1.5-2-3-5-7.5 Sequence

2.4.2.8 Harmonics

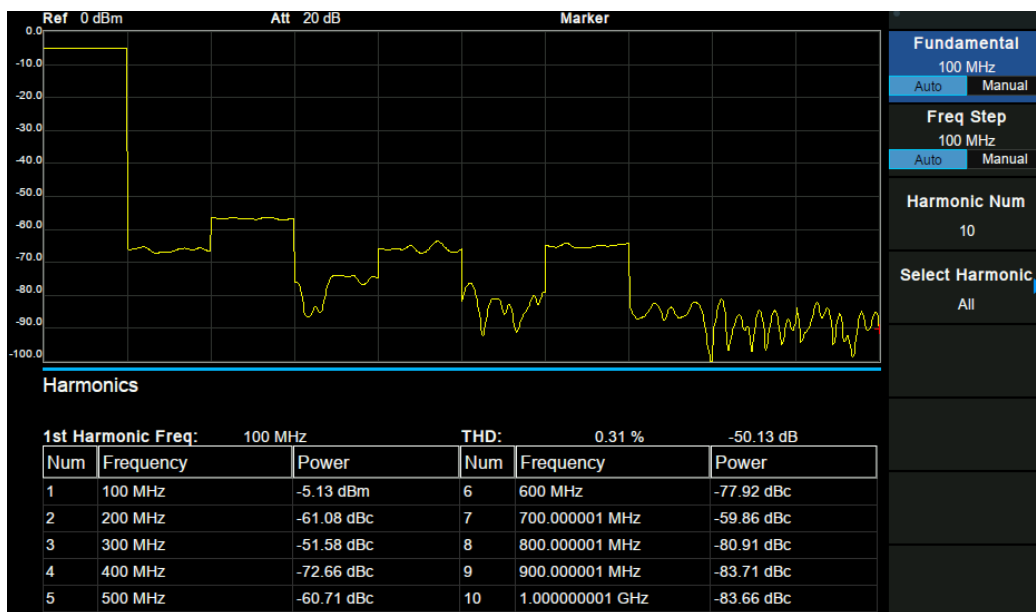

Figure 2-19 Harmonics

Measurement Results: each harmonic amplitude and total harmonic distortion of carrier signal. It can measure up to 10th harmonic.

Measurement Parameter:

1. Fundamental

Set the frequency of the fundamental wave.

If the automatic mode is turned on, the fundamental wave will be automatically found from the first scan.

If the automatic mode is turned off, the user can input the fundamental frequency manually.

2. Freq Step

Set the harmonic step. In auto mode, the frequency of a harmonic is a multiple of the fundamental frequency.

3. Harmonic Num

Set the total number of the harmonics to be measured.

Table 2-43 Harmonic Num

Parameter	Explanation
Default	10
Range	2 ~ 10
Unit	None
Knob Step	1
Direction Key Step	1

4. Select Harmonic

When "All" is selected, the trace shows the fundamental wave and all harmonics in the sweep bandwidth.

When 1-10 is selected, the trace shows a zero span trace corresponding to the fundamental wave or the measured harmonic.

Chapter 3 Modulation Analyzer

This chapter introduces in detail the function keys and menu functions of the front panel under the Modulation Analyzer Mode.

This mode enables modulation analysis of incoming signals. Modulation types are as follows:

- ◆ AM analog modulation
- ◆ FM analog modulation
- ◆ ASK digital modulation
- ◆ FSK digital modulation
 - 2FSK, 4FSK, 8FSK, 16FSK
- ◆ MSK digital modulation
- ◆ PSK digital modulation
 - BPSK, QPSK, 8PSK, DBPSK, DQPSK, D8PSK, Pi/4 DQPSK, Pi/8 D8PSK, OQPSK
- ◆ QAM digital modulation
 - 16QAM, 32QAM, 64QAM, 128QAM, 256QAM

Meas menu may be different in different modulation types.

The modulation type can be re-selected by pressing the **Meas** key.

Subjects in this chapter:

- ◆ Basic Settings
- ◆ Measurement
- ◆ Sweep and Functions

3.1 Basic Settings

3.1.1 Frequency

Switch to the Frequency Settings menu by pressing **Frequency** on the front panel. When entering the frequency menu, the “Center Freq” is selected by default.

3.1.1.1 Center Freq

Set the modulated carrier frequency.

Table 3-1 Center Freq

Parameter	Explanation
Default	100 MHz
Range	Full Span
Unit	GHz, MHz, kHz, Hz
Knob Step	Freq Step/10
Direction Key Step	Freq Step

3.1.1.2 Freq Step

Setting the value of Freq Step will change the direction key step and knob step of the center frequency.

Table 3-2 Freq Step

Parameter	Explanation
Default	10 kHz
Range	1 Hz ~ 100 MHz
Unit	GHz, MHz, kHz, Hz
Knob Step	Freq Step/10, min 1 Hz
Direction Key Step	In 1-2-5 sequence

3.2 Measurement

3.2.1 Digital Modulation Analysis

When ASK, FSK, MSK, PSK or QAM modulation type is selected, digital modulation analysis is carried out.

3.2.1.1 Format

Select the modulation format.

3.2.1.2 Symbol Rate

Set the symbol rate of the signal to be analyzed. Press **Meas Setup**, then select "Symbol Rate", you can input the symbol rate and change the symbol rate by the knob.

Table 3-3 Symbol Rate

Parameter	Explanation
Default	10 ksps
Range	1 ksps ~ 2.5 Msps
Unit	Msps, ksps, sps
Knob Step	Symbol Rate/10
Direction Key Step	In 1-2-5 sequence

3.2.1.3 Points/Symbol

Set the points/symbol of the modulated signal.

3.2.1.4 Meas Length

Set the number of symbols which will be used in calculating the measurement. As the length is longer, the range for statistics is bigger, and the measure time is longer.

Table 3-4 Meas Length

Parameter	Explanation
Default	128
Range	16 ~ 4096
Unit	1
Knob Step	1
Direction Key Step	Current value of Meas Length

3.2.1.5 Filter Setup

After entering into the "Filter Setup" sub-menu, you can choose the relative parameters of filters.

1. Measure Filter

- ◆ Sqrt Nyquist
- ◆ Nyquist
- ◆ Gauss
- ◆ Half Sine
- ◆ Off

2. Reference Filter

- ◆ Sqrt Nyquist
- ◆ Nyquist

- ◆ Gauss
- ◆ Half Sine
- ◆ Off

Note: The rule of common filter type selected

Transmitter Filter	Measure Filter	Reference Filter
Sqrt Nyquist	Sqrt Nyquist	Nyquist
Nyquist	Off	Nyquist
Gauss	Off	Gauss
Half Sine	Off	Half Sine

3. Filter Alpha/BT

- ◆ For Sqrt Nyquist and Nyquist filter settings, you can set the alpha parameter. It can be set the same as the transmitter.
- ◆ For a Gauss filter, use the BT parameter. It can be set the same as the transmitter.

Table 3-5 Filter Parameter

Parameter	Explanation
Default	0.35
Range	0 ~ 1
Unit	1
Knob Step	0.01
Direction Key Step	0.1

4. Filter Length

Set the symbols number of the filter selected. It can be set the same as the transmitter.

Table 3-6 Filter Length

Parameter	Explanation
Default	64
Range	2 ~ 128
Unit	1
Knob Step	1
Direction Key Step	5

3.2.1.6 **Statistic**

1. **Statistic**

Turn on the statistical function, the measurement result will show the maximum and minimum of statistics. Turn off the statistical function, the measurement result will only show the real-time measurement value. Statistical function is turned off by default.

2. Avg

Open and close the average option for the measurement result. It can set the average number. When the Avg Number is set to off, the column title "Average" in numerical results view will be changed to "Current". The "Average" measurement result will be stable if the average number is set to larger values.

Table 3-7 Avg Number

Parameter	Explanation
Default	10
Range	1 ~ 1000
Unit	1
Knob Step	1
Direction Key Step	10

3. Restart Meas

After this function is performed, the statistics will be cleared and restarted. If the average function is turned on, the average calculation of measurement results will be cleared and restarted as well.

3.2.1.7 Trace

The displayed data and format in the measurement windows can be set in **Trace** menu.

1. Select Trace

Select the trace in order to set the corresponding trace parameters. You can also select the trace by clicking on the trace mark displayed in the left status bar of the screen.

2. Num of Traces

Set the upper limit of displayed trace numbers. Up to four traces can be displayed simultaneously in the screen window.

3. Layout

Select the layout of the screen windows. The layout types are as follows:

- Single
- Stacked 2
- Grid 1,2
- Grid 2x2

4. Data

Select the displayed data of the trace.

5. Format

Select the displayed format of the trace.

6. Copy to

Copy the currently selected trace to another trace.

7. Properties

Eye Length

Set the length of the Eye diagram.

Symbol Table

Display the demodulation digital symbols (binary or hex).

3.2.2 Analog Modulation Analysis

When AM or FM modulation type is selected, analog modulation analysis is carried out.

3.2.2.1 IFBW

After entering into the mode AM or FM modulation analysis, set the intermediate frequency bandwidth (IFBW).

Press **Meas Setup**, you can set the "IFBW" again.

It specifies the IFBW of the signal to be analyzed. The measurement accuracy will be impacted if this value isn't set precisely. The IFBW should be as narrow as possible to improve the S/N ratio.

For AM modulation analysis, the IFBW should be larger than twice the modulation frequency. For FM modulation analysis, the IFBW should be larger than twice the sum of the deviation frequency and the modulation frequency.

Table 3-8 IFBW

Parameter	Explanation
Default	1.2 MHz
Range	1.2 MHz, 960 kHz, 600 kHz, 480 kHz, 300 kHz, 240 kHz, 120 kHz, 96 kHz, 60 kHz
Unit	MHz, kHz
Knob Step	Change to the next enumeration value
Direction Key Step	Change to the next enumeration value

3.2.2.2 EqLFP

After entering into the mode AM modulation analysis or FM modulation analysis, set the equivalent low pass filter (EqLFP).

Press **Meas Setup**, you can set the "EqLFP" again.

It specifies the EqLFP bandwidth of the signal to be analyzed. The measurement accuracy will be impacted if this value isn't set precisely. The EqLFP is an additional low pass filter. It can conveniently

measure the lower modulation frequency signal. The EqLPF bandwidth should be as narrow as possible to improve the S/N ratio, but also need to be larger than the modulation frequency.

Table 3-9 EqLPF

Parameter	Explanation
Default	IFBW/6
Range	Off, IFBW/6, IFBW/20, IFBW/60, IFBW/200, IFBW/600, IFBW/2000
Unit	kHz、Hz

3.2.2.3 Average

Open and close the average option for the measurement result. It can set the average number. When the Avg Number is set to off, the column title "Average" in numerical results view will be changed to "Current". The "Average" measurement result will be stable if the average number is set to larger values.

Table 3-10 Avg Number

Parameter	Parameter
Default	10
Range	1 ~ 1000
Unit	1
Knob Step	1
Direction Key Step	10

3.2.2.4 Restart Meas

After this function is performed, the statistics will be cleared and restarted. If the average function is turned on, the average calculation of measurement results will be cleared and restarted as well.

3.3 Sweep and Functions

3.3.1 Trigger

Press **Trigger** to open the menu. The analyzer will begin a sweep only with the selected trigger conditions are met. A trigger event is defined as the point at which your trigger source signal meets the specified trigger level.

- ◆ Free Run: New sweep starts as soon as possible after the current sweep ends.
- ◆ RF Trigger: Activates the trigger condition that starts the next sweep if the detected RF envelops voltage rises to a level set by the RF trigger level.
- ◆ External: The trigger even is the rising or falling edge of the external trigger signal.

3.3.2 Sweep

Select "single" or "continue" type for sweep. Press **Sweep** into the menu. When "single" sweep type is selected, it will start a new sweep if meets the trigger even, after press the menu button "single".

- ◆ Single Sweep
- ◆ Continue Sweep

Chapter 4 System Settings

4.1 System

4.1.1 Language

The analyzer supports a multi-language menu, Chinese and English built-in help and popup messages. Press this key to select the desired display language.

4.1.2 Power On/Preset

4.1.2.1 Power On

Set the power on setting to Default, Last or User.

- ◆ **Def:** Load the default settings, for more details please refer to Table 4-3.
- ◆ **Last:** When Last is selected, instrument settings before the last power-off are recalled automatically at power on.
- ◆ **User:** If power on is set to user, the device will recall the specified configuration after power on.

4.1.2.2 Preset

Set the preset type to Default, Last or User.

- ◆ **Def:** When press **Preset**, load the default settings, for more details please refer to Table 4-3.
- ◆ **Last:** When press **Preset**, load the last power-off settings.
- ◆ **User:** When press **Preset**, load the specified configuration type.

4.1.2.3 User Config

Save the current instrument settings as user-defined setting into the internal non-volatile memory.

4.1.2.4 Factory Reset

When **Factory Reset** is selected, the device will recall the initial config.

4.1.2.5 Reset & Clear

When **Reset & Clear** is selected, the device will recall the initial config and all user data and settings will be erased.

4.1.2.6 Power on Line

Set whether the instrument will start automatically after power-on. Default does not automatically start.

4.1.3 Interface

The analyzer supports communications through LAN, USB and the SIGLENT USB-GPIB adapter as standard remote computer control interfaces.

4.1.3.1 LAN

Configure the related parameters of the LAN connection by “Static” or “DHCP” method. As a default, the IP config is DHCP.

- ◆ Statically setting LAN parameters requires pressing the "Apply" button to make LAN parameters effective.
- ◆ When “DHCP” is pressed, the LAN parameters are dynamically allocated.

The LAN status icon will be displayed in the upper right corner of the screen if the cable is connected.

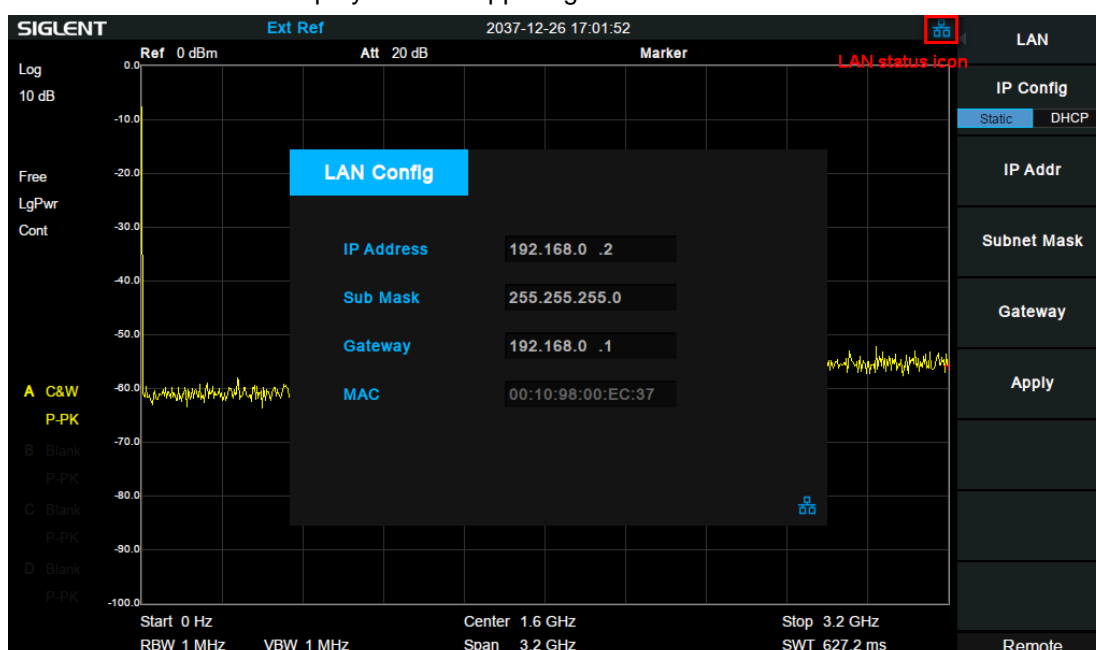

Figure 4-1 LAN Config

4.1.3.2 GPIB

Configure GPIB port number. The analyzer provides a digital interface for use with an optional SIGLENT USB-GPIB module through the front USB port.

4.1.3.3 Web Server

Set web page parameters to use VNC.

1. Port

The port number can be set to 5900~5999. When the port number is set beyond the range, a prompt pops up at the bottom of the screen, and the port number is automatically set to the maximum or minimum value.

After modifying the port number, VNC needs to be reopened.

2. Password

Set the password for login VNC.

3. View Only

Set whether the analyzer is in view-only mode on VNC.

When the view-only mode is turned on, the analyzer can only be viewed and cannot be operated on VNC. When the view-only mode is turned off, the analyzer can be viewed and operated simultaneously on VNC.

After modifying the view-only mode, VNC needs to be reopened.

4.1.4 Calibration

4.1.4.1 Auto Cal

Set whether to turn on the auto calibration or not and turn off by default. When Auto Cal is turned on, the analyzer will process self-calibration according to the temperature difference. Half an hour after startup, the device will query temperature itself every minute. If the temperature difference is greater than 2°, the device will be self-calibrated.

4.1.5 System Info

4.1.5.1 System Info

- Product Model, Serial and HOST ID
- Software Version and Hardware Version
- Option Information

System Info			
Product Info:			
Model	SVA1015X		
Serial	SVA1XCAC2R0006		
Host ID	B302B010183A4781		
Version:			
SW1	01.2.1.2.2R0		
SW2	20190308-1		
SW3	000000C9		
HW	01.01.00		
Option:			
AMK	Sta: On	Valid: Permanent	
EMI	Sta: On	Valid: Permanent	
TG	Sta: On	Valid: Permanent	
DMA	Sta: On	Valid: Permanent	
AMA	Sta: On	Valid: Permanent	

Figure 4-2 System Info

4.1.5.2 Load Option

Press “Load Option” and then enter the sequence code in the pup-up box to load the options. Options can also be loaded by loading License files in **File** ->”Open/Load”.

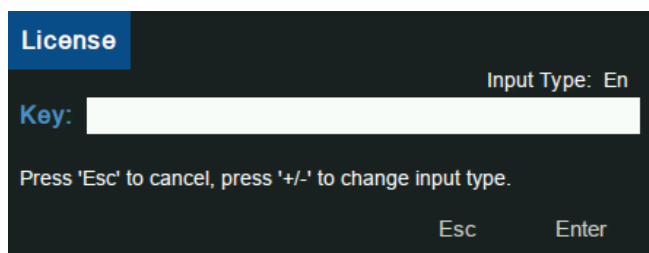

Figure 4-3 Load Option

4.1.5.3 Firmware Update

Press “Firmware Update” and you will enter into the **File** menu. Then you can select *.ADS file from memory to upgrade firmware. After firmware upgrade, the machine will restart.

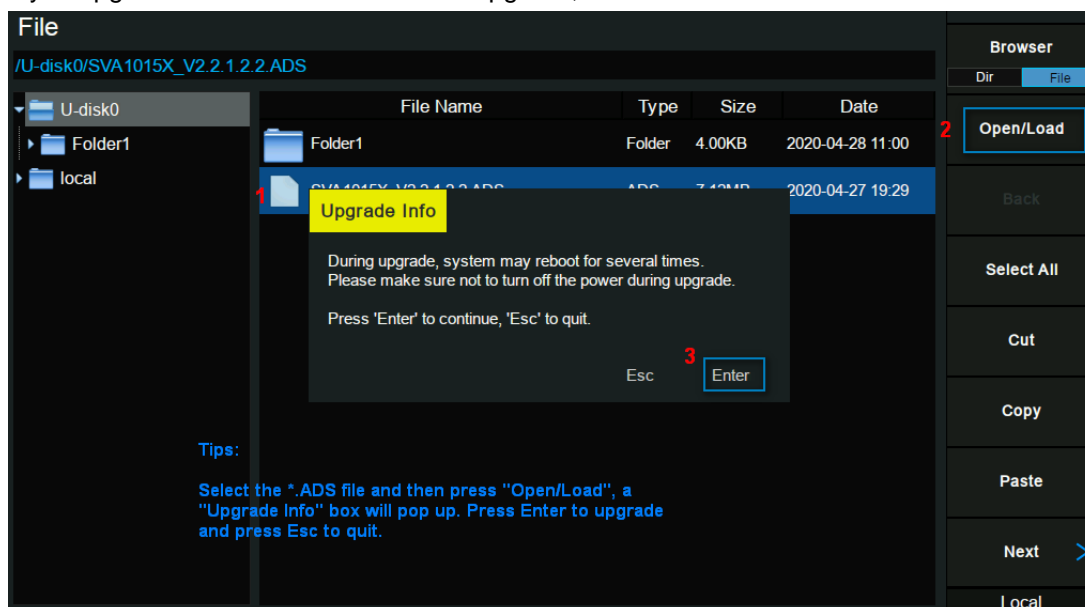

Figure 4-4 Firmware Update

4.1.5.4 System Message

Display system alarms and warnings.

4.1.6 Date and Time

Set system time, and the display status and display format of system time. System time can be set to "ymd", "mdy" or "dmy" formats.

System time is displayed in "ymd" format in the middle of the status bar by default.

4.1.7 Self Test

1. Screen Test

Test whether the screen has any pixel defects by displaying five colors: White, Red, Green, Blue and Black. Press 'Preset' key to switch the screen color and press '←' key to exit the test.

2. Keyboard Test

Enter the keyboard test interface. Press the function keys at the front panel one-by-one and observe whether the corresponding key is checked. If not, an error may have occurred in that key. To exit the test, press '←' four times.

3. LCD Test

If the keys at the front panel are transparent, when the key is pressed, the corresponding backlight will turn on when testing it.

4. Touch Test

Test whether the touch screen has any defects by touching the test button at specific spots on screen.

4.2 Display

Control the display of the screen.

4.2.1 Grid Brightness

Control the display grid brightness.

Table 4-1 Grid brightness

Parameter	Explanation
Default	30%
Range	0 ~ 100%
Unit	None
Knob Step	1%
Direction Key Step	1%

4.2.2 Screenshot

Toggle between normal and inverse color for images of the display saved to storage.

The color of traces is not inverted in inverse mode.

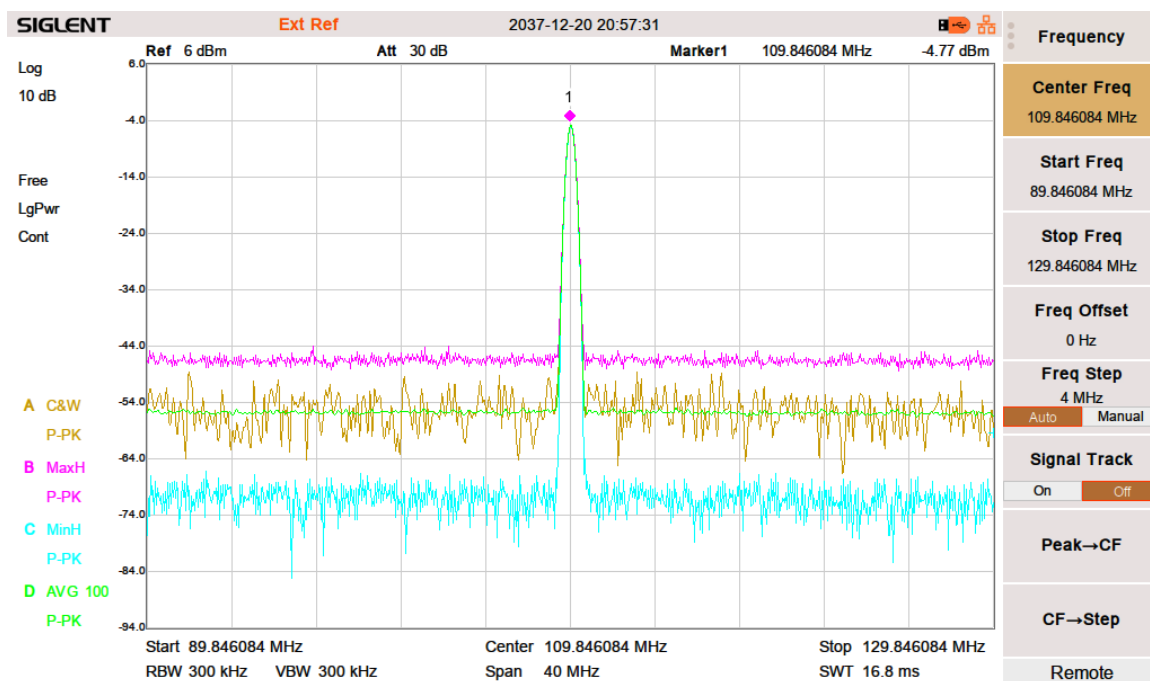

Figure 4-5 Inverse color Screenshot

4.2.3 Touch Settings

You can turn on or off touch screen settings and touch assistance.

Touch assistance can be moved to any position on the screen after the touch screen settings are opened.

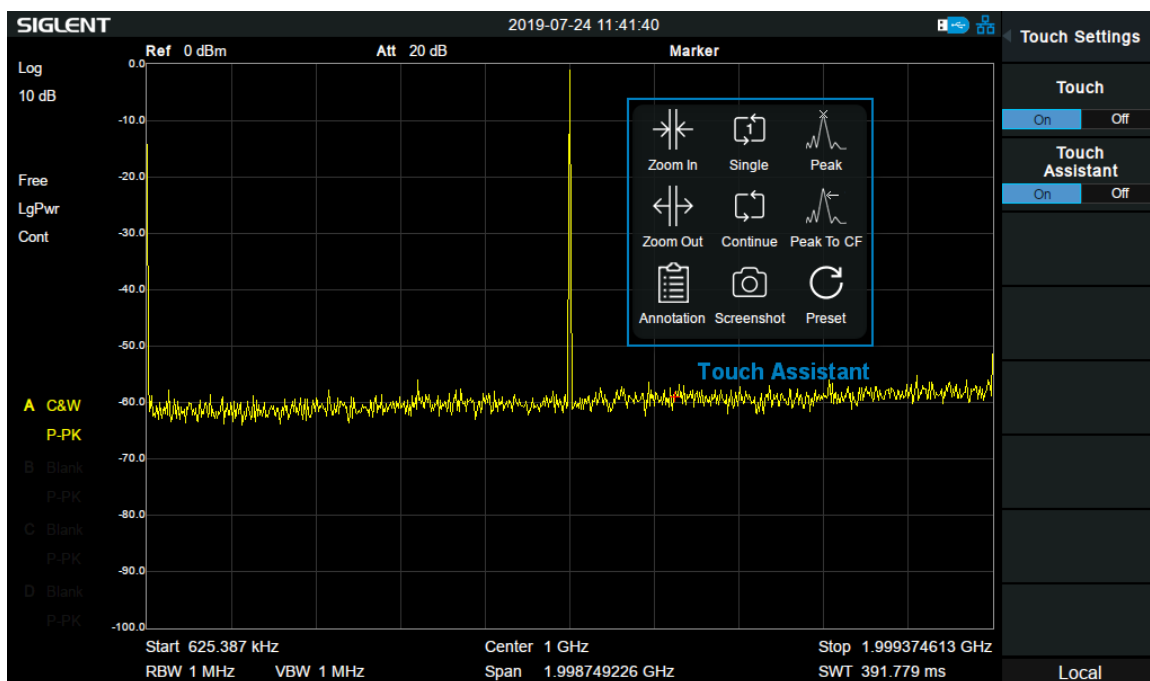

Figure 4-6 Touch assistance

4.2.4 Power Saving

After setting the power saving, the screen backlight can be turned off when there is neither touch screen operation nor button operation for a certain period of time. The screen backlight will be turned on after a touch screen operation or button operation.

4.2.5 Annotation

If turn on the annotation function, you can add annotations on the screen.

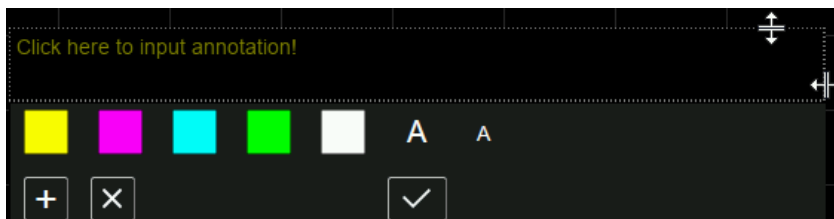

Figure 4-7 Annotation

Typical operation sequence is:

- ◆ Turn on the annotation function: you could activate the annotation function in the Display menu, or toggle the status of the function using the touch assistant.
- ◆ Edit text: Click the input area to invoke the virtual keyboard. Use the virtual keyboard or the keys in the Edit area on the front panel to enter text. During the editing, you could change the color and size of the text using the color label and font size label respectively. Moreover, you could change the size of the input area by dragging the two-way arrows on the top and right.
- ◆ (Optional) Add or delete annotation by clicking the plus sign button and cross sign button. You could add as many as ten annotations. When you delete the last one, it was not really deleted. In fact, the annotation function is turned off.
- ◆ Finish editing: click Enter or Esc button on the virtual keyboard to close the keyboard. Now you could click in the blank space of the annotation widget and drag it to any places on the screen. Click the tick button, only the text would be visible and an annotation is successfully added.

If you want to change one of the annotations, click the text and you could repeat the operation above. Notice that if you change the mode of the analyzer or shut off the analyzer, all the annotations would be removed. Toggling the status of the annotation function won't do that, however.

4.2.6 Display Line

Open or Close Display Line or move the location. The display line can be used as a reference for reading.

Table 4-2 Display Line

Parameter	Explanation
Default	0 dBm
Range	REF Level + REF Offset – 10*Scale/Div ~ REF Level + ref Offset
Unit	dBm
Knob Step	1
Direction Key Step	Scale/Div

4.3 File

4.3.1 Browser

Browser type including “Dir” and “File”,

Dir: When selected, use the knob or direction keys to change the highlighted directory.

File: When selected, use the knob or direction keys to switch among files or sub-folders under the current directory.

4.3.2 Open/Load

Open the selected folder or load the selected file.

4.3.3 Back

If there is a previous directory, return to it.

4.3.4 View Type

Select the type of file to be browsed. Include: “All Type”, “STA”, “TRC”, “COR”, “CSV”, “LIM”, “PIC” (JPG /BMP /PNG).

4.3.5 Save Type

Select the type of file to be saved. The corresponding storage data of various types of files are:

1. STA(Status)

STA files can be used to save and recall the instrument configuration. They are saved in ASCII format, which can be read by humans.

2. TRC(Trace)

TRC files store the active (visible) trace data and scaling factors that were in place when the data was saved. They are saved in ASCII format, which can be read by humans.

Note: When you first recall trace files, the instrument will adjust the display parameters (horizontal and vertical scaling, for example) to match the settings used during data collection. The trace data will not

change, even if you adjust the parameters.

3. COR(Correction)

COR files store the data used to mathematically adjust the displayed input signal based on external factors (Cable loss, Amplifier/Antenna gain, etc.). They are saved in ASCII format, which can be read by humans.

4. CSV(Comma-Separated Variable)

CSV files store instrument configuration (scaling, units, etc.) and raw data (amplitude and frequency values) in ASCII format, commonly viewed in spreadsheet programs like Microsoft® Excel®. This file type can be read by humans

5. LIM(limit)

LIM files store the line or point data used to configure and display lines used for visual indication of a user-defined limit. They are saved in ASCII format, which can be read by humans.

6. BMP(Bitmap) /JPG(JPEG) /PNG

Picture files capture the display of the instrument (screenshot) as an image file. All of the details of the display are captured exactly. What you see on the display is in the file. These are readable using image programs like Microsoft® Paint®.

4.3.6 Save

Save file in current directory, the file type is set in 'Save Type'.

If there is an external memory, it will be saved to the external memory first.

Also used to set the save type of the **Save** shortcut, which can be used to quickly save the files.

4.3.7 Create Folder

Create a new folder in current directory.

4.3.8 Operate

1. Browser

Browse files or directories; use the knob or direction keys to select the corresponding item.

2. Open/Load

Open the selected folder or load the selected file.

3. Back

Return to previous directory

4. Select All

Select all the files and folders in the current directory.

5. Cut

Cut the Selected file or folder, and delete the primary one after paste.

6. Copy

Copy the Selected file or folder for paste.

7. Paste

Paste the file cut or copied before into the current.

8. Delete

Delete the selected file or directory.

9. Rename

Rename the selected file or folder.

4.4 Shortcut Key

4.4.1 Preset

Recall the preset setting and restore the analyzer to a specified status.

- ◆ Press **System** -> "Pwr On/Preset" -> "Preset" to select "Def", "Last" or "User".
- ◆ Press **Preset** to load the factory settings listed in the following table (except items marked with "***") or Last settings or User-defined settings.
- ◆ Different modes have their own Presets. The following table shows the initial default state of the Spectrum Analyzer Mode.

Table 4-3 Default Preset of Spectrum Analyzer Mode

Parameter	Default
Frequency	
Center Freq	750 MHz
Start Freq	0 Hz
Stop Freq	1.5 GHz
Freq Offset	0 Hz
Freq Step	Auto, Span /10
Signal Track	Off
Span	
Span	1.5 GHz
X Scale	Linear

Amplitude	
Ref Level	0 dBm
Attenuator	Auto, 20 dB
Preamp	Off
Units	dBm
Scale/Div	10 dB
Scale Type	Log
Ref Offset	0 dBm
Corrections	Off
RF Input	50 Ω
Apply Corrections	Off
Correction x	Off
Correction x data	Null
BW	
RBW	Auto, 1MHz
VBW	Auto, 1MHz
VBW/RBW	1
Avg Type	Log Pwr
Filter	Gauss
Sweep	
Sweep Time	Auto
Sweep Rule	Speed
Sweep	Continue
Sweep Mode	Auto
Numbers	1
QPD Dwell Time	50 ms
Trig	
Trigger Type	Free Run
Video Trigger	0 dBm
External Trigger	Rising
TG	
TG	Off
TG Level	-20 dBm
TG Lvl Offset	0 dB
Normalize	Off
Norm Ref Lvl	0 dB
Norm Ref Pos	100%
Ref Trace	Blank
Trace	
Select Trace	A
Trace Type of Trace A	Clear Write

Avg Times	100
Output Z	C
Input X	A
Input Y	B
Constant	0 dB
Math Type	Off
Detect	
Select Trace	A
Detect Type of Trace A	Pos Peak
Limit	
Limit1	Off, Limit Upper, 0 dBm
Limit2	Off, Limit Lower, -100 dBm
Test	Stop
Fail to stop	Off
Buzzer	Off
X Axis	Freq
Demod	
Demod Mode	Off
Earphone	Off
Volume	6
Demod Time	5.00 s
Marker	
Select Marker	1
Select Trace	A
Marker Type	Normal
Relative To	2
Marker Table	Off
Marker Fn	
Select Marker	1
Marker Fn	Off
N dB BW	-3 dB
Read Out	Frequency
Freq Counter	Off
Peak	
Cont Peak	Off
Peak Table	Off
Peak Threshold	-140 dBm
Peak Excursion	15 dB
Peak Type	Max
Sort By	Ampt
Mode	

Mode	Spec Analyzer
Measure	
Meas Type	Off
Measure Setup	
Channel Power	
Center Freq	750 MHz
Integration BW	2 MHz
Span	1.5 GHz
ACPR	
Center Freq	750 MHz
Main Channel	1 MHz
Adjacent Chn	1 MHz
Adj Chn Space	3 MHz
Occupied BW	
Method	%
dBc	26
%	99
T-Power	
Center Freq	750 MHz
Start Line	0 s
Stop Line	60.6 us
Spectrum Monitor	
Spectrogram	Run
CNR	
Carrier BW	3 MHz
Noise BW	3 MHz
Freq Offset	3 MHz
Harmonics	
Fundamental	Auto
Freq Step	Auto
Harmonic Num	10
Select Harmonic	All
System**	
Language	English
Power On	Def
Preset	Def
Power on Line	Disable
IP Config	DHCP
Auto Cal	Close
Time Date	On
Set Format	ymd

Display**	
Grid Brightness	30%
Screenshot	Normal
Touch	On
Touch Assistant	On
Power Saving	Always On
Annotation	Off
Display Line	Off, 0 dBm

Table 4-4 Default Preset of Modulation Analyzer Mode

Parameter	Default
Measure	
Meas Type	QAM
Analog Modulation	
Frequency	
Center Freq	100 MHz
Freq Step	10 kHz
Span	
Span	13.08083 MHz
Amplitude	
Attenuator	Auto, 20 dB
Preamp	Off
BW	
EQBW	100 kHz
Window	Flat Top
Sweep	
Sweep	Continue
Trig	
Trigger Type	Free Run
Video Trigger	0 dBm
External Trigger	Rising
Trace	
Select Trace	A
Num of Trace	2
Layout	Grid 1,2
Data of Trace A	Time
Data of Trace B	Spec
Marker	
Select Trace	A
Select Marker	1
Marker Type	Normal

Relative To	2
Couple	Off
Meas Setup	
IFBQ	Auto, 1.2 MHz
EqLPF	Auto, 200 kHz
Average	Off
Avg Times	10
Digital Modulation	
Frequency	
Center Freq	100 MHz
Freq Step	10 kHz
Span	
Span	31.25 kHz
Amplitude	
Attenuator	Auto, 20 dB
Preamp	Off
Ref Level of Trace A	1.5
Scale/Div of Trace A	0.3
Ref Level of Trace B	0 dBm
Scale/Div of Trace B	10 dB
Ref Level of Trace D	1.5
Scale/Div of Trace D	0.3
BW	
EQBW	100 kHz
Window	Flat Top
Sweep	
Sweep	Continue
Trig	
Trigger Type	Free Run
Video Trigger	0 dBm
External Trigger	Rising
Trace	
Select Trace	A
Num of Trace	4
Layout	Grid 2x2
Data of Trace A	IQ Meas Time
Format of Trace A	Constellation
Data of Trace B	Spec
Format of Trace B	Log Mag
Data of Trace C	Syms/Errs
Format of Trace C	Log Mag

Data of Trace D	IQ Meas Time
Format of Trace D	I-Eye
Properties	
Eye Length	2
Symbol Table	Hex
Marker	
Select Trace	A
Select Marker	1
Marker Type	Normal
Relative To	2
Couple	Off
Meas Setup	
Format	16QAM
Symbol Rate	10 ksps
Points/Symbol	4
Meas Length	128
Filter Setup	
Meas Filter	Sqrt Nyquist
Ref Filter	Nyquist
Alpha/BT	0.35
Filter Length	64
Statistic	
Statistic	Off
Average	Off
Avg Times	10

4.4.2 Couple

Set related parameters according to the coupling relationship.

Auto all: Set Related parameters automatically according to the coupling relationship.

1. Freq step

Freq step has a coupling relationship with RBW at the zero span, when in none-zero mode, Freq step have coupling relationship with Span. please refer to the introduction of the "Freq Step".

2. Attenuation

Input attenuation has coupling relationship with Ref Level and the preamp. Please refer to introduction of "amplitude".

3. RBW

RBW has a coupling relationship with the span. Please refer to the introduction of the "Resolution Bandwidth".

4. VBW

VBW has a coupling relationship with the span. Please refer to the introduction of "VBW".

5. Sweep time

Sweep time has a coupling relationship with RBW, VBW and span. Please refer to the introduction of "Sweep Time".

6. Mode Couple

Some of the basic parameters are allowed to be set up in coupled operation between different modes. If the Center Freq is set to on in one mode, it applies to all other modes that support center freq setting so that you can switch between any of these modes while center freq will be unchanged. When press All Off, all of the mode couple switches are set to off.

4.4.3 Help

After pressing **Help**, press any key to show help information. Press **Help** second time to close help information.

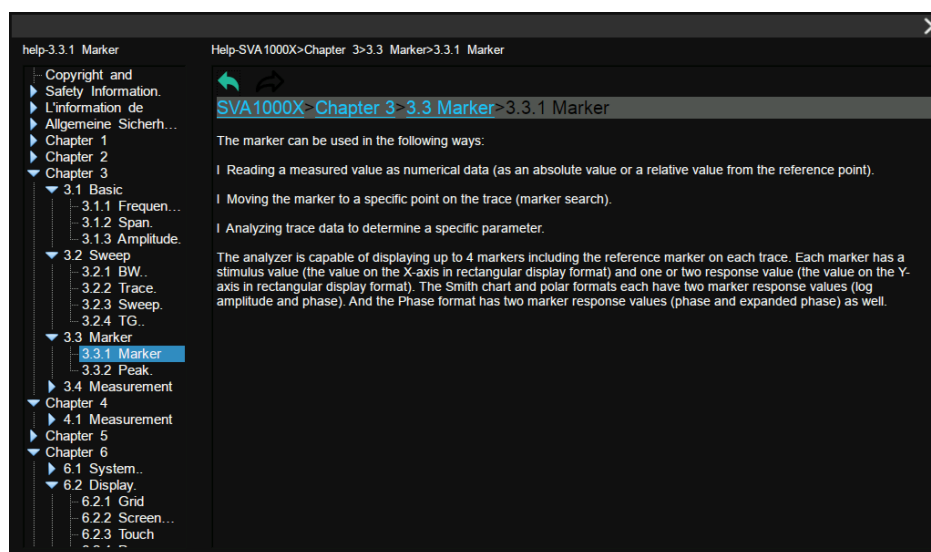

Figure 4-8 Help

4.4.4 Save

Quickly save a file, according to **File->'Save Type'** settings.

By default, pressing **Save** will save screenshots in .PNG format.

If there is an external memory, it will be saved to the external memory first.

Chapter 5 Programming Overview

The analyzer features LAN, USB Device, and SIGLENT GPIB_USB module interfaces. By using a computer with these interfaces, and a suitable programming language (and/or NI-VISA software), users can remotely control the analyzer based on SCPI (Standard Commands for Programmable Instruments) command set, LabView and IVI (Interchangeable Virtual Instrument), to interoperate with other programmable instruments.

This chapter introduces how to build communication between the analyzer and a controller computer with these interfaces.

5.1 Remotely Operating the Analyzer

The analyzer provides both the USB and LAN connection which allows you to set up a remote operation environment with a controller computer. A controller computer could be a personal computer (PC) or a minicomputer. Some intelligent instruments also function as controllers.

5.1.1 USB: Connecting the Analyzer via the USB Device port

Refer to the following steps to finish the connection via USB-Device:

1. Install NI-VISA on your PC for USB-TMC driver.
2. Connect the analyzer USB Device port to a PC with a USB A-B cable.
3. Switch on the analyzer



Figure 5-1 USB Device

The analyzer will be detected automatically as a new USB hardware.

5.1.2 LAN: Connecting the Analyzer via the LAN port

Refer to the following steps to finish the connection via LAN:

1. Install NI-VISA on your PC for VXI driver. Or without NI-VISA, using socket or telnet in your PC's Operating System.
2. Connect the analyzer to PC or the local area network with a LAN cable
3. Switch on the analyzer



Figure 5-2 LAN

4. Press button on the front panel **System** → Interface → LAN to enter the LAN Config function menu.
5. Select the IP Config between Static and DHCP
 - ◆ DHCP: the DHCP server in the current network will assign the network parameters automatically (IP address, subnet mask, gate way) for the analyzer.
 - ◆ Static: you can set the IP address, subnet mask, gate way manually. Press Apply.

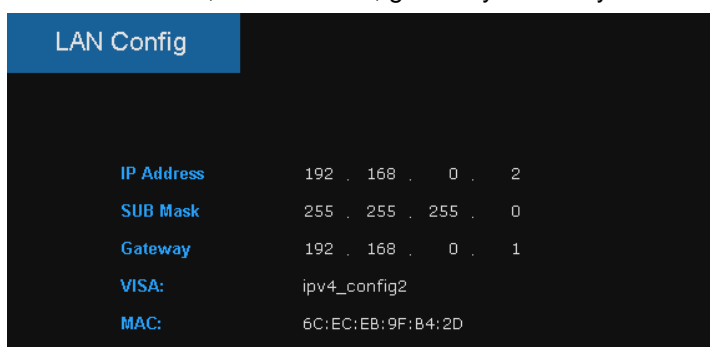

Figure 5-3 LAN Config

The analyzer will be detected automatically or manually as a new LAN point.

5.1.3 GPIB: Connecting the Analyzer via the USB-Host port

Refer to the following steps to finish the connection via USB:

1. Install NI-VISA on your PC for GPIB driver.
2. Connect the analyzer USB Host port to a PC's GPIB card port, with SIGLENT USB-GPIB adaptor.
3. Switch on the analyzer



Figure 5-4 SIGLENT USB-GPIB Adaptor

4. Press button on the front panel **System** → Interface → GPIB to enter the GPIB number.
The analyzer will be detected automatically as a new GPIB point.

5.2 Build Communication

5.2.1 Build Communication Using VISA

NI-VISA includes a Run-Time Engine version and a Full version. The Run-Time Engine version provides NI device drivers such as USB-TMC, VXI, GPIB, etc. The full version includes the Run-Time Engine and a software tool named NI MAX that provides a user interface to control the device.

You can get NI-VISA full version from:

<http://www.ni.com/download/>.

After download you can follow the steps below to install it:

1. Double click the visa_full.exe, dialog shown as below:



2. Click Unzip, the installation process will automatically launch after unzipping files. If your computer needs to install .NET Framework 4, its setup process will auto start.



3. The NI-VISA installing dialog is shown above. Click Next to start the installation process.

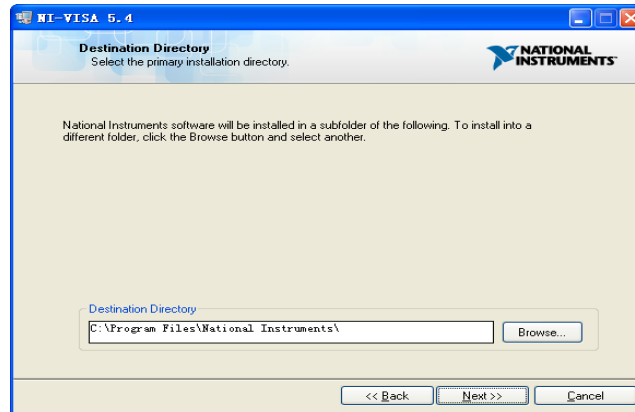

- Set the install path, default path is “C:\Program Files\National Instruments\”, you can change it. Click Next, dialog shown as above.

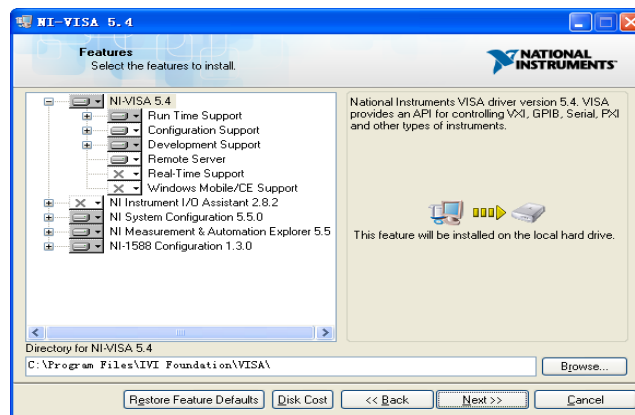

- Click Next twice, in the License Agreement dialog, select the “I accept the above 2 License Agreement(s).”, and click Next, dialog shown as below:

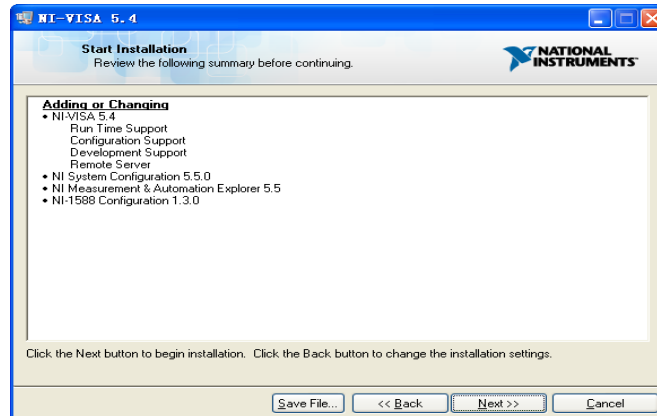

- Click Next to run installation.

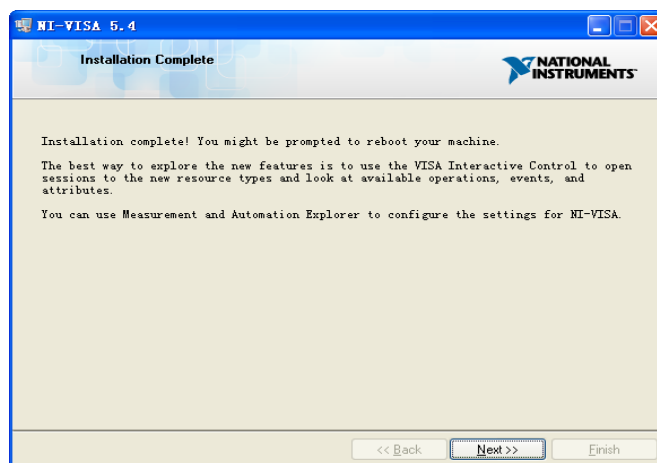

Now the installation is complete, reboot your PC.

5.2.2 Build Communication Using Sockets/Telnet

Through the LAN interface, VXI-11, Sockets and Telnet protocols can be used to communicate with the analyzer. VXI-11 is provided in NI-VISA, while Sockets and Telnet are commonly included in PC's OS initially.

Socket LAN is a method used to communicate with the analyzer over the LAN interface using the Transmission Control Protocol/Internet Protocol (TCP/IP). A socket is a fundamental technology used for computer networking and allows applications to communicate using standard mechanisms built into network hardware and operating systems. The method accesses a port on the analyzer from which bidirectional communication with a network computer can be established.

Before you can use sockets LAN, you must select the analyzer's sockets port number to use:

- ◆ **Standard mode:** Available on port 5025. Use this port for programming.
- ◆ **Telnet mode:** The telnet SCPI service is available on port 5024.

5.3 Remote Control Capabilities

5.3.1 User-defined Programming

Users can use SCPI commands to program and control the analyzer. For details, refer to the introductions in “Programming Examples”.

5.3.2 Send SCPI Commands via NI MAX

Users can control the analyzer remotely by sending SCPI commands via NI-MAX software. NI_MAX is National Instruments Measurement and Automation Explorer. It is an executable program that enables easy communication to troubleshoot issues with instrumentation.

5.3.2.1 Using USB

Run NI MAX software.

1. Click “Device and interface” at the upper left corner of the software;
2. Find the “USBTMC” device symbol

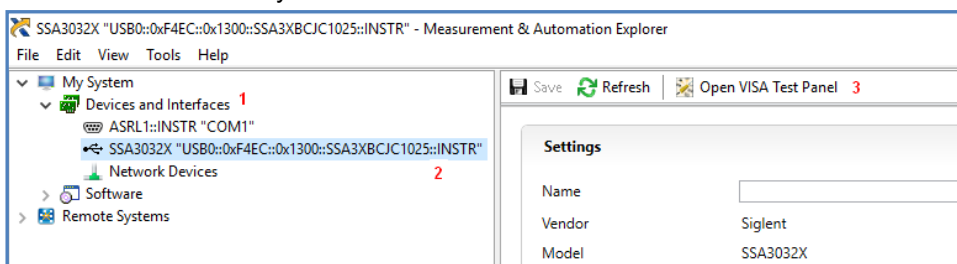

3. Click “Open VISA Test Panel” option button, then the following interface will appear.
4. Click the “Input/Output” option button and click the “Query” option button in order to view the operation information.

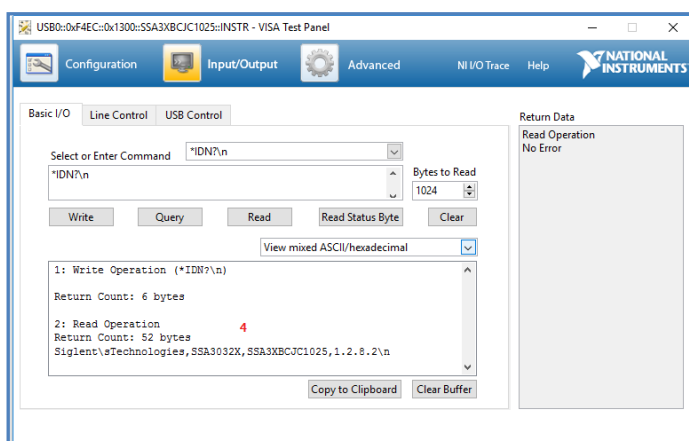

Note: The “*IDN?” command (known as the Identification Query) returns the instrument manufacturer, instrument model, serial number, and other identification information.

5.3.2.2 Using LAN

Select “Add Network Device”, and select “VISA TCP/IP Resource” as shown:

Run NI MAX software.

1. Click “Device and interface” at the upper left corner of the software;
2. Find the “Network Devices” symbol, click “Add Network Devices”;

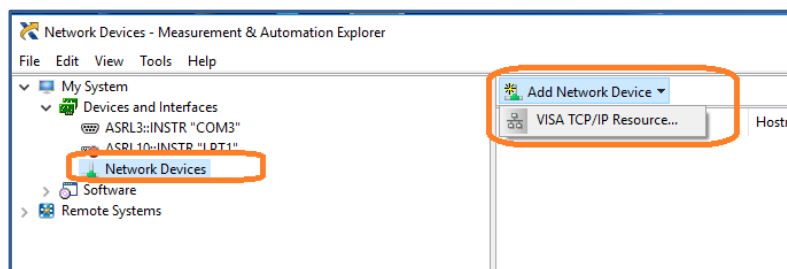

1. Select Manual Entry of LAN instrument, select Next, and enter the IP address as shown. Click Finish to establish the connection:

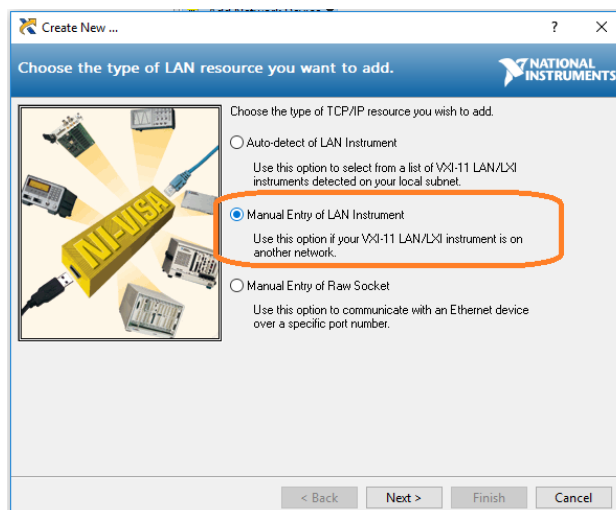

Note: Leave the LAN Device Name BLANK or the connection will fail.

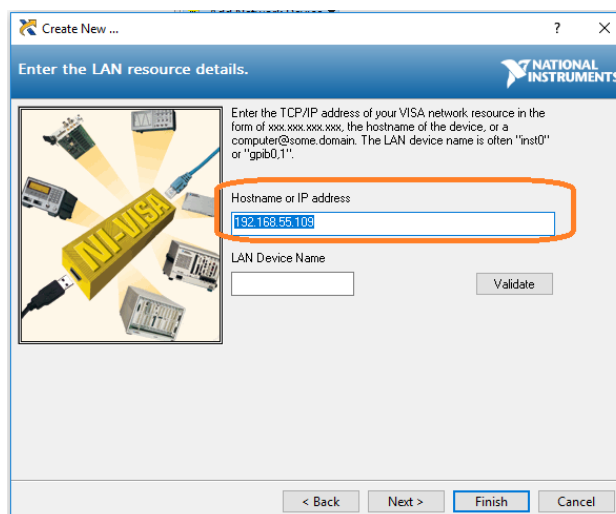

2. After a brief scan, the connection should be shown under Network Devices:

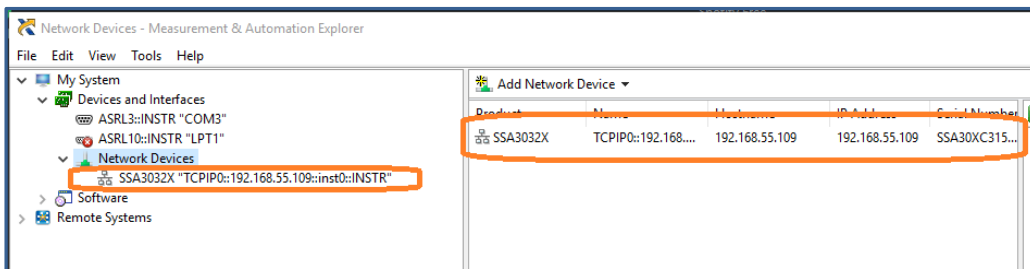

3. Right-click on the product and select Open NI-VISA Test Panel:

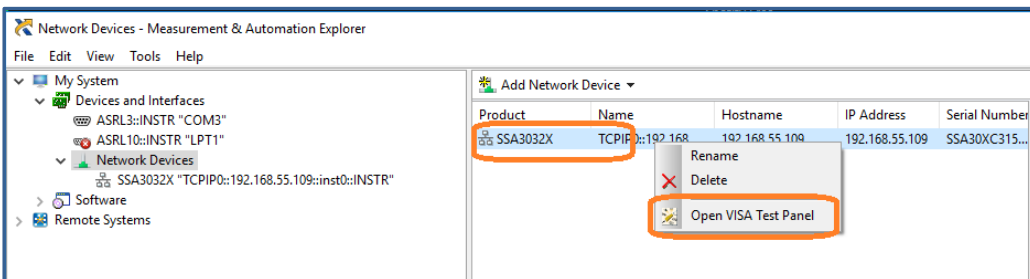

4. Click “Input/Output” option button and click “Query” option button. If everything is OK, you will see the Read operation information returned as shown below.

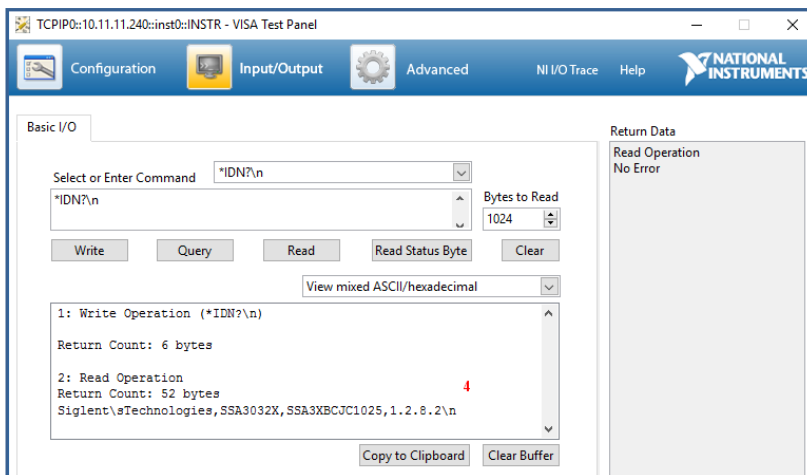

5.3.3 Easy Spectrum Software

Users can control the analyzer remotely by Easy Spectrum. PC software Easy Spectrum is an easy-to-use, PC-Windows-based remote control tool for Siglent’s analyzer. You can download it from Siglent’s website. To connect the analyzer via the USB/LAN port to a PC, you need install the NI VISA first.

It is able to be used as:

- ◆ A monitor to display and control the trace scans simultaneously with the analyzer;
- ◆ A file maker to get user defined Limit/Correction files, and load them to the analyzer;
- ◆ An EMI receiver perform EMI Pre-compliance test including pre-scan, peak search, final scan and report generating.

For the further description of the software, please refer to the online help embedded in this software.

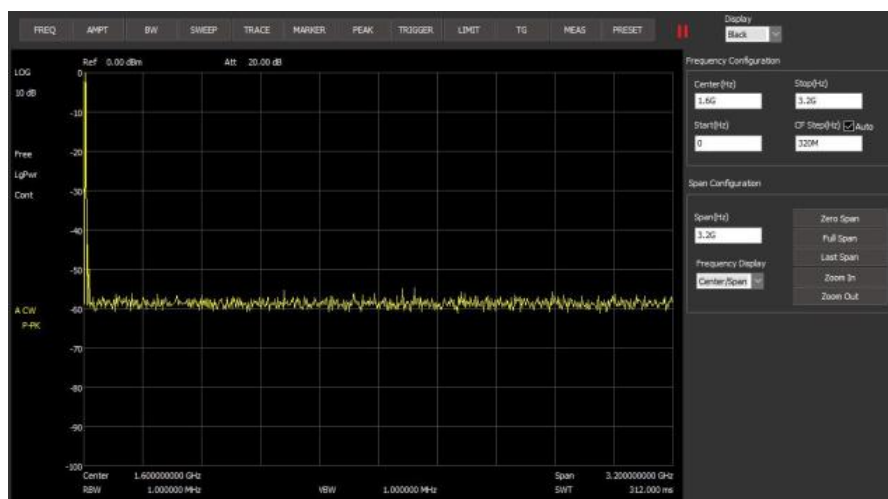

5.3.1 Web Control

With the embedded web server, the analyzer can be controlled through LAN from a web browser* on PC and mobile terminals, without any extra driver be installed. This provides remote controlling and monitoring capabilities. Screenshot and firmware update are also supported.

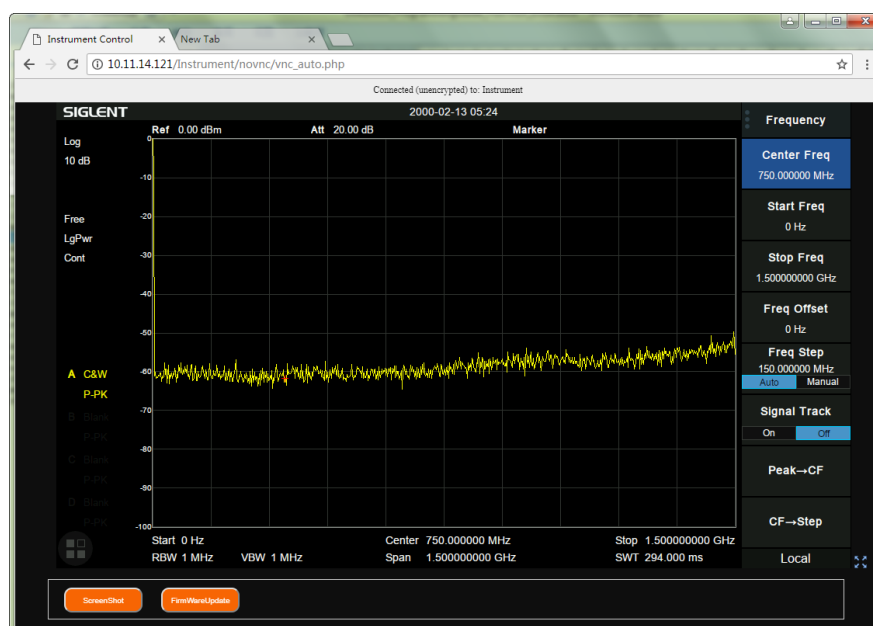

*Web browser with HTML5 supported like Google Chrome or Firefox are recommended.

Chapter 6 Service and Support

6.1 Service Summary

SIGLENT warrants that the products that it manufactures and sells will be free from defects in materials and workmanship for a period of three years (accessories for a period of one year) from the date of shipment from an authorized Siglent distributor. If the product proves defective within the respective period, **SIGLENT** will provide repair or replacement as described in the complete warranty statement. To arrange for service or obtain a copy of the complete warranty statement, please contact your nearest Siglent sales and service office. Except as provided in this summary or the applicable warranty statement, **SIGLENT** makes no warranty of any kind, express or implied, including without limitation the implied warranties of merchantability and fitness for a particular purpose. In no event shall **SIGLENT** be liable for indirect, special or consequential damages.

6.2 Troubleshooting

Before calling **SIGLENT**, or returning an analyzer for service, perform the quick checks listed below. This check may eliminate the problem.

If the problem remains still, please contact **SIGLENT** and provide your device information in the back of the analyzer.

1. The Power Switch is still dark after power on:

- (1) Check that the power is correct / working.
- (2) Check the power cord has been connected correctly
- (3) Check the power fuse. If a new fuse needs to be installed, please use a specified fuse.

2. The analyzer's screen is still dark (no display) after power on:

- (1) Check whether the fan is running while the screen is dark, maybe the LCD cable is loose?
- (2) Check whether the fan is not running while screen is dark, maybe it has failed to start up?

Do not disassemble the instrument by yourself and contact **SIGLENT**.

3. The key is unresponsive or gives a wrong response:

- (1) Press all the keys at the front panel to check if all of them are normal after power on.
- (2) Press **System** ->**Self Test** ->**Key Test** to check if all the keys are working properly.
- (3) If a key is not working, the numeric keyboard connection might be loose or the numeric keyboard is broken.

Do not disassemble the instrument by yourself and contact **SIGLENT**.

4. The spectrum lines on the screen do not update for a long period of time:

- (1) Check whether the screen is locked; if so, press **Esc** to unlock it.
- (2) Verify whether all the trigger conditions have been met and whether there is a valid trigger signal inputting.
- (3) Check whether the analyzer is in single sweep.
- (4) Check whether the current sweep time is too long.

5. Wrong measurement results or poor precision:

To calculate the system errors and check the measurement results and precision, refer to the introductions in “**Specifications**”. To reach these specifications, please:

- (1) Check whether all the external devices are successfully connected and are working normally.
- (2) Get some knowledge of the signal under measurement and set appropriate instrument parameters.
- (3) Make measurements under proper conditions; for example, warm-up the instrument appropriately and operate the instrument under the specified environment temperature.
- (4) Calibrate the instrument regularly to reduce or avoid errors that might occur over time.

If you need a specific calibration after the stated calibration period, contact **SIGLENT** or get paid service from authorized measurement agencies.

6. System Messages:

The instrument may display prompt messages, error messages or state messages according to the current working status. These messages are displayed to help you to use the instrument correctly rather than instrument failures.

#	User system message	Message on screen
System message description(1~199)		
1	SWT_OOR	Sweep time out of range
2	RBW_OOR	RBW out of range
19	PEAK_UNFOUND	No peak found, please change the search config
20	IMD_FREQ_OOR	Frequency of intermodulation products is out of range
21	AUTO_FAIL	No peak found
22	EXT_REF_PLUG_IN	EXT ref plug in
23	EXT_REF_PLUG_OUT	EXT ref plug out
150	LAN_PLUG_IN	Ethernet cable plug in
151	LAN_PLUG_OUT	Ethernet cable plug out
152	IP_CONFLICT	IP address conflict
153	IP_INVALID	IP address invalid
154	NETM_INVALID	Netmask address invalid
155	GWAY_INVALID	Gateway address invalid
Device error(600~799)		
605	LIC_INVALID	License invalid
606	ADC_ERROR	Warning, ADC overload

6.3 Contact Us

China:

SIGLENT TECHNOLOGIES CO., LTD.

Add: Bldg No.4 & No.5, Antongda Industrial Zone, 3rd Liuxian Road, Bao'an District,
Shenzhen, 518101, China.

Tel: + 86 755 3661 5186

Fax: + 86 755 3359 1582

Email: sales@siglent.com;

Website: <http://www.siglent.com/ens/>

USA:

SIGLENT Technologies America, Inc

6557 Cochran Rd Solon, Ohio 44139

Tel: 440-398-5800

Toll Free: 877-515-5551

Fax: 440-399-1211

Email: info@siglent.com

Website: www.siglentamerica.com

Europe:

SIGLENT TECHNOLOGIES EUROPE GmbH

ADD: Liebigstrasse 2-20, Gebaeude 14, 22113 Hamburg Germany

Tel: +49(0)-819-95946

Fax: +49(0)-819-95947

Email: info-eu@siglent.com

Website: www.siglenteu.com