

ASSEMBLY GUIDE (REV. 2)

WAVE2 OSCILLOSCOPE DIY KIT

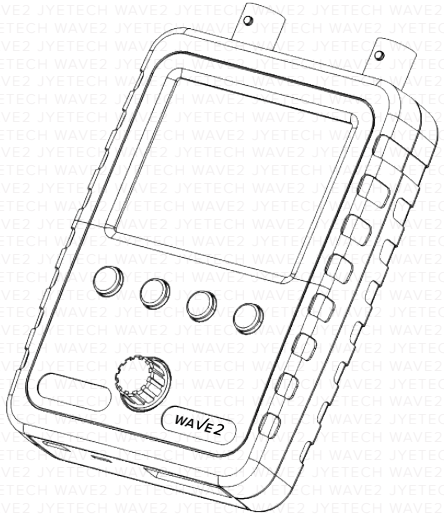

1 Getting Started

TEST THE MAIN BOARD

- 1 Connect the USB Cable to the Micro-USB port on the Main Board and a USB power source.

If prompted to calibrate the touch screen please go to step 9

- 2 Ensure your WAVE2 boots up correctly. When powered on, the LED (D5) will blink 3 times and the screen will turn on.

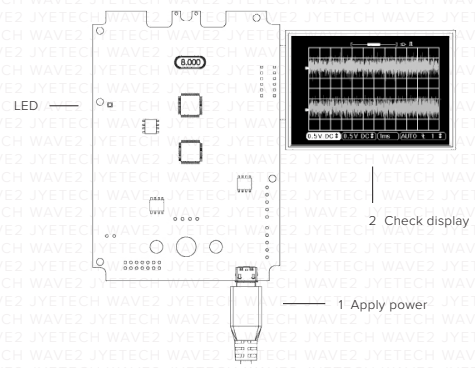

If your WAVE2 does not power up, or powers up with a blank screen, please contact us at support@jytech.com. Do not solder any parts onto the board if you encounter any issues as this will void the warranty.

2 Main Board Assembly

2X1-PIN HEADER

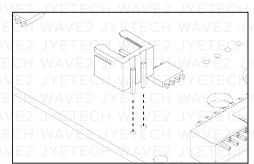

- J6 2x1-pin header

7X2-PIN HEADER

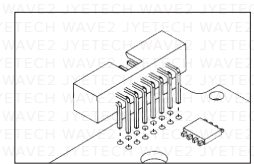

- J5 7x2-pin header

SIGNAL TERMINAL

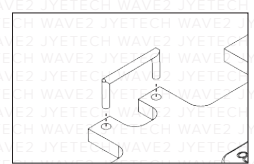

- J8 Wire lead

4X1-PIN HEADER

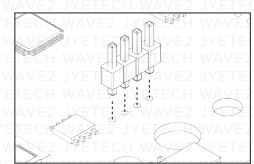

- J2 4x1-pin header

A resistor lead can be used for signal terminal.

MODEL	15801K
PCB VERSION	MAIN: 109-15800-001 ANALOG: 109-15803-00A
FIRMWARE	113-15801-045 OR LATER

REQUIRED TOOLS

- 1 25W - 50W Soldering Iron
- 2 Soldering Wire (Rosin-core Recommended)
- 3 Digital Multimeter
- 4 Screwdriver
 - Phillips #0
 - Slotted #2
- 5 Flush (wire) cutter
- 6 Tweezers
- 7 Micro-USB power cable

Optional Break-out Boards (BOB) Assembly

Two BOB assemblies are provided with your WAVE2. BOB1 is a Battery Charging Regulator and is required if the optional battery is used. BOB2 is a Power Switch board which would enable powering the WAVE2 ON and OFF by pressing down on the Dial. If BOB2 is not installed, the WAVE2 will be powered ON when the power cable is connected, and OFF once removed.

After both are soldered, BOB1 and BOB2 can be enabled by removing the bypass resistors R49 and R50, respectively.

5X1-PIN HEADER (2)

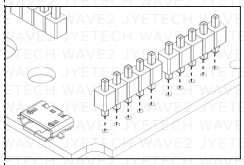

- BOB1 (I18)
- BOB2 (I17)

BOB BOARDS

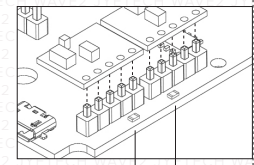

ROTARY ENCODER

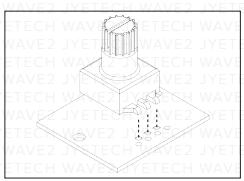

Mount the Rotary Encoder to the PCB (PN: 109-15002-01A).

Ensure the encoder is flush with the PCB and use sufficient solder for a good connection to form.

3 Analog Board Assembly

RESISTORS

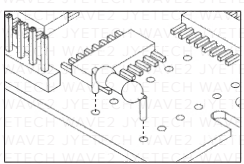

Use a multimeter or a resistor color code to identify the resistor rating.

<input type="checkbox"/> R1, R14	1MΩ
<input type="checkbox"/> R2, R15	51KΩ
<input type="checkbox"/> R3, R16	2KΩ
<input type="checkbox"/> R4, R17	510Ω
<input type="checkbox"/> R5, R11, R18, R24	3KΩ
<input type="checkbox"/> R6, R12, R19, R25	1KΩ
<input type="checkbox"/> R7, R20	820Ω
<input type="checkbox"/> R8, R21	150Ω
<input type="checkbox"/> R9, R22	39Ω
<input type="checkbox"/> R10, R23	10Ω
<input type="checkbox"/> R13, R26	360Ω

BNC CONNECTORS

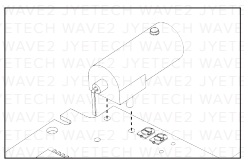

- J1, J2 BNC

The larger BNC pins may require additional solder for a proper connection to be made.

6X2-PIN HEADER

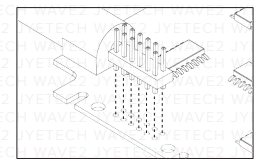

- J3 6x2 pin header

4 Front Module Assembly

- 1 Place the Buttons onto the front screen panel.

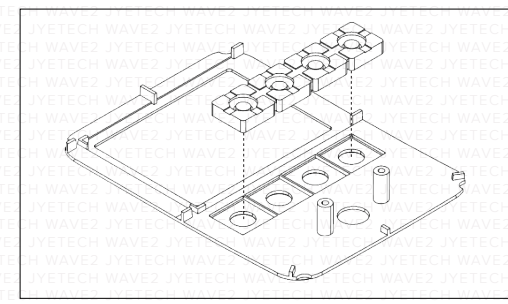

- 2 Align and press the LCD screen onto the screen panel. Fold over the PCB carefully to cover the LCD screen.

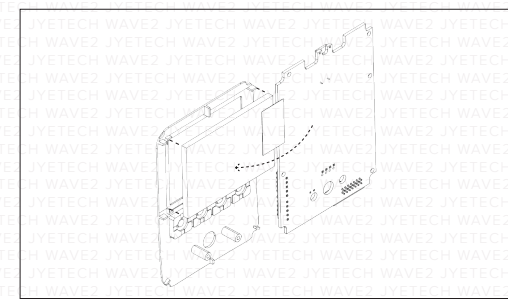

- 3 Mount the Rotary Encoder board on the Main Control Board.

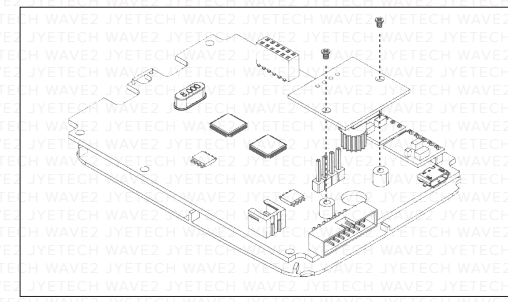

Use the two M2x4 screws to secure the board, Ensure the board is evenly fitted. Solder the board to the 4x1 pins (J2).

After soldering the pins on the Rotary Encoder board, trim the pins for a better fit of all internal components, including the battery.

5 Verify Voltages

- 1 Attach the analog board to the main board by mating J3 on the analog board to J9 on the main board.
- 2 Apply 5V power supply via the micro-USB connector.
- 3 Spot check the voltages on the back of the Analog Board to ensure they measure to the voltages in the chart below.

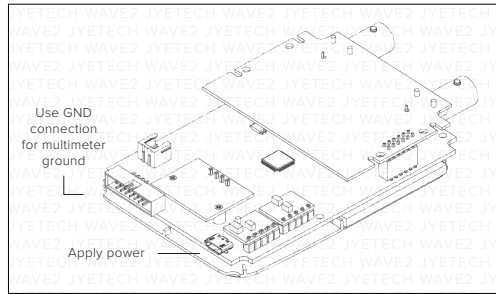

REFERENCE

Measurements applicable for PCB version 109-15803-00A

Test Points	Voltage
VS+	Greater than 7.0V
VS-	Lower than -6.5V
AV1+ / AV2+	+5.0V ± 5%
AV1- / AV2-	-5.0V ± 5%
V11 and V21	0V
V12 and V22	0V
V13 and V23	0V
V14 and V24	+1.65V ± 10%

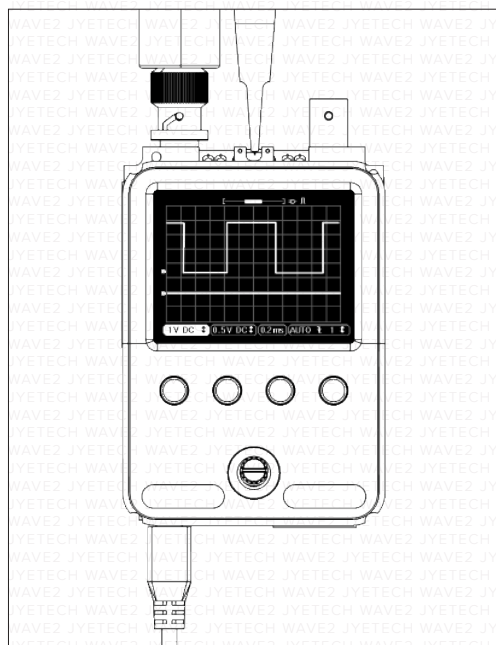

6 Calibration

To ensure you get the best results out of your new WAVE2 Oscilloscope, we recommend calibrating it before first use.

- 1 Start calibration by connecting a BNC Connector to CH1 and the probe to the Test Signal connector. Ensure the probe attenuation is set to x1.
- 2 Set the Voltage Division to 1V and Time Base Division to 0.2ms.
- 3 Use trimmer C3 to adjust the waveform until you get a well defined square wave. Trigger level may need to be adjusted to stabilize the waveform.

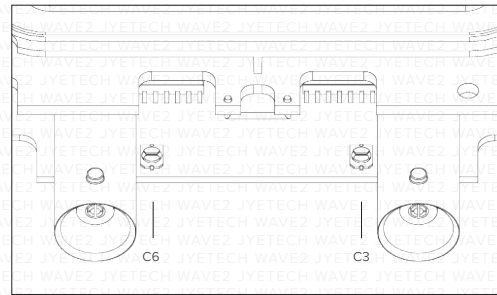

- 4 Repeat steps 1 through 3 for CH2 using trimmer C6.

SUMMARY OF THE SETTINGS DURING CALIBRATION

	Channel 1	Channel 2
	C3	C6
Channel	CH1	CH2
Probe Setting	1X	1X
Test Signal Amplitude	3.3V	3.3V
Voltage Division	1V	1V
Time Base Division	0.2ms	0.2ms
Couple	DC	DC
Trigger Mode	Auto	Auto
Trigger Source	1	2
Trigger Level	Half of Square Wave Amplitude	

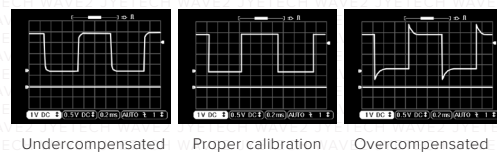

7 Final Assembly

- 1 Slide the BNC Cover onto the Analog Board. Make sure the Test Signal opening is positioned as shown in the diagram below:

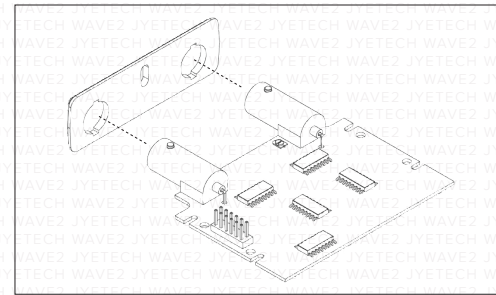

- 2 Insert the assembled Analog Board onto the Back Enclosure Panel and secure the board using four M2x4 screws.

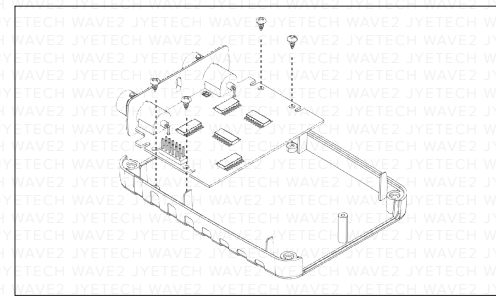

- 3 Install the battery (if provided) below the Analog Board as shown in the following diagram:

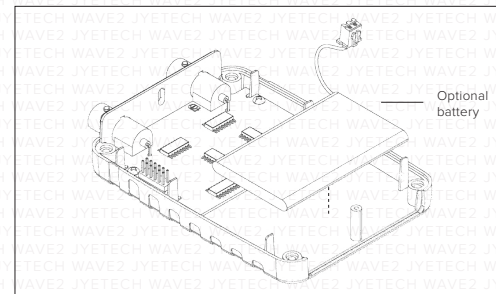

- 4 Slide the Bottom Cover into the Back Enclosure, ensuring the micro-USB and Auxiliary Port are positioned as shown in the following diagram:

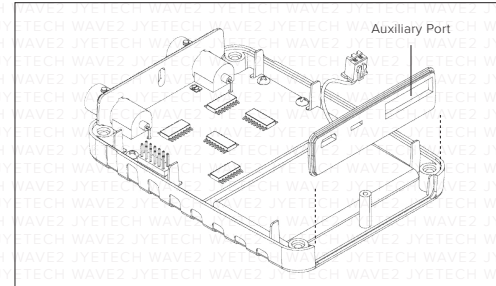

- 5 Connect the battery to the Battery connector (J6) on the Front Module Assembly.
- 6 Cover the Analog Board Assembly with the Front Module Assembly while ensuring the 6x2-pin header connectors (J3 and J9) match correctly.

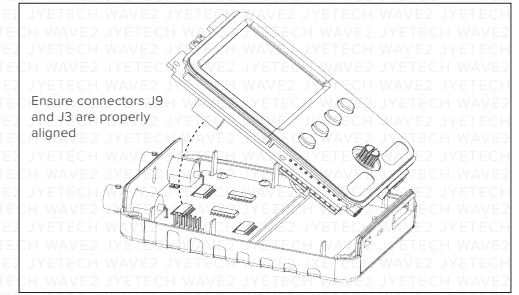

- 7 Finally, place the Top Cover and secure it using four M2x6 screws. Attach the Dial over the Rotary Encoder to complete the assembly.

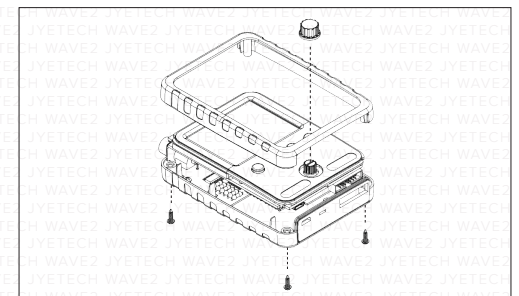

8 Quick Test

- 1 Disconnect all probes and power up the oscilloscope by either pressing down the Dial (if BOB2 has been installed), or by simply plugging in the power (if BOB2 has not been installed or enabled) - For more information on BOB2 see section 2.
- 2 Once the WAVE2 starts up, press the Dial to enter the Menu and select the "Default" option. This will set all parameters to their default values.
- 3 Enter the menu once again and select "ClrOffset". This will reset the vertical position indicators for CH1 and CH2 to 0V.
- 4 Connect the BNC connectors to both CH1 and CH2 and the probe to the Test Signal to ensure the Square Wave is properly displayed.

9 Touch Screen Calibration

- 1 Press the Dial to power up the unit, followed by "F3" when the WAVE2 splash screen appears.
- 2 During the calibration process, three white crosses will be displayed sequentially. Touch the center of each cross 8 times to calibrate the screen.
- 3 Once the calibration process is complete, a green cross will appear on the screen and it will follow any subsequent touches on the screen to test the calibration results.
- 4 Press the Dial to exit the calibration state and reboot the WAVE2 oscilloscope.