

# NCS210R, NCV210R, NCS211R, NCV211R, NCS213R, NCV213R, NCS214R, NCV214R



ON Semiconductor®

[www.onsemi.com](http://www.onsemi.com)

## Current-Shunt Monitors, Voltage Output, Bidirectional Zero-Drift, Low- or High-Side Current Sensing

The NCS210R, NCS211R, NCS213R and NCS214R are voltage output, current shunt monitors (also called current sense amplifiers) which can measure voltage across shunts at common-mode voltages from  $-0.3\text{ V}$  to  $26\text{ V}$ , independent of supply voltage. The low offset of the zero-drift architecture enables current sensing across the shunt with maximum voltage drop as low as  $10\text{ mV}$  full-scale. These devices can operate from a single  $+2.2\text{ V}$  to  $+26\text{ V}$  power supply, drawing a maximum of  $80\text{ }\mu\text{A}$  of supply current, and are specified over the extended operating temperature range ( $-40^\circ\text{C}$  to  $+125^\circ\text{C}$ ). Available in the SC70-6 and UQFN10 packages.

### Features

- Wide Common Mode Input Range:  $-0.3\text{ V}$  to  $26\text{ V}$
- Supply Voltage Range:  $2.2\text{ V}$  to  $26\text{ V}$
- Low Offset Voltage:  $\pm 35\text{ }\mu\text{V}$  max
- Low Offset Drift:  $0.5\text{ }\mu\text{V}/^\circ\text{C}$
- Low Gain Error:  $1\%$  max
- Low Gain Error Drift:  $10\text{ ppm}/^\circ\text{C}$  max
- Rail-to-Rail Output Capability
- Low Current Consumption:  $40\text{ }\mu\text{A}$  typ,  $80\text{ }\mu\text{A}$  max
- NCV Prefix for Automotive and Other Applications Requiring Unique Site Qualified and PPAP Capable

### Typical Applications

- Current Sensing (High-Side/Low-Side)
- Automotive
- Telecom
- Power Management
- Battery Charging and Discharging



UQFN10  
MU SUFFIX  
CASE 488AT



SC70-6  
SQ SUFFIX  
CASE 419B

### MARKING DIAGRAM



XXX = Specific Device Code  
M = Date Code  
■ = Pb-Free Package  
(Note: Microdot may be in either location)

### PIN CONNECTIONS



\*NC denotes no internal connection. These pins can be left floating or connected to any voltage between  $V_S$  and GND.

### ORDERING INFORMATION

See detailed ordering, marking and shipping information on page 2 of this data sheet.

**NCS210R, NCV210R, NCS211R, NCV211R, NCS213R, NCV213R, NCS214R, NCV214R**



$$V_{OUT} = (I_{LOAD} \times R_{SHUNT})GAIN + V_{REF}$$

**Figure 1. Example Application Schematic of High-Side Current Sensing**

**ORDERING INFORMATION**

| Device        | Gain | R3 and R4 | R1 and R2 | Marking | Package | Shipping†            |
|---------------|------|-----------|-----------|---------|---------|----------------------|
| NCS210RSQT2G  | 200  | 5 kΩ      | 1 MΩ      | AVY     | SC70-6  | 3000 / Tape and Reel |
| NCV210RSQT2G* | 200  | 5 kΩ      | 1 MΩ      | AVY     | SC70-6  | 3000 / Tape and Reel |
| NCS210RMUTAG  | 200  | 5 kΩ      | 1 MΩ      | CP      | UQFN10  | 3000 / Tape and Reel |
| NCS211RSQT2G  | 500  | 2 kΩ      | 1 MΩ      | AVZ     | SC70-6  | 3000 / Tape and Reel |
| NCV211RSQT2G* | 500  | 2 kΩ      | 1 MΩ      | AVZ     | SC70-6  | 3000 / Tape and Reel |
| NCS213RSQT2G  | 50   | 20 kΩ     | 1 MΩ      | AV3     | SC70-6  | 3000 / Tape and Reel |
| NCV213RSQT2G* | 50   | 20 kΩ     | 1 MΩ      | AV3     | SC70-6  | 3000 / Tape and Reel |
| NCS214RSQT2G  | 100  | 10 kΩ     | 1 MΩ      | AV4     | SC70-6  | 3000 / Tape and Reel |
| NCV214RSQT2G* | 100  | 10 kΩ     | 1 MΩ      | AV4     | SC70-6  | 3000 / Tape and Reel |
| NCS214RMUTAG  | 100  | 10 kΩ     | 1 MΩ      | CR      | UQFN10  | 3000 / Tape and Reel |
| NCS211RMUTAG  | 500  | 2 kΩ      | 1 MΩ      | CM      | UQFN10  | 3000 / Tape and Reel |
| NCS213RMUTAG  | 50   | 20 kΩ     | 1 MΩ      | CQ      | UQFN10  | 3000 / Tape and Reel |

†For information on tape and reel specifications, including part orientation and tape sizes, please refer to our Tape and Reel Packaging Specifications Brochure, BRD8011/D.

\*NCV Prefix for Automotive and Other Applications Requiring Unique Site and Control Change Requirements; AEC-Q100 Qualified and PPAP Capable.

**Table 1. MAXIMUM RATINGS**

| Parameter                                 |  | Symbol             | Value                      | Unit |
|---|--|--------------------|----------------------------|------|
| Supply Voltage (Note 1)                   |  | $V_S$              | +30                        | V    |
| Analog Inputs                             | Differential ( $V_{IN+}$ )–( $V_{IN-}$ ) | $V_{IN+}, V_{IN-}$ | –30 to +30                 | V    |
|   | Common–Mode (Note 2)                     |                    | (GND–0.3) to +30           |      |
| REF Input                                 |  | $V_{REF}$          | (GND–0.3) to ( $V_S$ +0.3) | V    |
| Output (Note 2)                           |  | $V_{OUT}$          | (GND–0.3) to ( $V_S$ +0.3) | V    |
| Input Current into Any Pin (Note 2)       |  |                    | 5                          | mA   |
| Maximum Junction Temperature              |  | $T_{J(max)}$       | +150                       | °C   |
| Storage Temperature Range                 |  | TSTG               | –65 to +150                | °C   |
| ESD Capability, Human Body Model (Note 3) |  | HBM                | ±2000                      | V    |
| Charged Device Model (Note 3)             |  | CDM                | ±2000                      | V    |
| Latch–Up Current (Note 4)                 |  | $I_{LU}$           | 100                        | mA   |

Stresses exceeding those listed in the Maximum Ratings table may damage the device. If any of these limits are exceeded, device functionality should not be assumed, damage may occur and reliability may be affected.

1. Refer to ELECTRICAL CHARACTERISTICS, RECOMMENDED OPERATING RANGES and/or APPLICATION INFORMATION for safe operating parameters.
2. Input voltage at any pin may exceed the voltage shown if current at that pin is limited to 5 mA.
3. This device series incorporates ESD protection and is tested by the following methods:  
 ESD Human Body Model tested per JEDEC standard JS–001–2017 (AEC–Q100–002).  
 ESD Charged Device Model tested per JEDEC standard JS–002–2014 (AEC–Q100–011).
4. Latch–up Current tested per JEDEC standard JESD78E (AEC–Q100–004)

**Table 2. RECOMMENDED OPERATING RANGES**

| Parameter                 | Symbol   | Min  | Typ | Max | Unit |
|---------------------------|----------|------|-----|-----|------|
| Common–mode input voltage | $V_{CM}$ | –0.3 | 12  | 26  | V    |
| Supply Voltage            | $V_S$    | 2.2  | 5   | 26  | V    |
| Ambient Temperature       | $T_A$    | –40  |     | 125 | °C   |

Functional operation above the stresses listed in the Recommended Operating Ranges is not implied. Extended exposure to stresses beyond the Recommended Operating Ranges limits may affect device reliability.

**Table 3. THERMAL CHARACTERISTICS** (Note 5)

| Parameter                                    | Symbol | Value | Unit |
|--|--------|-------|------|
| Thermal Resistance, Junction–to–Air (Note 6) | SC70   | 250   | °C/W |
|  | UQFN10 | 150   |      |

5. Refer to ELECTRICAL CHARACTERISTICS, RECOMMENDED OPERATING RANGES and/or APPLICATION INFORMATION for safe operating parameters.
6. Values based on copper area of 645 mm<sup>2</sup> (or 1 in<sup>2</sup>) of 1 oz copper thickness and FR4 PCB substrate.

# NCS210R, NCV210R, NCS211R, NCV211R, NCS213R, NCV213R, NCS214R, NCV214R

**Table 4. ELECTRICAL CHARACTERISTICS** At  $T_A = +25^\circ\text{C}$ ,  $V_{\text{SENSE}} = V_{\text{IN}+} - V_{\text{IN}-}$ ;

NCS210R, NCS213R and NCS214R:  $V_S = +5\text{ V}$ ,  $V_{\text{IN}+} = 12\text{ V}$ , and  $V_{\text{REF}} = V_S/2$ , unless otherwise noted.

NCS211R:  $V_S = +12\text{ V}$ ,  $V_{\text{IN}+} = 12\text{ V}$ , and  $V_{\text{REF}} = V_S/2$ , unless otherwise noted.

**Boldface** limits apply over the specified temperature range of  $T_A = -40^\circ\text{C}$  to  $125^\circ\text{C}$ , guaranteed by characterization and/or design.

| Symbol              | Parameter                          |                                 | Test Conditions   | Min         | Typ        | Max        | Unit                         |
|---------------------|------------------------------------|---------------------------------|---|-------------|------------|------------|------------------------------|
| <b>INPUT</b>        |                                    |                                 |   |             |            |            |                              |
| $V_{\text{CM}}$     | Common-Mode Input Voltage Range    |                                 |   | <b>-0.3</b> |            | <b>26</b>  | V                            |
| CMRR                | Common-Mode Rejection Ratio        | NCx210R,<br>NCx211R,<br>NCx214R | $V_{\text{IN}+} = 0\text{ V to }+26\text{ V}$ ,<br>$V_{\text{SENSE}} = 0\text{ mV}$<br>$T_A = -40^\circ\text{C to }125^\circ\text{C}$ | <b>105</b>  | 125        |            | dB                           |
|                     |                                    | NCx213R                         |   |             | 120        |            |                              |
| $V_{\text{OS}}$     | Offset Voltage RTI (Note 7)        | NCx210R,<br>NCx211R             | $V_{\text{SENSE}} = 0\text{ mV}$  |             | $\pm 0.55$ | $\pm 35$   | $\mu\text{V}$                |
|                     |                                    | NCx213R                         |   |             | $\pm 5$    | $\pm 100$  |                              |
|                     |                                    | NCx214R                         |   |             | $\pm 1$    | $\pm 60$   |                              |
| $dV_{\text{OS}}/dT$ | RTI vs Temperature (Note 7)        | NCx21xR                         | $V_{\text{SENSE}} = 0\text{ mV}$<br>$T_A = -40^\circ\text{C to }+125^\circ\text{C}$   |             | <b>0.1</b> | <b>0.5</b> | $\mu\text{V}/^\circ\text{C}$ |
| PSRR                | RTI vs Power Supply Ratio (Note 7) |                                 | $V_S = +2.7\text{ V to }+26\text{ V}$ ,<br>$V_{\text{IN}+} = 18\text{ V}$ , $V_{\text{SENSE}} = 0\text{ mV}$                          |             | $\pm 0.1$  | $\pm 10$   | $\mu\text{V}/\text{V}$       |
| $I_{\text{IB}}$     | Input Bias Current                 |                                 | $V_{\text{SENSE}} = 0\text{ mV}$  |             | 39         | 60         | $\mu\text{A}$                |
| $I_{\text{IO}}$     | Input Offset Current               |                                 | $V_{\text{SENSE}} = 0\text{ mV}$  |             | $\pm 0.1$  |            | $\mu\text{A}$                |

## OUTPUT

|       |                           |         |  |  |            |                           |                       |
|-------|---------------------------|---------|--|--|------------|---------------------------|-----------------------|
| G     | Gain                      | NCx210R |  |  | 200        |                           | V/V                   |
|       |                           | NCx211R |  |  | 500        |                           |                       |
|       |                           | NCx213R |  |  | 50         |                           |                       |
|       |                           | NCx214R |  |  | 100        |                           |                       |
| $E_G$ | Gain Error                | NCx21xR | $V_{\text{SENSE}} = -5\text{ mV to }5\text{ mV}$ ,<br>$T_A = -40^\circ\text{C to }125^\circ\text{C}$ |  | $\pm 0.2$  | <b><math>\pm 1</math></b> | %                     |
| $E_G$ | Gain Error vs Temperature | NCx21xR | $T_A = -40^\circ\text{C to }125^\circ\text{C}$   |  | 3          | <b>10</b>                 | ppm/ $^\circ\text{C}$ |
|       | Nonlinearity Error        |         | $V_{\text{SENSE}} = -5\text{ mV to }5\text{ mV}$   |  | $\pm 0.01$ |                           | %                     |
| $C_L$ | Maximum Capacitive Load   |         | No sustained oscillation   |  | 1          |                           | nF                    |

## VOLTAGE OUTPUT

|                 |                                  |  |  |  |                          |   |   |
|-----------------|----------------------------------|--|--|--|--------------------------|---|---|
| $V_{\text{OH}}$ | Swing to $V_S$ Power Supply Rail |  | $R_L = 10\text{ k}\Omega$ to GND<br>$T_A = -40^\circ\text{C to }+125^\circ\text{C}$ (Note 8) |  | $V_S - 0.075$            | <b><math>V_S - 0.2</math></b>             | V |
| $V_{\text{OL}}$ | Swing to GND                     |  | $R_L = 10\text{ k}\Omega$ to GND<br>$T_A = -40^\circ\text{C to }+125^\circ\text{C}$          |  | $V_{\text{GND}} + 0.005$ | <b><math>V_{\text{GND}} + 0.05</math></b> | V |

## FREQUENCY RESPONSE

|    |                                 |         |                                  |  |    |  |                  |
|----|---------------------------------|---------|----------------------------------|--|----|--|------------------|
| BW | Bandwidth ( $f_{-3\text{dB}}$ ) | NCx210R | $C_{\text{LOAD}} = 10\text{ pF}$ |  | 40 |  | kHz              |
|    |                                 | NCx211R |                                  |  | 25 |  |                  |
|    |                                 | NCx213R |                                  |  | 90 |  |                  |
|    |                                 | NCx214R |                                  |  | 60 |  |                  |
| SR | Slew Rate                       |         |                                  |  | 1  |  | V/ $\mu\text{s}$ |

## NOISE

|       |                       |  |                    |  |    |  |  |
|-------|-----------------------|--|--------------------|--|----|--|--|
| $e_n$ | Voltage Noise Density |  | $f = 1\text{ kHz}$ |  | 45 |  |  |
|-------|-----------------------|--|--------------------|--|----|--|--|

## POWER SUPPLY

|       |                                    |  |   |            |    |            |               |
|-------|------------------------------------|--|---|------------|----|------------|---------------|
| $V_S$ | Operating Voltage Range            |  | $T_A = -40^\circ\text{C to }+125^\circ\text{C}$ | <b>2.2</b> |    | <b>26</b>  | V             |
| $I_Q$ | Quiescent Current                  |  | $V_{\text{SENSE}} = 0\text{ mV}$                |            | 40 | 80         | $\mu\text{A}$ |
|       | Quiescent Current over Temperature |  | $T_A = -40^\circ\text{C to }+125^\circ\text{C}$ |            |    | <b>100</b> | $\mu\text{A}$ |

7. RTI = referenced-to-input

8.  $V_S = 5\text{ V}$  for NCx211R

Product parametric performance is indicated in the Electrical Characteristics for the listed test conditions, unless otherwise noted. Product performance may not be indicated by the Electrical Characteristics if operated under different conditions.

**TYPICAL CHARACTERISTICS** ( $T_A = 25^\circ\text{C}$ ,  $V_S = 5\text{ V}$ ,  $V_{IN+} = 12\text{ V}$  and  $V_{REF} = V_S/2$  unless otherwise noted.)  
 (The NCS210R is used for Typical Characteristics)

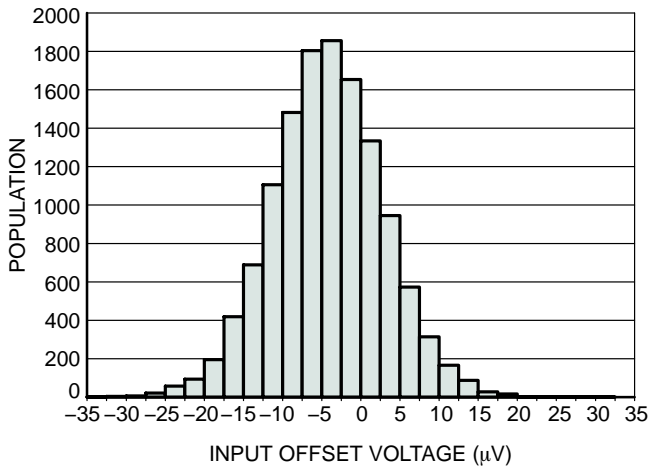

**Figure 2. Input Offset Voltage Production Distribution**

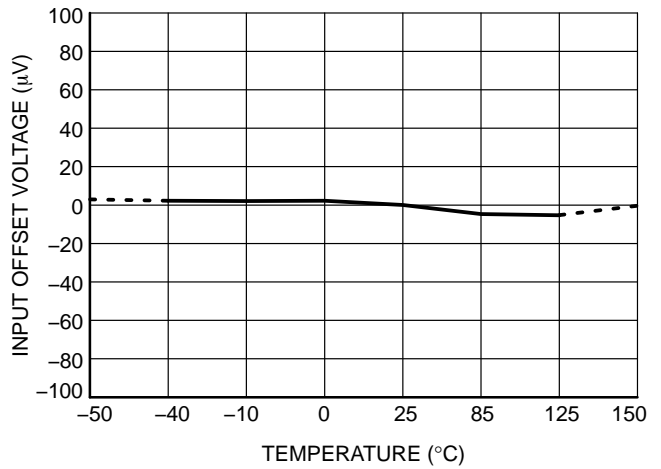

**Figure 3. Input Offset Voltage vs. Temperature**

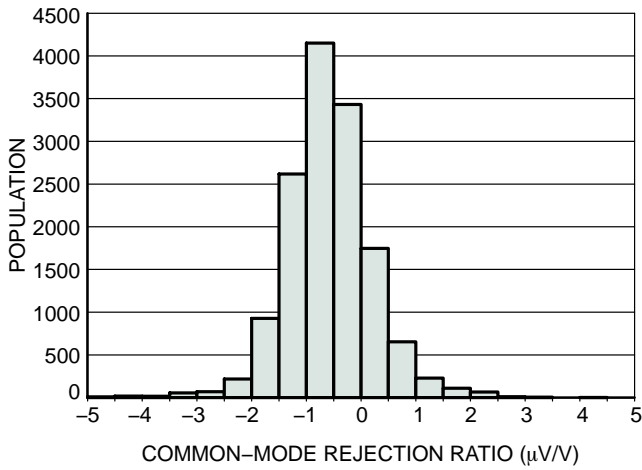

**Figure 4. Common-Mode Rejection Production Distribution**

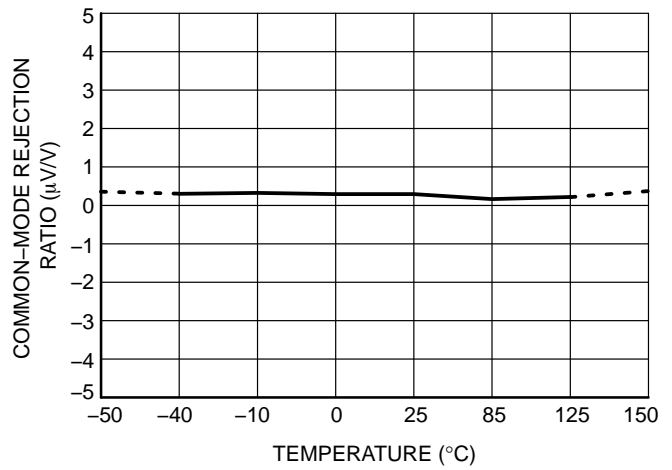

**Figure 5. Common-Mode Rejection Ratio vs. Temperature**

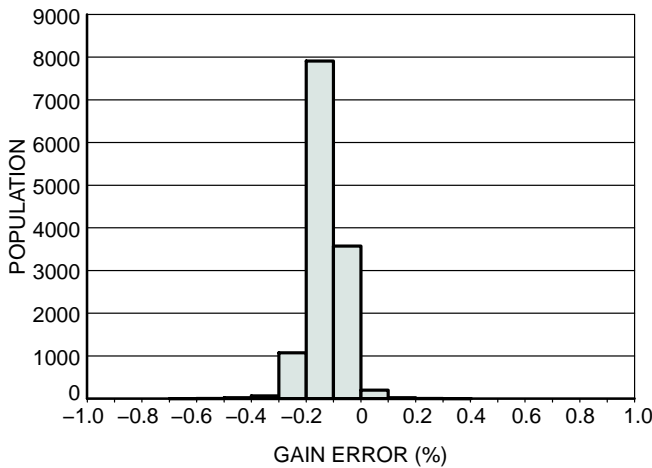

**Figure 6. Gain Error Production Distribution**

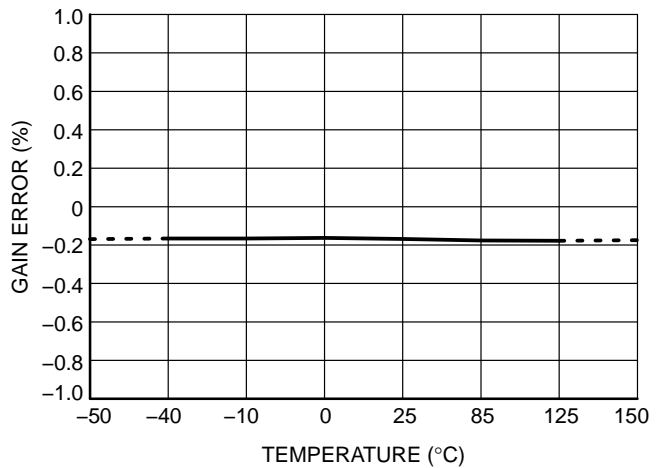

**Figure 7. Gain Error vs. Temperature**

**TYPICAL CHARACTERISTICS** ( $T_A = 25^\circ\text{C}$ ,  $V_S = 5\text{ V}$ ,  $V_{IN+} = 12\text{ V}$  and  $V_{REF} = V_S/2$  unless otherwise noted.)  
 (The NCS210R is used for Typical Characteristics)



Figure 8. Gain vs. Frequency



Figure 9. Power Supply Rejection Ratio vs. Frequency



Figure 10. Common-Mode Rejection Ratio vs. Frequency



Figure 11. Positive Output Voltage Swing vs. Output Current,  $V_S = 2.2\text{ V}$



Figure 12. Negative Output Voltage Swing vs. Output Current,  $V_S = 2.2\text{ V}$

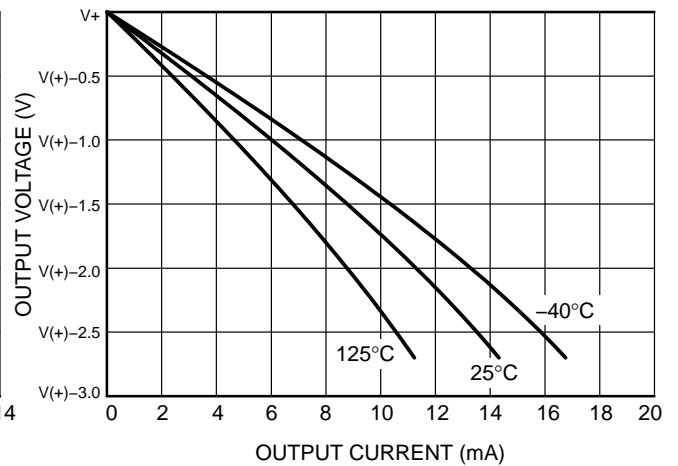
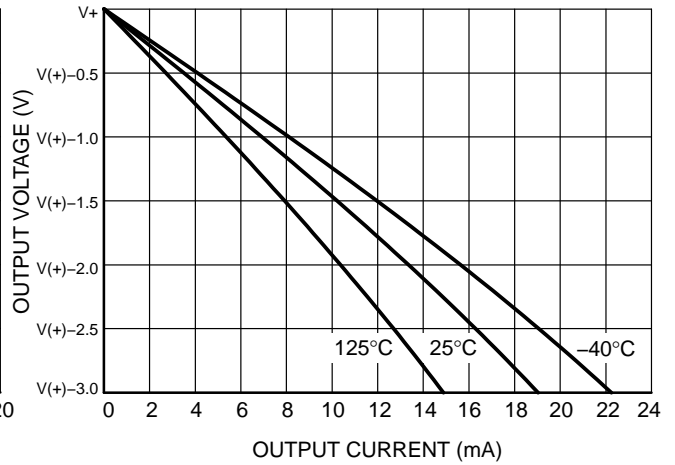

Figure 13. Positive Output Voltage Swing vs. Output Current,  $V_S = 2.7\text{ V}$

**TYPICAL CHARACTERISTICS** ( $T_A = 25^\circ\text{C}$ ,  $V_S = 5\text{ V}$ ,  $V_{IN+} = 12\text{ V}$  and  $V_{REF} = V_S/2$  unless otherwise noted.)  
 (The NCS210R is used for Typical Characteristics)



**Figure 14. Negative Output Voltage Swing vs. Output Current,  $V_S = 2.7\text{ V}$**



**Figure 15. Positive Output Voltage Swing vs. Output Current,  $V_S = 5\text{ V}$**



**Figure 16. Negative Output Voltage Swing vs. Output Current,  $V_S = 5\text{ V}$**

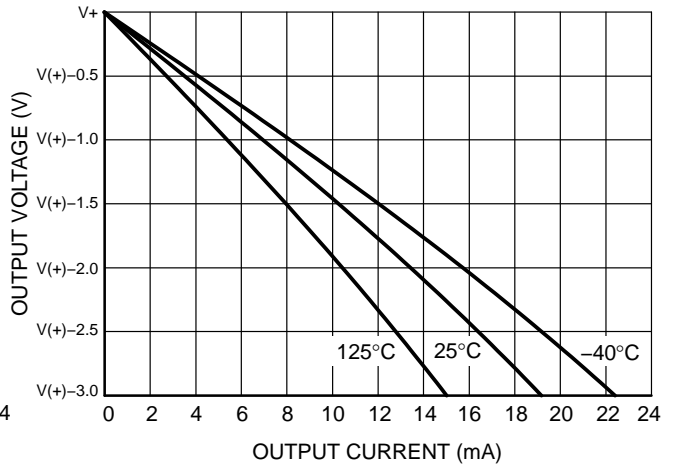

**Figure 17. Positive Output Voltage Swing vs. Output Current,  $V_S = 26\text{ V}$**



**Figure 18. Negative Output Voltage Swing vs. Output Current,  $V_S = 26\text{ V}$**

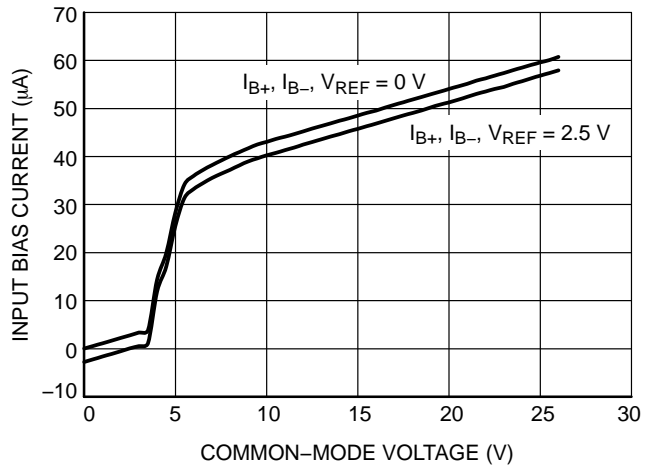

**Figure 19. Input Bias Current vs. Common-Mode Voltage with  $V_S = 5\text{ V}$**

**TYPICAL CHARACTERISTICS** ( $T_A = 25^\circ\text{C}$ ,  $V_S = 5\text{ V}$ ,  $V_{IN+} = 12\text{ V}$  and  $V_{REF} = V_S/2$  unless otherwise noted.)  
 (The NCS210R is used for Typical Characteristics)



**Figure 20. Input Bias Current vs. Common-Mode Voltage with  $V_S = 0\text{ V}$  (Shutdown)**



**Figure 21. Input Bias Current vs. Temperature**



**Figure 22. Quiescent Current vs. Temperature**



**Figure 23. Voltage Noise Density vs. Frequency**

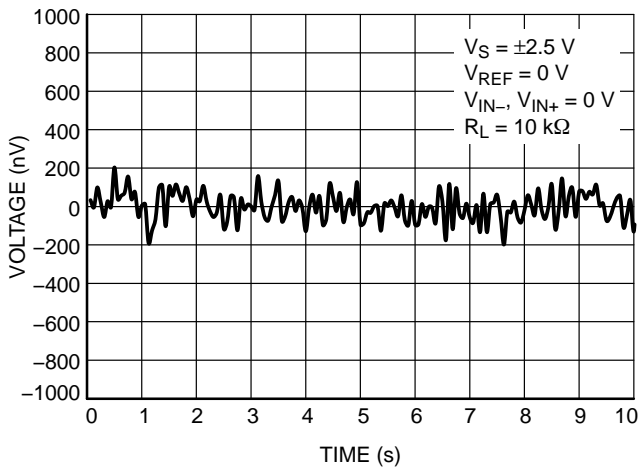

**Figure 24. 0.1 Hz to 10 Hz Voltage Noise (Referred to Input)**

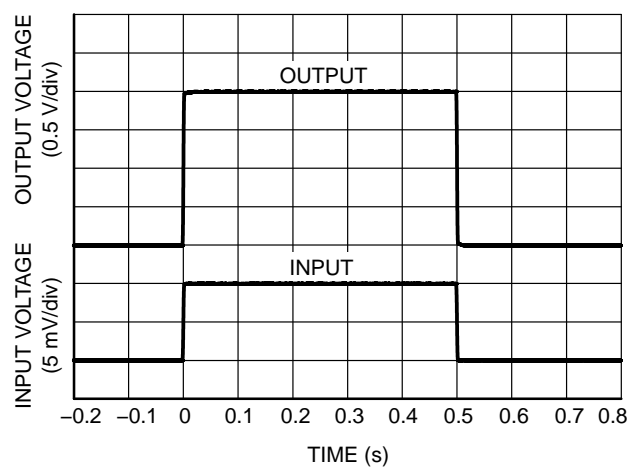

**Figure 25. Step Response (10 mVpp Input Step)**



**TYPICAL CHARACTERISTICS** ( $T_A = 25^\circ\text{C}$ ,  $V_S = 5\text{ V}$ ,  $V_{\text{IN}+} = 12\text{ V}$  and  $V_{\text{REF}} = V_S/2$  unless otherwise noted.)  
 (The NCS210R is used for Typical Characteristics)

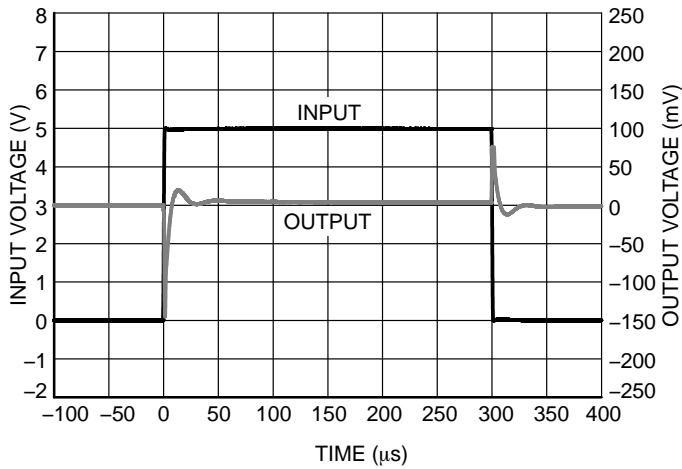

**Figure 26. Common-Mode Voltage Transient Response**

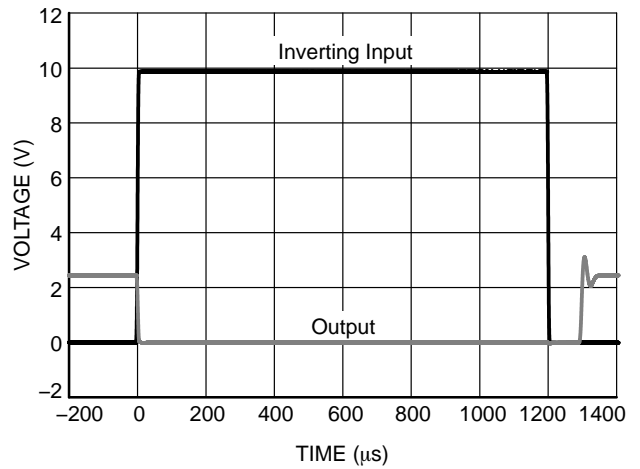

**Figure 27. Inverting Differential Input Overload**



**Figure 28. Noninverting Differential Input Overload**



**Figure 29. Start-Up Response**



**Figure 30. Brownout Recovery**

## Basic Connections

### Current Sensing Techniques

The NCS21xR current-sense amplifiers can be configured for both low-side and high-side current sensing. Low-side sensing appears to have the advantage of being straightforward, inexpensive, and can be implemented with a simple op amp circuit. However, the NCS21xR series of devices provides the full differential input necessary to get accurate shunt connections, while also providing a built-in gain network with precision difficult to obtain with external resistors. While at times the application requires low-side sensing, only high-side sensing can detect a short from the positive supply line to ground. Furthermore, high-side sensing avoids adding resistance to the ground path of the load being measured. The sections below focus primarily on high-side current sensing.

### Unidirectional Operation

In unidirectional current sensing, the current always flows in the same direction. Common applications for unidirectional operation include power supplies and load

current monitoring. Figure 31 shows the NCS21xR circuit implementation for unidirectional operation using high-side current sensing.

Basic connections for unidirectional operation include connecting the load power supply, connecting a current shunt to the differential inputs of the NCS21xR, grounding the REF pin, and providing a power supply for the NCS21xR. The NCS21xR can be connected to the same power supply that it is monitoring current from, or it can be connected to a separate power supply. If it is necessary to detect short circuit current on the load power supply, which may cause the load power supply to sag to near zero volts, a separate power supply must be used on the NCS21xR. When using multiple supplies, there are no restrictions on power supply sequencing.

When no current is flowing through the  $R_{SHUNT}$ , and the REF pin is connected to ground, the NCS21xR output is expected to be within 50 mV of ground. When current is flowing through  $R_{SHUNT}$ , the output will swing positive, up to within 200 mV of the applied supply voltage,  $V_S$ .

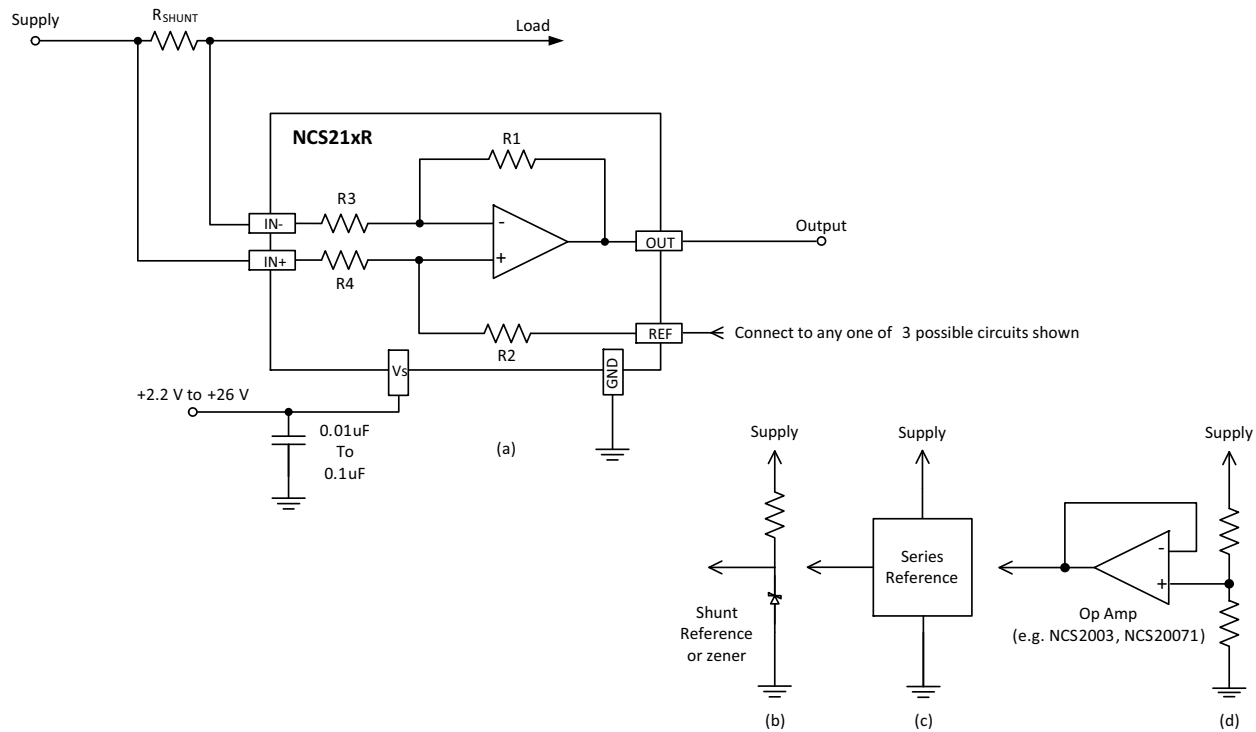

Figure 31. Basic Unidirectional Connection

### Bidirectional Operation

In bidirectional current sensing, the current measurements are taken when current is flowing in both directions. For example, in fuel gauging, the current is measured when the battery is being charged or discharged. Bidirectional operation requires the output to swing both positive and negative around a bias voltage applied to the

REF pin. The voltage applied to the REF pin depends on the application. However, most often it is biased to either half of the supply voltage or to half the value of the measurement system reference. Figure 32 shows bidirectional operation with three different circuit choices that can be connected to the REF pin to provide a voltage reference to the NCS21xR.



**Figure 32. Bidirectional Current Sensing with Three Example Voltage Reference Circuits**

The REF pin must always be connected to a low impedance circuit, such as in the Figure 32(b), (c), and (d). The REF pin can be connected directly to any voltage supply or voltage reference (shunt or series). However, if a resistor divider network is used to provide the reference voltage, a unity gain buffer circuit must be used, as shown in Figure 32(d).

In bidirectional applications, any voltage that exceeds  $V_S + 0.3$  V applied to the REF pin will forward bias an ESD diode between the REF pin and the  $V_S$  pin. Note that this exceeds the Absolute Maximum Ratings for the device.

**Input and Output Filtering**

Filtering at the input or output may be required for several different reasons. In this section we will discuss the main considerations with regards to these filter circuits.

In some applications, the current being measured may be inherently noisy. In the case of a noisy signal, filtering after the output of the current sense amplifier is often simpler, especially where the amplifier output is fed into high impedance circuitry. The amplifier output node provides the greatest freedom when selecting components for the filter and is very straightforward to implement, although it may require subsequent buffering.

Other applications may require filtering at the input of the current sense amplifier. Figure 33 shows the recommended schematic for input filtering.



**Figure 33. Input filtering compensates for shunt inductance on shunts less than 1 mΩ, as well as high frequency noise in any application**

Input filtering is complicated by the fact that the added resistance of the filter resistors and the associated resistance mismatch between them can adversely affect gain, CMRR, and  $V_{OS}$ . The effect on  $V_{OS}$  is partly due to input bias currents as well. As a result, the value of the input resistors should be limited to 10 Ω or less. Ideally, select the capacitor to exactly match the time constant of the shunt resistor and its inductance; alternatively, select the capacitor to provide a pole below that point. As an example, a filtering frequency of 100 kHz would require an 80 nF capacitor. The capacitor can have a low voltage rating, but should have good high frequency characteristics.

Make the input filter time constant equal to or larger than the shunt and its inductance time constant:

$$\frac{L_{SHUNT}}{R_{SHUNT}} \leq 2 \cdot R_{FILT} \cdot C_{FILT}$$

This simplifies to determine the value of  $C_{FILT}$  based on using 10 Ω resistors for each  $R_{FILT}$ :

$$C_{FILT} \geq \frac{L_{SHUNT}}{20R_{SHUNT}}$$

If the main purpose is to filter high frequency noise, the capacitor should be increased to a value that provides the desired filtering.

As the shunt resistors decrease in value, shunt inductance can significantly affect frequency response. At values below 1 mΩ, the shunt inductance causes a zero in the transfer function that often results in corner frequencies in the low 100's of kHz. This inductance increases the amplitude of

high frequency spike transient events on the current sensing line that can overload the front end of any shunt current sensing IC. This problem must be solved by filtering at the input of the amplifier. Note that all current sensing IC's are vulnerable to this problem, regardless of manufacturer claims. Filtering is required at the input of the device to resolve this problem, even if the spike frequencies are above the rated bandwidth of the device.

#### Advantages When Used for Low-Side Current Sensing

The NCS21xR series offer many advantages for low-side current sensing. The true differential input is ideal for connection to either Kelvin Sensing shunts or conventional shunts. Additionally, the true differential input rejects the common-mode noise often present even in low-side current sensing. The NCS21xR also provides a reference pin to set the output offset from an external reference. Providing all of these features in a tiny package makes the NCS21xR very competitive when compared to discrete op amp solutions.

#### Designing for Input Transients Exceeding 30 Volts

For applications that have transient common-mode voltages greater than 30 volts, external input resistors of 10 Ω provide a convenient location to add either Zener diodes or transient voltage suppression diodes (also known as TVS diodes). There are two possible configurations: one using a single TVS diode with diodes across the amplifier inputs as shown in Figure 34, and the second configuration using two TVS diodes as shown in Figure 35.



Figure 34. Single TVS transient common-mode protection



Figure 35. Dual TVS Transient Common-mode Protection

Use Zener diodes or unidirectional TVS diodes with clamping voltage ratings up to a maximum of 30 volts. Select TVS diodes with the lowest voltage rating possible for use in the system. There is a wide range between standoff voltage and maximum clamping voltage in TVS diodes. Most diodes rated at a standoff voltage of 18 V have a maximum clamping voltage of 29.2 V. Refer to the TVS data sheet and the parameters of your power supply to make the selection. In general, higher power TVS diodes demonstrate a sharper clamping knee; providing a tighter relationship between rated breakdown and maximum clamping voltage.

#### Selecting the Shunt Resistor

The desired accuracy of the current measurement determines the precision, shunt size, and the resistor value. The larger the resistor value, the more accurate the measurement possible, but a large resistor value also results in greater current loss.

For the most accurate measurements, use four terminal current sense resistors, as shown in Figure 36. It provides two terminals for the current path in the application circuit, and a second pair for the voltage detection path of the sense amplifier. This technique is also known as *Kelvin Sensing*. This insures that the voltage measured by the sense amplifier is the actual voltage across the resistor and does not include the small resistance of a combined connection. When using non-Kelvin shunts, follow manufacturer recommendations on how to lay out the sensing traces closely.



Figure 36. Surface Mount Kelvin Shunt

### Current Output Configuration

In applications where the readout boards are remotely located, the voltage output of the NCS21xR can be converted to a precision current output. The precision output current measurements are read more accurately as it overcomes the errors due to ground drops between the boards.



Figure 37. Remote Current Sensing

As shown in Figure 37, the  $R_{IOUT}$  resistor is added between the OUT pin and the REF pin to convert the voltage output to a current output which is taken from the REF pin to the readout board. This circuit is intended to function with low potentials between the boards due to ground drops or noise. The current output is simply the relationship of the normal output voltage of the NCS21xR:

$$I_{OUT} = \frac{V_{OUT}}{R_{IOUT}}$$

A resistor value of 1 k $\Omega$  for  $R_{IOUT}$  is always a convenient value as it provides 1 mA/V scaling.

On the readout board, for simplicity,  $R_{ITOV}$  can be equal to  $R_{IOUT}$  to provide identical voltage drops across both. It is important to take into consideration that  $R_{ITOV}$  and  $R_{IOUT}$  add additional voltage drops in the current measurement path. The current source can provide enough compliance to

overcome most ground voltage drop, stray voltages, and noise. However, accuracy will degrade if noise or ground drops exceed 1 V.

### Shutting Down the NCS21xR

While the NCS21xR does not provide a shutdown pin, a simple MOSFET, power switch, or logic gate can be used to switch off the power to the NCS21xR and eliminate the quiescent current. Note that the shunt input pins will always have a current flow via the input and feedback resistors (total resistance of each leg always equals slightly higher than 1 M $\Omega$ ). Also note that when powered, the shunt input pins will exhibit the specified and well-matched typical bias current of 39  $\mu$ A. The shunt input pins support the rated common mode voltage even when the NCS21xR does not have power applied.

# MECHANICAL CASE OUTLINE PACKAGE DIMENSIONS

ON Semiconductor®



1  
SCALE 2:1

SC-88/SC70-6/SOT-363  
CASE 419B-02  
ISSUE Y

DATE 11 DEC 2012

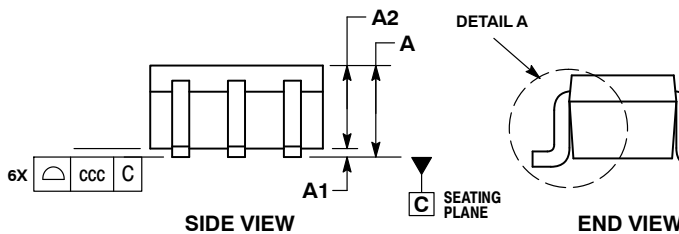

- NOTES:
1. DIMENSIONING AND TOLERANCING PER ASME Y14.5M, 1994.
  2. CONTROLLING DIMENSION: MILLIMETERS.
  3. DIMENSIONS D AND E1 DO NOT INCLUDE MOLD FLASH, PROTRUSIONS, OR GATE BURRS. MOLD FLASH, PROTRUSIONS, OR GATE BURRS SHALL NOT EXCEED 0.20 PER END.
  4. DIMENSIONS D AND E1 AT THE OUTERMOST EXTREMES OF THE PLASTIC BODY AND DATUM H.
  5. DATUMS A AND B ARE DETERMINED AT DATUM H.
  6. DIMENSIONS b AND c APPLY TO THE FLAT SECTION OF THE LEAD BETWEEN 0.08 AND 0.15 FROM THE TIP.
  7. DIMENSION b DOES NOT INCLUDE DAMBAR PROTRUSION. ALLOWABLE DAMBAR PROTRUSION SHALL BE 0.08 TOTAL IN EXCESS OF DIMENSION b AT MAXIMUM MATERIAL CONDITION. THE DAMBAR CANNOT BE LOCATED ON THE LOWER RADIUS OF THE FOOT.

| DIM | MILLIMETERS |      |      | INCHES    |       |       |
|-----|-------------|------|------|-----------|-------|-------|
|     | MIN         | NOM  | MAX  | MIN       | NOM   | MAX   |
| A   | ---         | ---  | 1.10 | ---       | ---   | 0.043 |
| A1  | 0.00        | ---  | 0.10 | 0.000     | ---   | 0.004 |
| A2  | 0.70        | 0.90 | 1.00 | 0.027     | 0.035 | 0.039 |
| b   | 0.15        | 0.20 | 0.25 | 0.006     | 0.008 | 0.010 |
| C   | 0.08        | 0.15 | 0.22 | 0.003     | 0.006 | 0.009 |
| D   | 1.80        | 2.00 | 2.20 | 0.070     | 0.078 | 0.086 |
| E   | 2.00        | 2.10 | 2.20 | 0.078     | 0.082 | 0.086 |
| E1  | 1.15        | 1.25 | 1.35 | 0.045     | 0.049 | 0.053 |
| e   | 0.65 BSC    |      |      | 0.026 BSC |       |       |
| L   | 0.26        | 0.36 | 0.46 | 0.010     | 0.014 | 0.018 |
| L2  | 0.15 BSC    |      |      | 0.006 BSC |       |       |
| aaa | 0.15        |      |      | 0.006     |       |       |
| bbb | 0.30        |      |      | 0.012     |       |       |
| ccc | 0.10        |      |      | 0.004     |       |       |
| ddd | 0.10        |      |      | 0.004     |       |       |

### GENERIC MARKING DIAGRAM\*

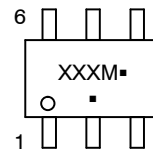

- XXX = Specific Device Code
- M = Date Code\*
- = Pb-Free Package

(Note: Microdot may be in either location)

\*Date Code orientation and/or position may vary depending upon manufacturing location.

\*This information is generic. Please refer to device data sheet for actual part marking. Pb-Free indicator, "G" or microdot "▪", may or may not be present.

### RECOMMENDED SOLDERING FOOTPRINT\*

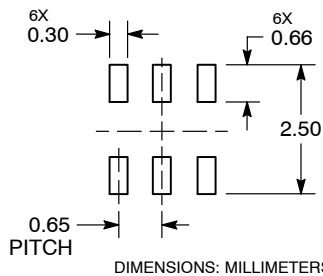

\*For additional information on our Pb-Free strategy and soldering details, please download the ON Semiconductor Soldering and Mounting Techniques Reference Manual, SOLDERRM/D.

STYLES ON PAGE 2

|                  |                           |  |
|------------------|---------------------------|--|
| DOCUMENT NUMBER: | 98ASB42985B               | Electronic versions are uncontrolled except when accessed directly from the Document Repository. Printed versions are uncontrolled except when stamped "CONTROLLED COPY" in red. |
| STATUS:          | ON SEMICONDUCTOR STANDARD |  |
| NEW STANDARD:    |                           |  |
| DESCRIPTION:     | SC-88/SC70-6/SOT-363      | PAGE 1 OF 3  |

**SC-88/SC70-6/SOT-363**  
**CASE 419B-02**  
**ISSUE Y**

DATE 11 DEC 2012

|  |  |   |   |   |   |
|--|--|---|---|---|---|
| STYLE 1:<br>PIN 1. EMITTER 2<br>2. BASE 2<br>3. COLLECTOR 1<br>4. EMITTER 1<br>5. BASE 1<br>6. COLLECTOR 2 | STYLE 2:<br>CANCELLED  | STYLE 3:<br>CANCELLED   | STYLE 4:<br>PIN 1. CATHODE<br>2. CATHODE<br>3. COLLECTOR<br>4. EMITTER<br>5. BASE<br>6. ANODE               | STYLE 5:<br>PIN 1. ANODE<br>2. ANODE<br>3. COLLECTOR<br>4. EMITTER<br>5. BASE<br>6. CATHODE                 | STYLE 6:<br>PIN 1. ANODE 2<br>2. N/C<br>3. CATHODE 1<br>4. ANODE 1<br>5. N/C<br>6. CATHODE 2          |
| STYLE 7:<br>PIN 1. SOURCE 2<br>2. DRAIN 2<br>3. GATE 1<br>4. SOURCE 1<br>5. DRAIN 1<br>6. GATE 2           | STYLE 8:<br>CANCELLED  | STYLE 9:<br>PIN 1. EMITTER 2<br>2. EMITTER 1<br>3. COLLECTOR 1<br>4. BASE 1<br>5. BASE 2<br>6. COLLECTOR 2  | STYLE 10:<br>PIN 1. SOURCE 2<br>2. SOURCE 1<br>3. GATE 1<br>4. DRAIN 1<br>5. DRAIN 2<br>6. GATE 2           | STYLE 11:<br>PIN 1. CATHODE 2<br>2. CATHODE 2<br>3. ANODE 1<br>4. CATHODE 1<br>5. CATHODE 1<br>6. ANODE 2   | STYLE 12:<br>PIN 1. ANODE 2<br>2. ANODE 2<br>3. CATHODE 1<br>4. ANODE 1<br>5. ANODE 1<br>6. CATHODE 2 |
| STYLE 13:<br>PIN 1. ANODE<br>2. N/C<br>3. COLLECTOR<br>4. EMITTER<br>5. BASE<br>6. CATHODE                 | STYLE 14:<br>PIN 1. VREF<br>2. GND<br>3. GND<br>4. IOUT<br>5. VEN<br>6. VCC                            | STYLE 15:<br>PIN 1. ANODE 1<br>2. ANODE 2<br>3. ANODE 3<br>4. CATHODE 3<br>5. CATHODE 2<br>6. CATHODE 1     | STYLE 16:<br>PIN 1. BASE 1<br>2. EMITTER 2<br>3. COLLECTOR 2<br>4. BASE 2<br>5. EMITTER 1<br>6. COLLECTOR 1 | STYLE 17:<br>PIN 1. BASE 1<br>2. EMITTER 1<br>3. COLLECTOR 2<br>4. BASE 2<br>5. EMITTER 2<br>6. COLLECTOR 1 | STYLE 18:<br>PIN 1. VIN1<br>2. VCC<br>3. VOUT2<br>4. VIN2<br>5. GND<br>6. VOUT1                       |
| STYLE 19:<br>PIN 1. IOUT<br>2. GND<br>3. GND<br>4. V CC<br>5. V EN<br>6. V REF                             | STYLE 20:<br>PIN 1. COLLECTOR<br>2. COLLECTOR<br>3. BASE<br>4. EMITTER<br>5. COLLECTOR<br>6. COLLECTOR | STYLE 21:<br>PIN 1. ANODE 1<br>2. N/C<br>3. ANODE 2<br>4. CATHODE 2<br>5. N/C<br>6. CATHODE 1               | STYLE 22:<br>PIN 1. D1 (i)<br>2. GND<br>3. D2 (j)<br>4. D2 (c)<br>5. VBUS<br>6. D1 (c)                      | STYLE 23:<br>PIN 1. Vn<br>2. CH1<br>3. Vp<br>4. N/C<br>5. CH2<br>6. N/C                                     | STYLE 24:<br>PIN 1. CATHODE<br>2. ANODE<br>3. CATHODE<br>4. CATHODE<br>5. CATHODE<br>6. CATHODE       |
| STYLE 25:<br>PIN 1. BASE 1<br>2. CATHODE<br>3. COLLECTOR 2<br>4. BASE 2<br>5. EMITTER<br>6. COLLECTOR 1    | STYLE 26:<br>PIN 1. SOURCE 1<br>2. GATE 1<br>3. DRAIN 2<br>4. SOURCE 2<br>5. GATE 2<br>6. DRAIN 1      | STYLE 27:<br>PIN 1. BASE 2<br>2. BASE 1<br>3. COLLECTOR 1<br>4. EMITTER 1<br>5. EMITTER 2<br>6. COLLECTOR 2 | STYLE 28:<br>PIN 1. DRAIN<br>2. DRAIN<br>3. GATE<br>4. SOURCE<br>5. DRAIN<br>6. DRAIN                       | STYLE 29:<br>PIN 1. ANODE<br>2. ANODE<br>3. COLLECTOR<br>4. EMITTER<br>5. BASE/ANODE<br>6. CATHODE          | STYLE 30:<br>PIN 1. SOURCE 1<br>2. DRAIN 2<br>3. DRAIN 2<br>4. SOURCE 2<br>5. GATE 1<br>6. DRAIN 1    |

|                         |                                  |  |
|-------------------------|----------------------------------|--|
| <b>DOCUMENT NUMBER:</b> | <b>98ASB42985B</b>               | Electronic versions are uncontrolled except when accessed directly from the Document Repository. Printed versions are uncontrolled except when stamped "CONTROLLED COPY" in red. |
| <b>STATUS:</b>          | <b>ON SEMICONDUCTOR STANDARD</b> |  |
| <b>NEW STANDARD:</b>    |                                  |  |
| <b>DESCRIPTION:</b>     | <b>SC-88/SC-70/SOT-363</b>       | <b>PAGE 2 OF 3</b>   |





| ISSUE | REVISION   | DATE        |
|-------|--|-------------|
| H     | REVISION TO CHANGE LEGAL OWNER OF DOCUMENT FROM MOTOROLA TO ON SEMICONDUCTOR. DELETED DIM "V" WAS 0.3 MM-0.4 MM/0.012-0.016 IN. REQ BY G KWONG | 14 JUN 01   |
| J     | ADDED STYLE 20. REQ BY M. ATANOVICH.   | 11 OCT 01   |
| K     | UPDATED STYLE 15 WAS PIN 1, 2 AND 3: ANODE. PIN 4, 5, AND 6 CATHODE. ADDED STYLE 21. REQ BY M. ATANOVICH                                       | 03 APR 02   |
| L     | ADDED STYLE 22. REQ BY S. CHANG  | 25 OCT 02   |
| M     | ADDED STYLE 23. REQ BY B. BLACKMON   | 04 DEC 02   |
| N     | ADDED STYLE 24. REQ BY B. BLACKMON   | 09 JAN 03   |
| P     | ADDED STYLE 25. REQ BY S. CHANG  | 09 MAY 03   |
| R     | REMOVED THE "1" AFTER EMITTER. REQ BY S. CHANG   | 03 JUN 03   |
| S     | ADDED STYLE 26. REQ BY A. BINEYARD   | 18 AUG 03   |
| T     | ADDED STYLE 27. REQ. BY M. SWEADOR   | 23 OCT 2003 |
| U     | ADDED STYLES 28 AND 29. REQ. BY A. BINEYARD AND S. BACHMAN   | 22 JAN 2004 |
| V     | ADDED NOM VALUES AND CHANGED DIMS TO INDUSTRY STANDARD. REQ. BY D. TRUHITTE  | 31 JAN 2005 |
| W     | ADDED STYLE 30. REQ. BY L. DELUCA.   | 26 JAN 2006 |
| Y     | UPDATED & REDREW TO JEDEC STANDARDS. REQ. BY D. TRUHITTE.  | 11 DEC 2012 |
|       |  |             |
|       |  |             |
|       |  |             |
|       |  |             |
|       |  |             |
|       |  |             |
|       |  |             |
|       |  |             |

ON Semiconductor and  are registered trademarks of Semiconductor Components Industries, LLC (SCILLC). SCILLC reserves the right to make changes without further notice to any products herein. SCILLC makes no warranty, representation or guarantee regarding the suitability of its products for any particular purpose, nor does SCILLC assume any liability arising out of the application or use of any product or circuit, and specifically disclaims any and all liability, including without limitation special, consequential or incidental damages. "Typical" parameters which may be provided in SCILLC data sheets and/or specifications can and do vary in different applications and actual performance may vary over time. All operating parameters, including "Typicals" must be validated for each customer application by customer's technical experts. SCILLC does not convey any license under its patent rights nor the rights of others. SCILLC products are not designed, intended, or authorized for use as components in systems intended for surgical implant into the body, or other applications intended to support or sustain life, or for any other application in which the failure of the SCILLC product could create a situation where personal injury or death may occur. Should Buyer purchase or use SCILLC products for any such unintended or unauthorized application, Buyer shall indemnify and hold SCILLC and its officers, employees, subsidiaries, affiliates, and distributors harmless against all claims, costs, damages, and expenses, and reasonable attorney fees arising out of, directly or indirectly, any claim of personal injury or death associated with such unintended or unauthorized use, even if such claim alleges that SCILLC was negligent regarding the design or manufacture of the part. SCILLC is an Equal Opportunity/Affirmative Action Employer. This literature is subject to all applicable copyright laws and is not for resale in any manner.

# MECHANICAL CASE OUTLINE

## PACKAGE DIMENSIONS

ON Semiconductor®



### UQFN10 1.4x1.8, 0.4P CASE 488AT-01 ISSUE A

DATE 01 AUG 2007

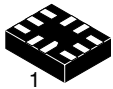

SCALE 5:1

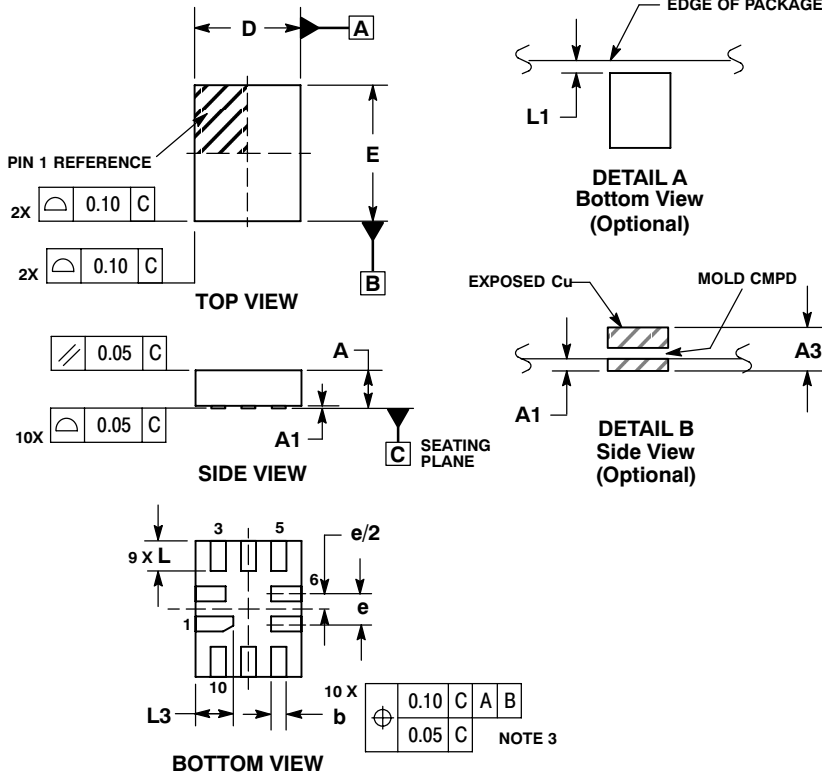

- NOTES:
1. DIMENSIONING AND TOLERANCING PER ASME Y14.5M, 1994.
  2. CONTROLLING DIMENSION: MILLIMETERS
  3. DIMENSION b APPLIES TO PLATED TERMINAL AND IS MEASURED BETWEEN 0.25 AND 0.30 MM FROM TERMINAL.
  4. COPLANARITY APPLIES TO THE EXPOSED PAD AS WELL AS THE TERMINALS.

| DIM | MILLIMETERS |      |
|-----|-------------|------|
|     | MIN         | MAX  |
| A   | 0.45        | 0.60 |
| A1  | 0.00        | 0.05 |
| A3  | 0.127 REF   |      |
| b   | 0.15        | 0.25 |
| D   | 1.40        | BSC  |
| E   | 1.80        | BSC  |
| e   | 0.40        | BSC  |
| L   | 0.30        | 0.50 |
| L1  | 0.00        | 0.15 |
| L3  | 0.40        | 0.60 |

### GENERIC MARKING DIAGRAM\*

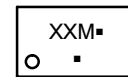

- XX = Specific Device Code
  - M = Date Code
  - = Pb-Free Package
- (Note: Microdot may be in either location)

\*This information is generic. Please refer to device data sheet for actual part marking. Pb-Free indicator, "G" or microdot "▪", may or may not be present.

### MOUNTING FOOTPRINT

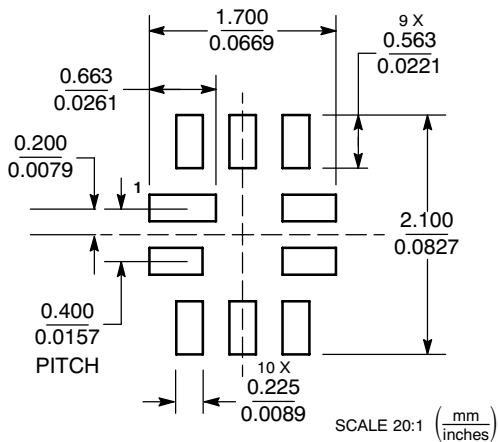

|                  |                              |  |
|------------------|------------------------------|--|
| DOCUMENT NUMBER: | 98AON22493D                  | Electronic versions are uncontrolled except when accessed directly from the Document Repository. Printed versions are uncontrolled except when stamped "CONTROLLED COPY" in red. |
| STATUS:          | ON SEMICONDUCTOR STANDARD    |  |
| NEW STANDARD:    |                              |  |
| DESCRIPTION:     | 10 PIN UQFN, 1.4 X 1.8, 0.4P | PAGE 1 OF 2  |

**ON Semiconductor®**



**DOCUMENT NUMBER:  
98AON22493D**

**PAGE 2 OF 2**

| <b>ISSUE</b> | <b>REVISION</b>                          | <b>DATE</b> |
|--------------|--|-------------|
| O            | RELEASED FOR PRODUCTION. REQ. BY E SOTO. | 28 APR 2006 |
| A            | ADDED DETAILS A AND B. REQ. BY E. SOTO.  | 01 AUG 2007 |
|              |  |             |
|              |  |             |
|              |  |             |
|              |  |             |
|              |  |             |
|              |  |             |
|              |  |             |
|              |  |             |
|              |  |             |
|              |  |             |
|              |  |             |
|              |  |             |
|              |  |             |
|              |  |             |
|              |  |             |
|              |  |             |
|              |  |             |
|              |  |             |
|              |  |             |
|              |  |             |
|              |  |             |
|              |  |             |
|              |  |             |

**ON Semiconductor** and  are registered trademarks of Semiconductor Components Industries, LLC (SCILLC). SCILLC reserves the right to make changes without further notice to any products herein. SCILLC makes no warranty, representation or guarantee regarding the suitability of its products for any particular purpose, nor does SCILLC assume any liability arising out of the application or use of any product or circuit, and specifically disclaims any and all liability, including without limitation special, consequential or incidental damages. "Typical" parameters which may be provided in SCILLC data sheets and/or specifications can and do vary in different applications and actual performance may vary over time. All operating parameters, including "Typicals" must be validated for each customer application by customer's technical experts. SCILLC does not convey any license under its patent rights nor the rights of others. SCILLC products are not designed, intended, or authorized for use as components in systems intended for surgical implant into the body, or other applications intended to support or sustain life, or for any other application in which the failure of the SCILLC product could create a situation where personal injury or death may occur. Should Buyer purchase or use SCILLC products for any such unintended or unauthorized application, Buyer shall indemnify and hold SCILLC and its officers, employees, subsidiaries, affiliates, and distributors harmless against all claims, costs, damages, and expenses, and reasonable attorney fees arising out of, directly or indirectly, any claim of personal injury or death associated with such unintended or unauthorized use, even if such claim alleges that SCILLC was negligent regarding the design or manufacture of the part. SCILLC is an Equal Opportunity/Affirmative Action Employer. This literature is subject to all applicable copyright laws and is not for resale in any manner.

ON Semiconductor and  are trademarks of Semiconductor Components Industries, LLC dba ON Semiconductor or its subsidiaries in the United States and/or other countries. ON Semiconductor owns the rights to a number of patents, trademarks, copyrights, trade secrets, and other intellectual property. A listing of ON Semiconductor's product/patent coverage may be accessed at [www.onsemi.com/site/pdf/Patent-Marking.pdf](http://www.onsemi.com/site/pdf/Patent-Marking.pdf). ON Semiconductor reserves the right to make changes without further notice to any products herein. ON Semiconductor makes no warranty, representation or guarantee regarding the suitability of its products for any particular purpose, nor does ON Semiconductor assume any liability arising out of the application or use of any product or circuit, and specifically disclaims any and all liability, including without limitation special, consequential or incidental damages. Buyer is responsible for its products and applications using ON Semiconductor products, including compliance with all laws, regulations and safety requirements or standards, regardless of any support or applications information provided by ON Semiconductor. "Typical" parameters which may be provided in ON Semiconductor data sheets and/or specifications can and do vary in different applications and actual performance may vary over time. All operating parameters, including "Typicals" must be validated for each customer application by customer's technical experts. ON Semiconductor does not convey any license under its patent rights nor the rights of others. ON Semiconductor products are not designed, intended, or authorized for use as a critical component in life support systems or any FDA Class 3 medical devices or medical devices with a same or similar classification in a foreign jurisdiction or any devices intended for implantation in the human body. Should Buyer purchase or use ON Semiconductor products for any such unintended or unauthorized application, Buyer shall indemnify and hold ON Semiconductor and its officers, employees, subsidiaries, affiliates, and distributors harmless against all claims, costs, damages, and expenses, and reasonable attorney fees arising out of, directly or indirectly, any claim of personal injury or death associated with such unintended or unauthorized use, even if such claim alleges that ON Semiconductor was negligent regarding the design or manufacture of the part. ON Semiconductor is an Equal Opportunity/Affirmative Action Employer. This literature is subject to all applicable copyright laws and is not for resale in any manner.

## PUBLICATION ORDERING INFORMATION

### LITERATURE FULFILLMENT:

Literature Distribution Center for ON Semiconductor  
19521 E. 32nd Pkwy, Aurora, Colorado 80011 USA  
**Phone:** 303-675-2175 or 800-344-3860 Toll Free USA/Canada  
**Fax:** 303-675-2176 or 800-344-3867 Toll Free USA/Canada  
**Email:** [orderlit@onsemi.com](mailto:orderlit@onsemi.com)

**N. American Technical Support:** 800-282-9855 Toll Free  
USA/Canada  
**Europe, Middle East and Africa Technical Support:**  
Phone: 421 33 790 2910

**ON Semiconductor Website:** [www.onsemi.com](http://www.onsemi.com)

**Order Literature:** <http://www.onsemi.com/orderlit>

For additional information, please contact your local  
Sales Representative