



totem

# LIFT MOBILE

Assembly guide

**DIY APP  
CONTROLLED**

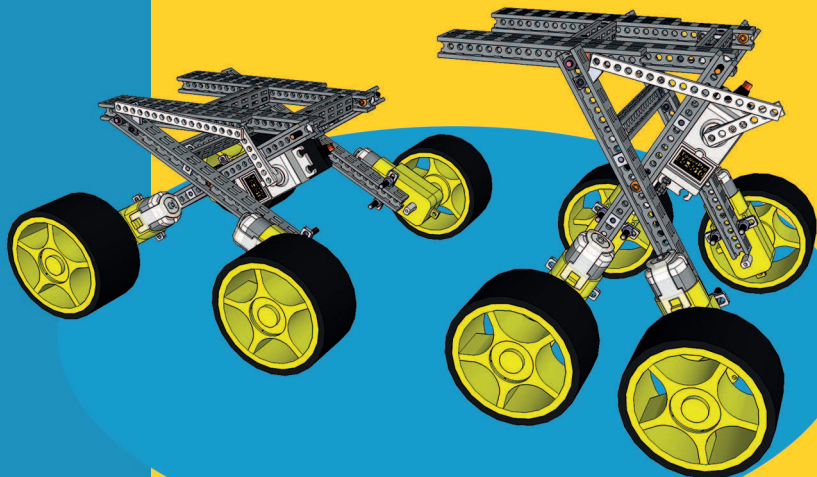

v.1.4

# STARTING TIPS

### Inserting nuts (1)

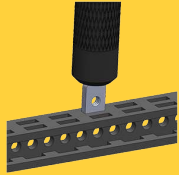

It is a good idea to start every step inserting nuts into beams (if the step requires). Use the back of the screwdriver to push in the nuts.

### Inserting nuts (2)

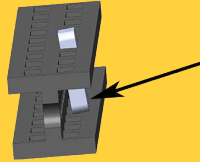

After entering the first slot, nuts tend to tilt. Use your thumb to push it back straight, and then again use the screwdriver to insert the nut all the way in.

### Faulty threads

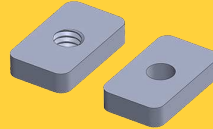

Some of the nuts are missing threads. This is a manufacturing issue and we are working on it. In the mean time, we add few extra nuts. We apologize for the inconvenience.

### Tightening standoffs

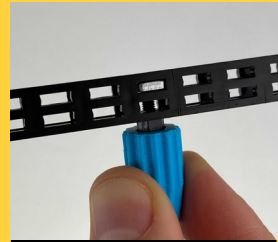

Use the Totem Wrench Socket (Blue) to insert Nylon Standoffs used to assemble the electronics boards.

### Ruler



Use Beam/Bolt ruler to determine the length of beams and bolts.

For more tips, please visit the link below:

<https://totemmaker.net/blog/totem-mechanics-for-beginners/>

## BEFORE YOU START BUILDING:



Bolt colour codes:

We have put some colours to bolts to make instructions more clear.



NOTE: 2x 8mm

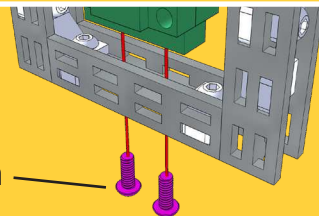

Notes for bolts other than 6mm:

When bolts that are not 6mm will be used, in addition to colours, extra notes are given in the instructions with lengths in mm.

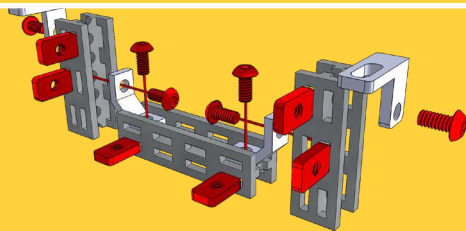

6mm bolts and 6x10mm nuts:

When starting on a building step, the 6mm bolts and 6x10 nuts are coloured **RED**. It makes it easier to see where the new bolts and nuts are placed.

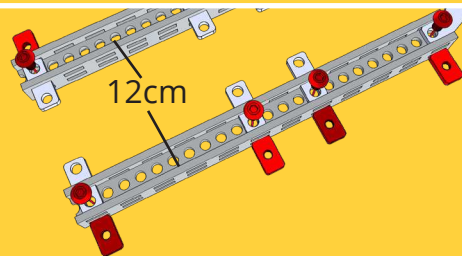

I-beams lengths.

When a new Totem beam is needed in a step, the length is indicated in centimeters.

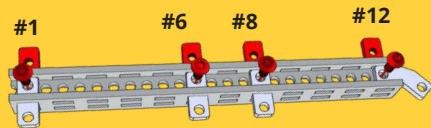

Positions for nuts with #-symbol.

When it is helpful, the slot-number is indicated in the Totem beam. Starting from #1 and counting slots.

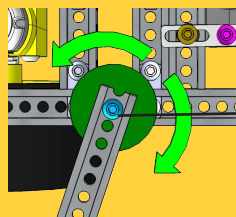

Don't tighten links too much.

Green Rotating Arrows = rotating action.

When a connection is a rotating hub, you must not tighten the bolt and nut too much. Test it for a smooth rotation, but not too wobbly either.

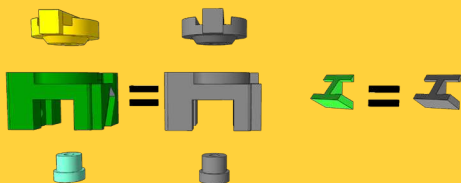

The colour of parts.

The colours of plastic part may vary. Colours are often changed on parts to make it easier to see them in the instructions pictures.

Totem Wrench Socket

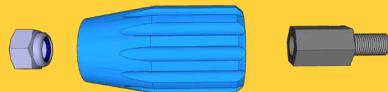















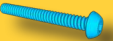























Helpful little tool:

Included in the kit is a small hex-socket used for fastening Lock Nuts and Nylon Towers. The pointy end is for Lock Nuts.



# PARTS LIST:

34x  Bolt M3x6	8x  Bolt M3x8	8x  Bolt M3x10	2x  Bolt M3x12	4x  Bolt M3x16	2x  Bolt M3x20	10x  Bolt M3x25										
60x  Nut M3 6x10	2x  Nut M3 5,5x5,5	10x  Lock Nut M3	6x  Metal washer M3 9x0.8mm	8x  2-hole Simple	4x  2-hole 90 bracket	4x  L-Twisted										
4x  L-Twisted mirrored	4x  3 hole bracket	2x  2-hole 45 simple	4x  2-hole bracket	4x  Beam plug	8x  Nylon Spacer 4mm	2x  Nylon Spacer 8mm										
4x  Nylon Standoff M3x8mm	4x  Yellow Wheel D 67mm	4x  Yellow DC motor 1:48	2x  Washer 1 mm DIA24mm	1x  Totem Wrench Socket	1x  Allen hex key											
1x  Totem Screw Driver	1x  X3 Controller Board	1x  Li-Ion 3.7v Battery	1x  USB Battery Charger	3-5x  ZIP Tie		<table border="1"> <tbody> <tr> <td>5 cm</td> <td>2x</td> </tr> <tr> <td>7 cm</td> <td>2x</td> </tr> <tr> <td>10 cm</td> <td>4x</td> </tr> <tr> <td>14 cm</td> <td>2x</td> </tr> <tr> <td>16 cm</td> <td>4x</td> </tr> </tbody> </table>	5 cm	2x	7 cm	2x	10 cm	4x	14 cm	2x	16 cm	4x
5 cm	2x															
7 cm	2x															
10 cm	4x															
14 cm	2x															
16 cm	4x															
1x  5.5mm Totem Wrench	1x  Servo arm Index Disc set	2x  Mini Servo Motor	2x  Arm for Mini Servo Motor	2x  Bolt M2.5x8 For servo arm	<table border="1"> <tbody> <tr> <td>4cm/8H</td> <td>2x</td> </tr> <tr> <td>8cm/16H</td> <td>2x</td> </tr> </tbody> </table>	4cm/8H	2x	8cm/16H	2x							
4cm/8H	2x															
8cm/16H	2x															

# PART 1

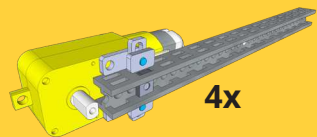

4x



Bolt M3x6

8x



Bolt M3x25

12x



Nut M3 6x10

8x



2-hole Simple

4x



3 hole bracket

4x



Yellow DC motor 1:48

16 cm

4x

①

16 cm

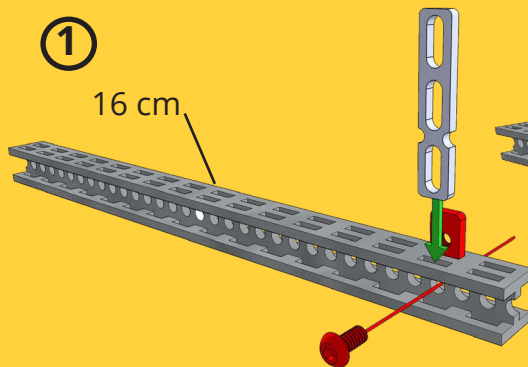

②

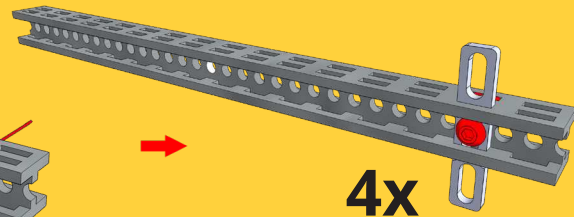

4x

③

⚠ Note: 2x 25mm

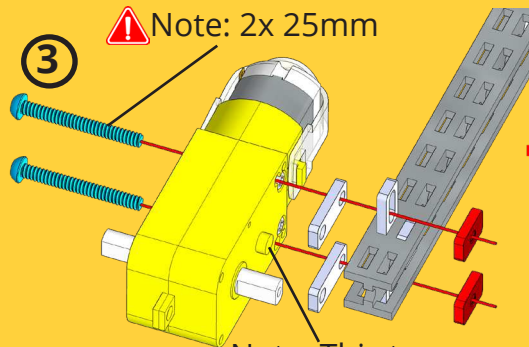

⚠ Note: This tap to this side.

④

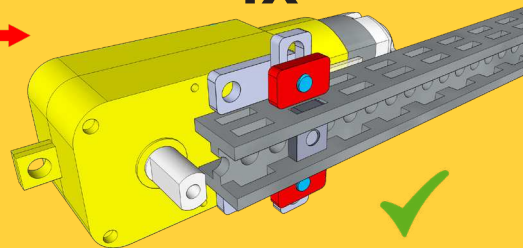



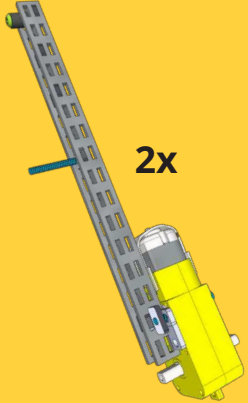

4x

PART 1

# PART 2



2x

2x	2x
	
Bolt M3x12	Bolt M3x25
8x	2x
	
Nut M3 6x10	Nylon Spacer 8mm

①

#1

#3

#5

#8

2x PART 1

②

2x

③

Note: 25mm

Note: 12mm







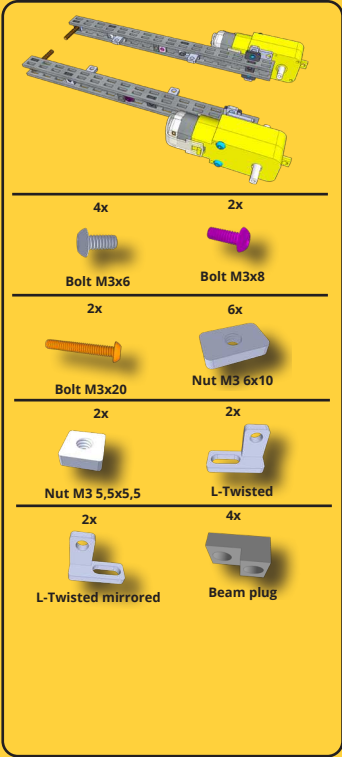

④

2x

✓ PART 2

# PART 3



	4x		2x
<b>Bolt M3x6</b>		<b>Bolt M3x8</b>	
	2x		6x
<b>Bolt M3x20</b>		<b>Nut M3 6x10</b>	
	2x		2x
<b>Nut M3 5,5x5,5</b>		<b>L-Twisted</b>	
	2x		4x
<b>L-Twisted mirrored</b>		<b>Beam plug</b>	

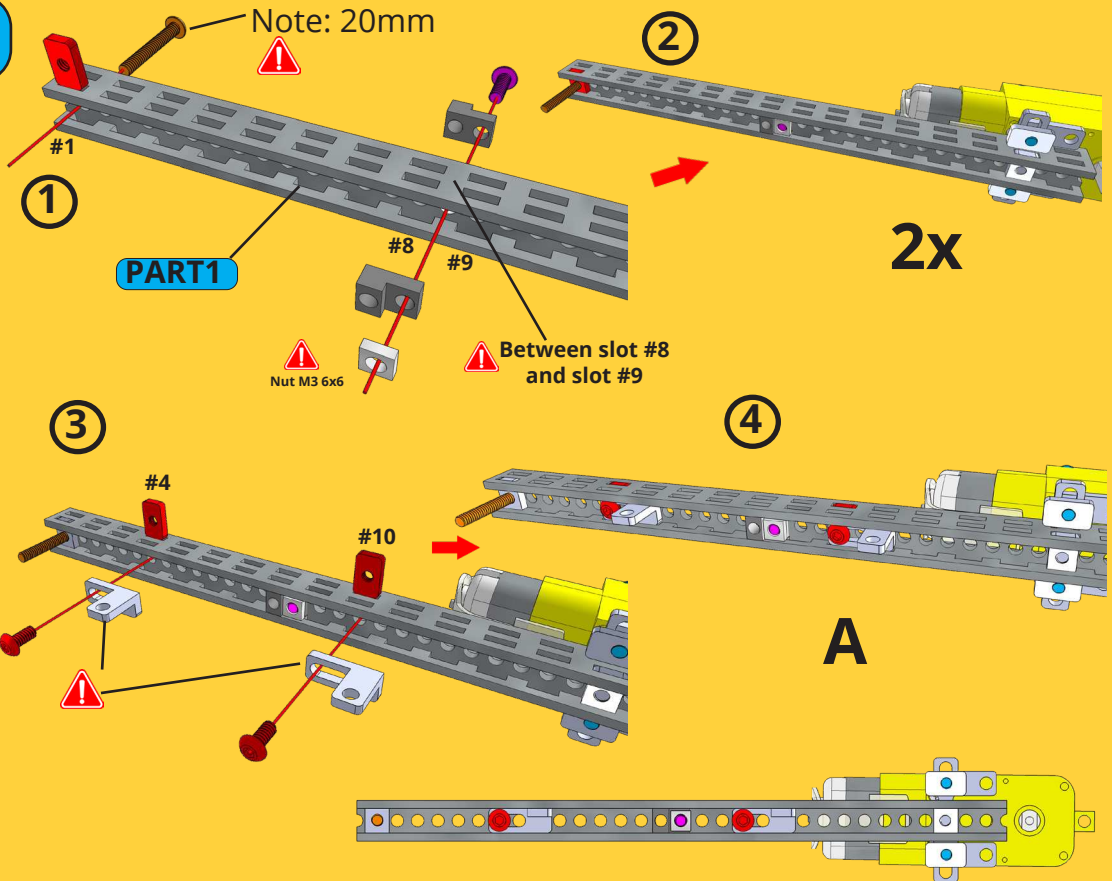



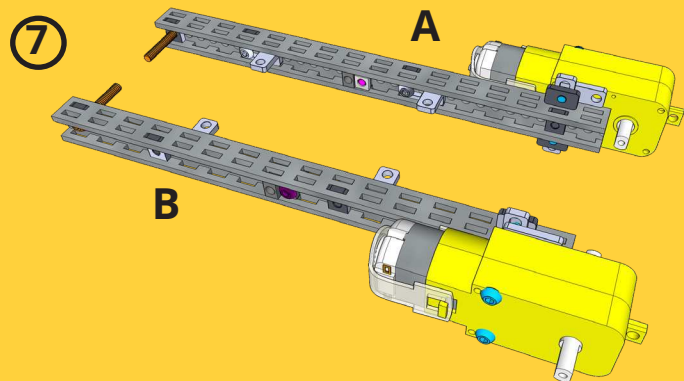
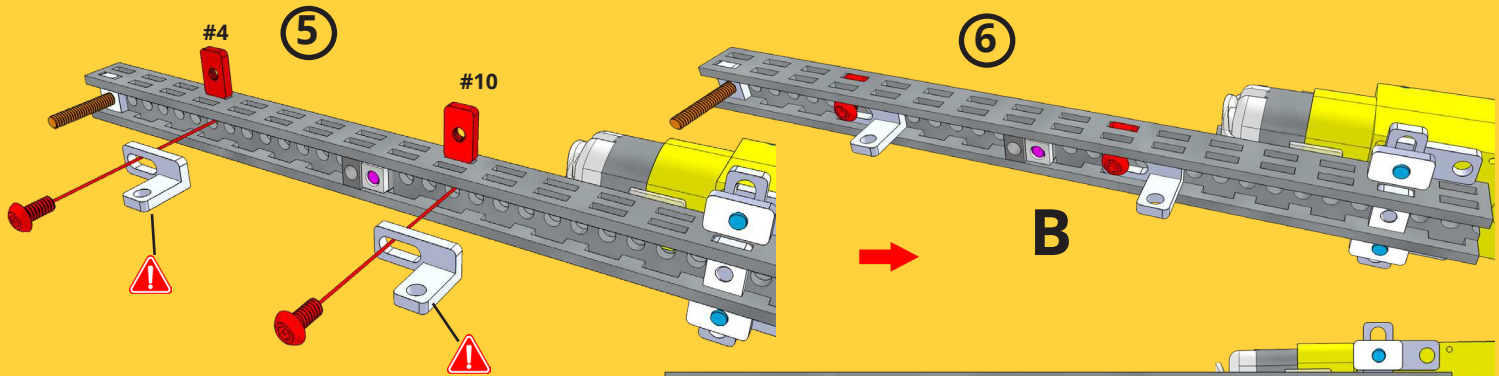

✓ **PART 3**

# PART 4

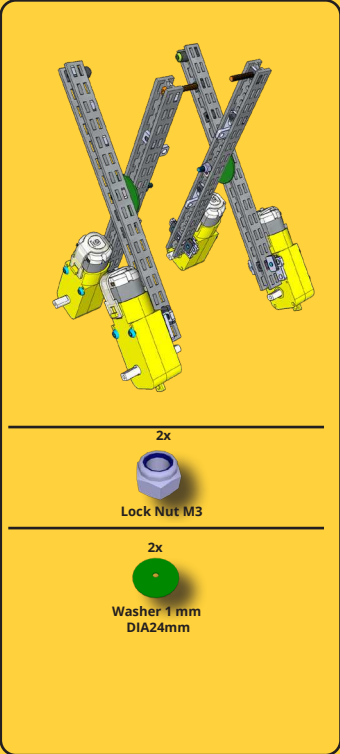

①

PART2

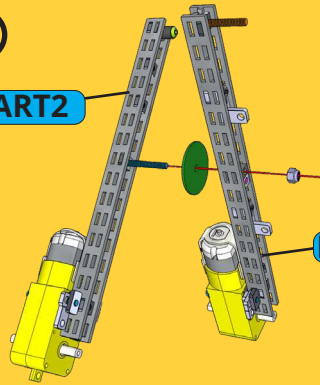

PART3-B

②

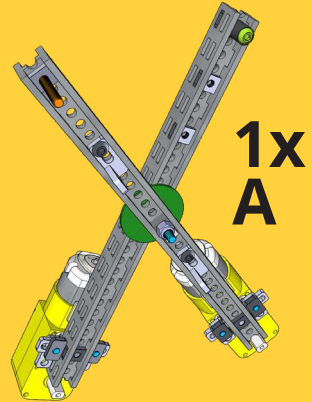

③

PART2

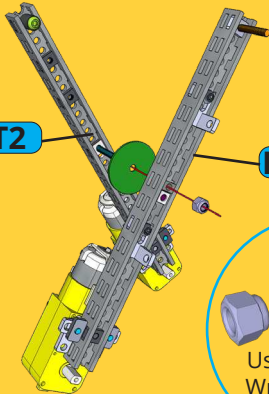

PART3-A



④

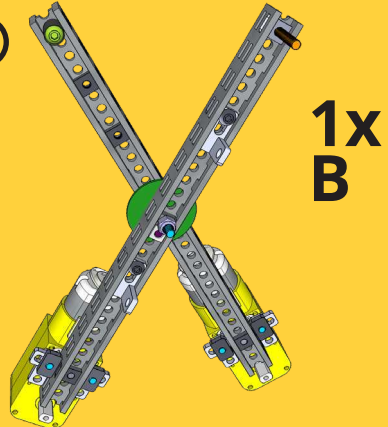

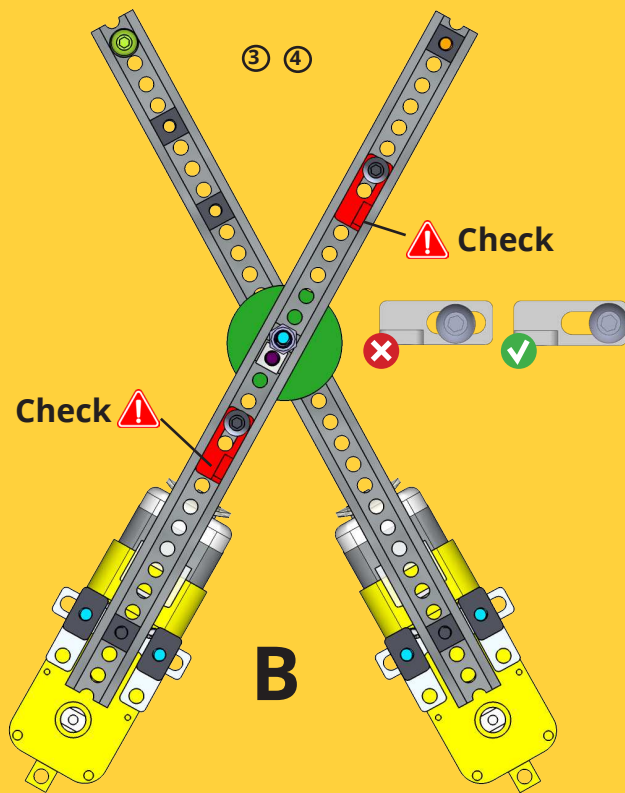
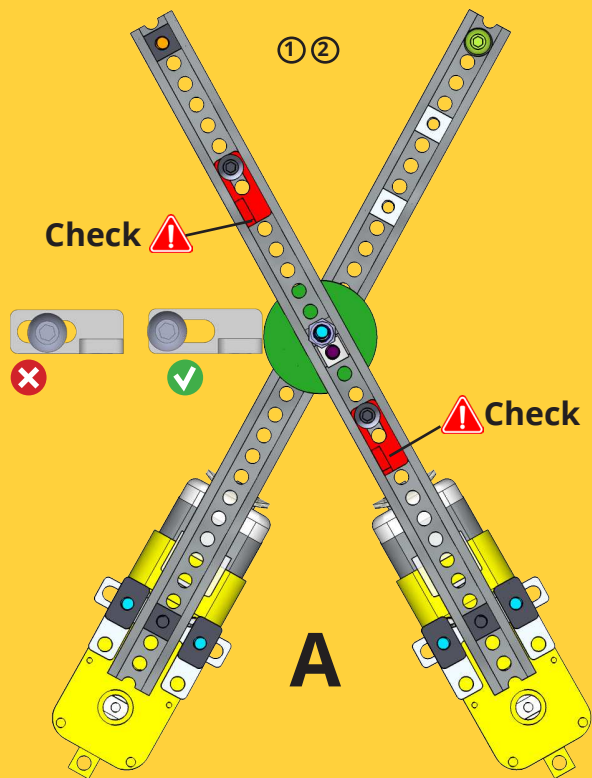

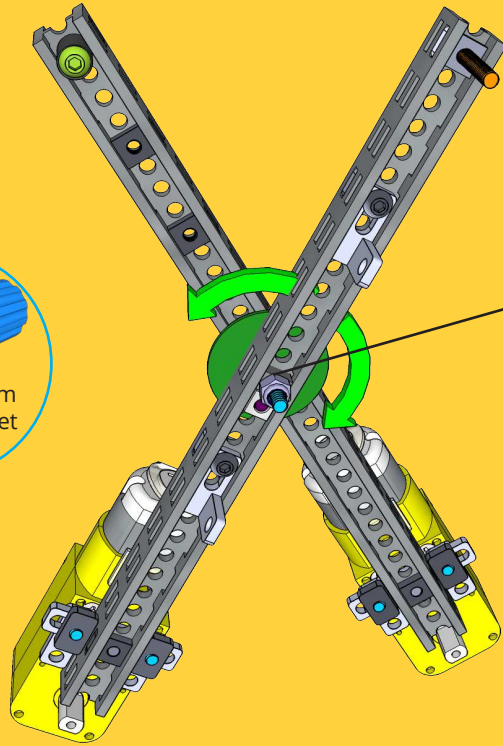

Make sure that the 2 legs have a smooth rotation.

If it is too tight, the function may fail because the servos cannot manage to lift properly.



**PART 4**

# PART 5

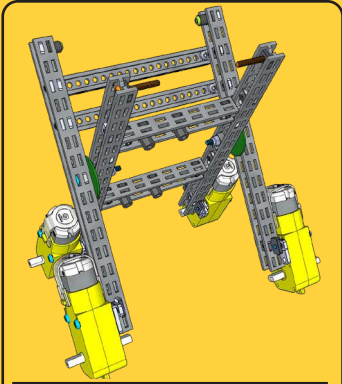

12x	12x
Bolt M3x6	Nut M3 6x10
4x	4x
2-hole 90 bracket	Nylon Standoff M3x8mm
7 cm	2x
10 cm	2x

①

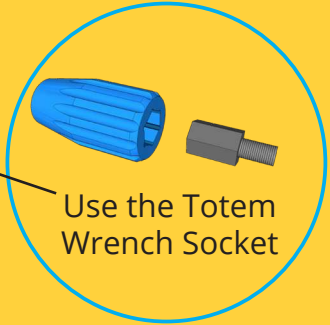
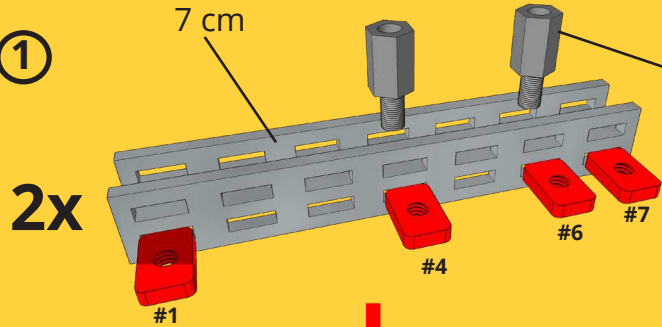

②

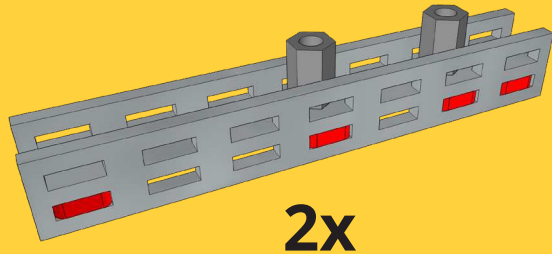

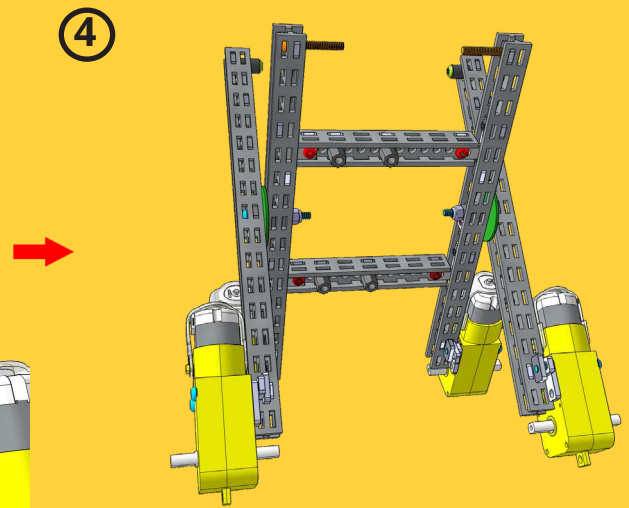
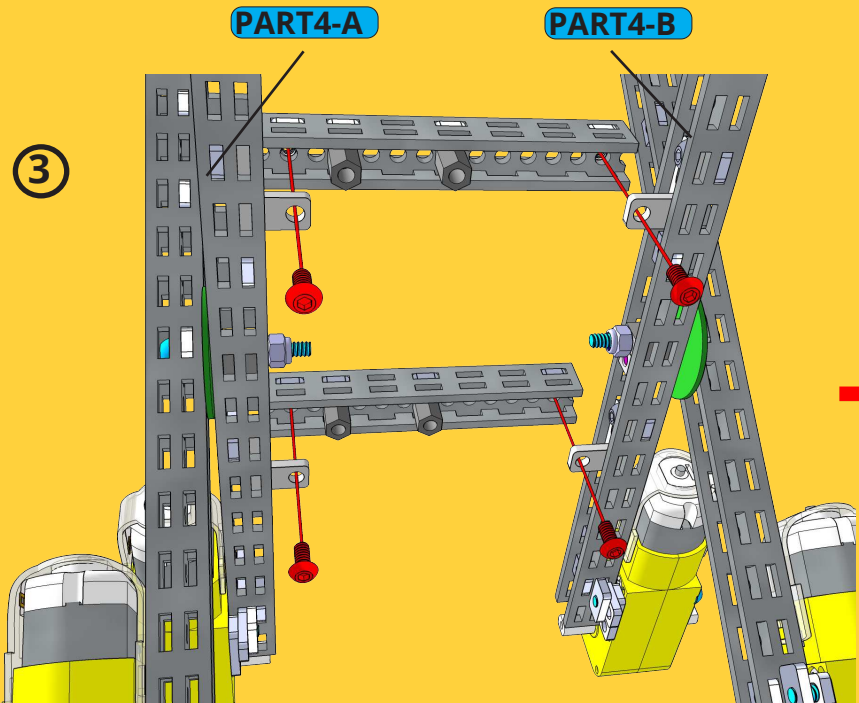

5

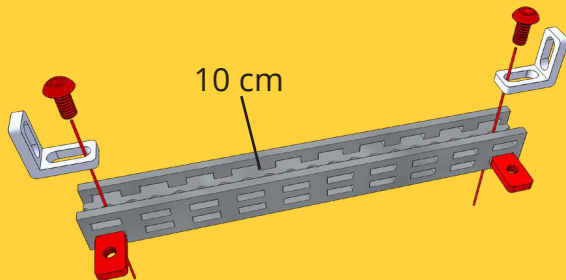

6

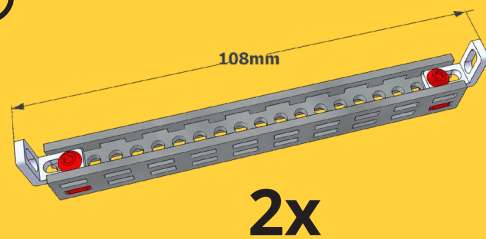

7

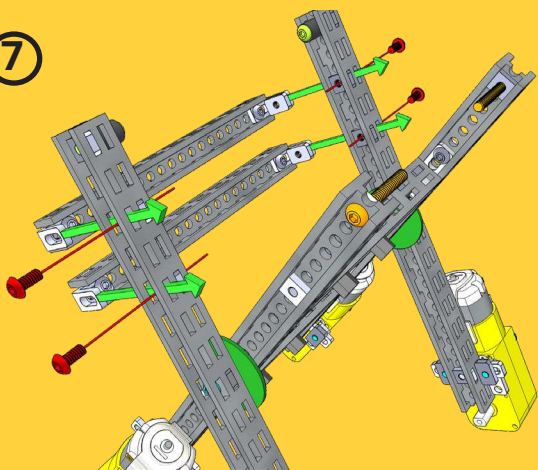



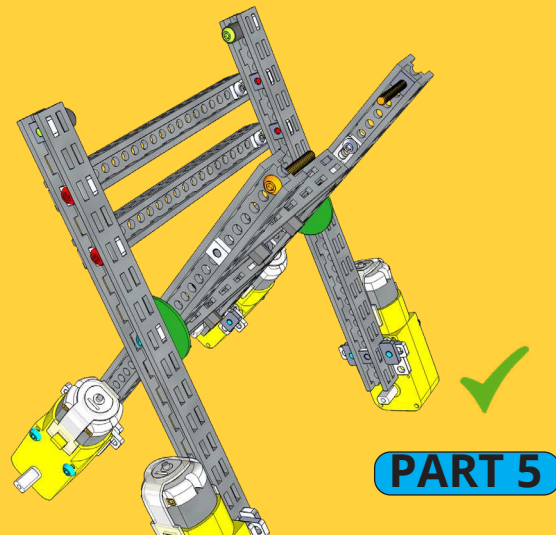

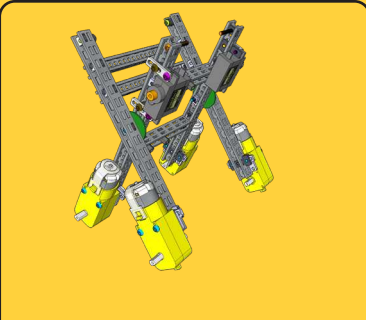

8



# PART 6



4x	4x
	
Bolt M3x8	Bolt M3x10
8x	4x
	
Nut M3 6x10	2-hole bracket
4x	2x
	
Nylon Spacer 4mm	Mini Servo Motor

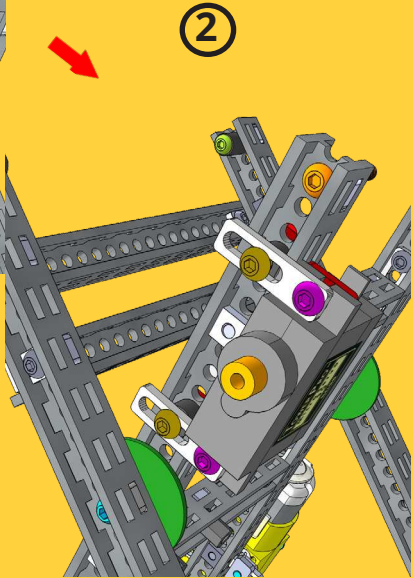
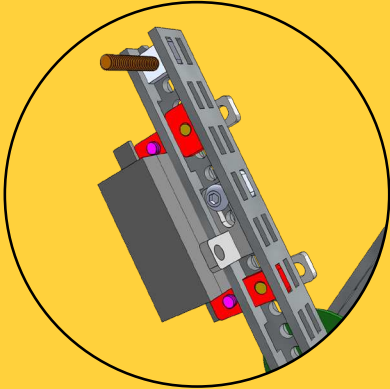
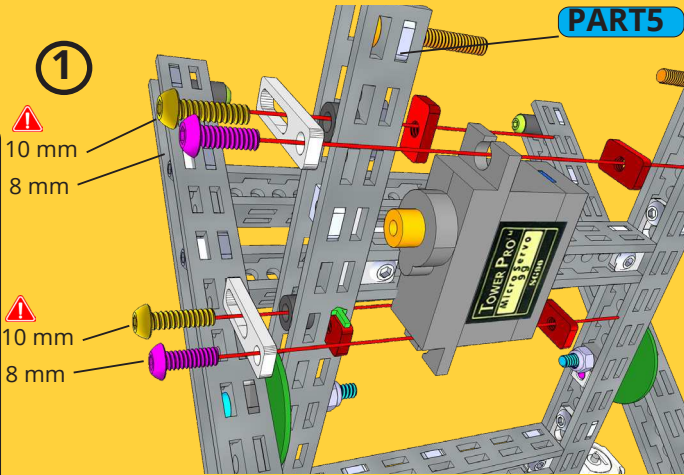



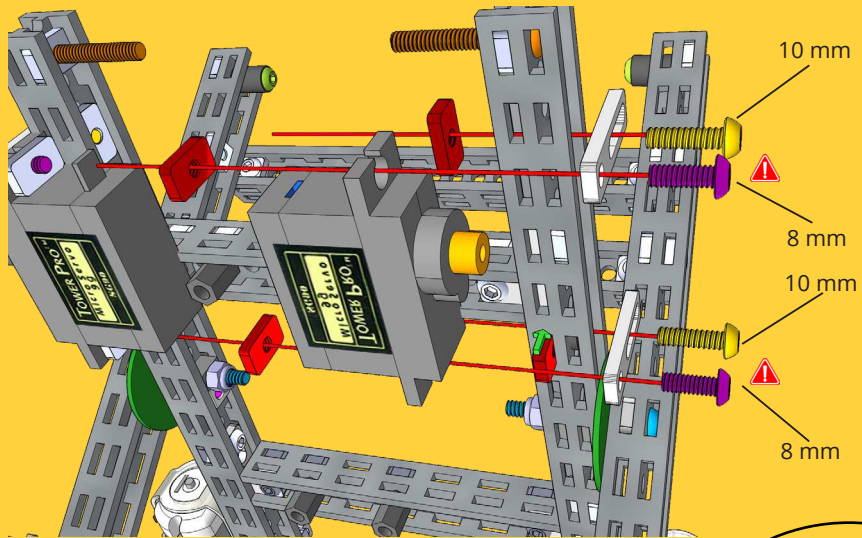

3

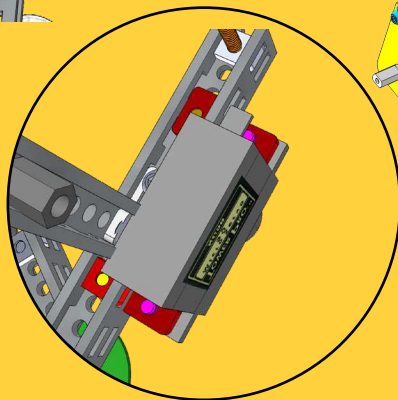



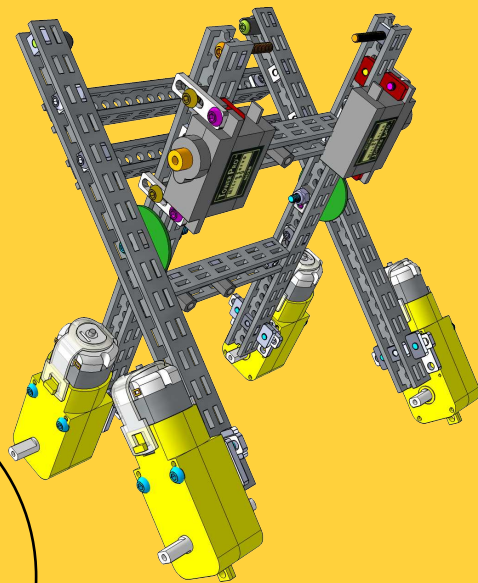





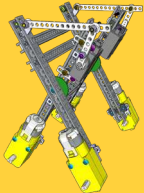

4



PART 6

# PART 7



2x  Bolt M3x6	2x  Bolt M3x8				
4x  Bolt M3x10	2x  Nut M3 6x10				
2x  2-hole 45 simple	6x  Lock Nut M3				
4x  Metal washer M3 9x0.8mm	2x  Arm for Mini Servo Motor				
2x  Bolt M2.5x8 For servo arm	<table border="1"> <tr> <td>4 cm/8H</td> <td>2x</td> </tr> <tr> <td>8cm/16H</td> <td>2x</td> </tr> </table>	4 cm/8H	2x	8cm/16H	2x
4 cm/8H	2x				
8cm/16H	2x				

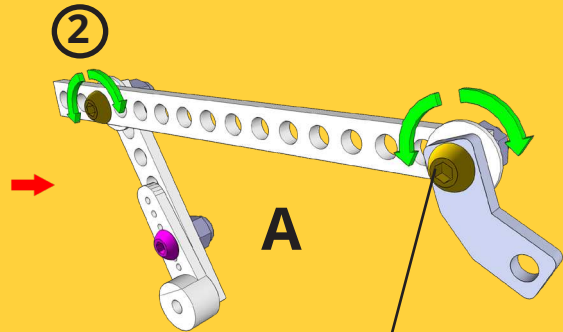
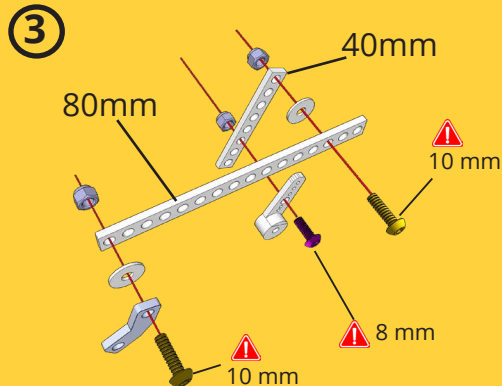
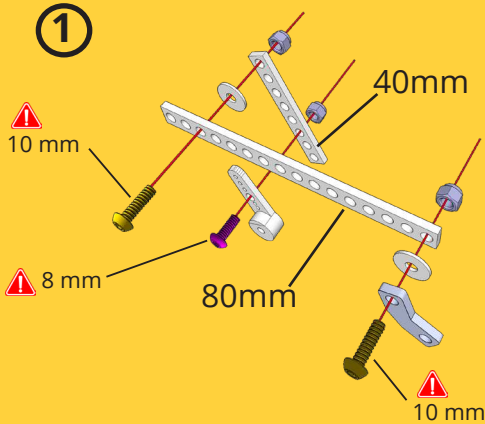

Don't tighten the bolts too much. Make sure there is smooth action. Not too wobbly, but also not too tight.

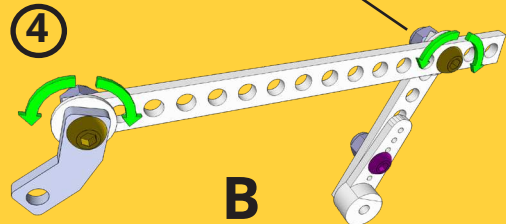

# Register the servo arm.

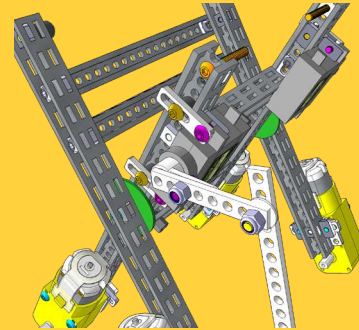
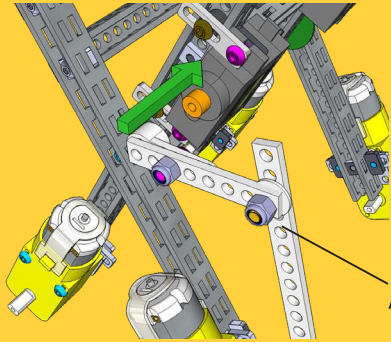

**A : Put on the servo arm assembly in any position.**

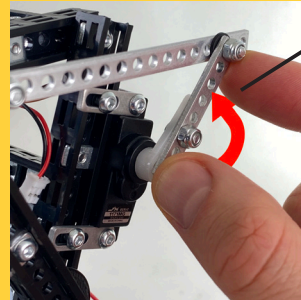
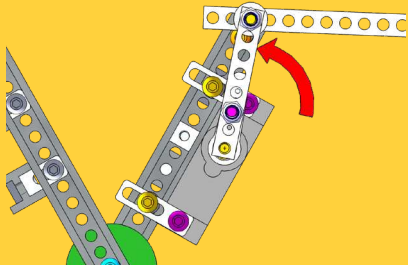

**B : Manually twist the arm Counter Clockwise until it stops.**



**Be careful.  
Don't use too  
much force. Gen-  
tly twist it Counter  
Clock-wise.**

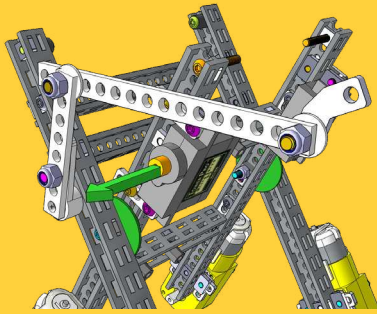

**C :** Temporarily take off the servo arm.

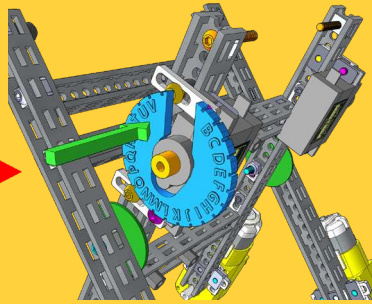

**D :** Slip on the Servo Arm Index Disc on to the servo.

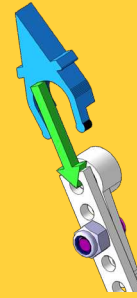

**E :** Attach the Servo Arm Index Arrow on to the servo arm.

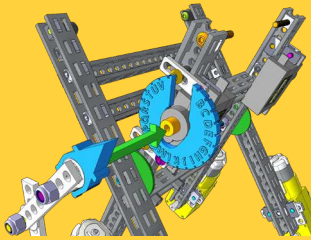

**F :** Put the Servo Arm with Index Arrow back on the servo matching the "B" mark on the disc.

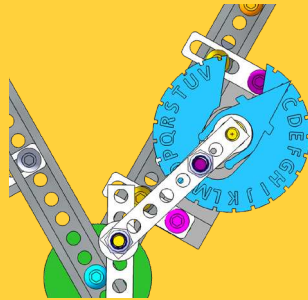

**G :** Here you can see the arrow points to the "B" index mark.

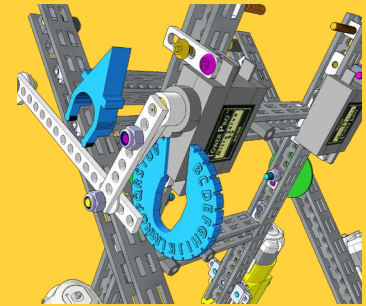

**H :** Take off the disc and arrow. Make sure the servo arm stays.

5

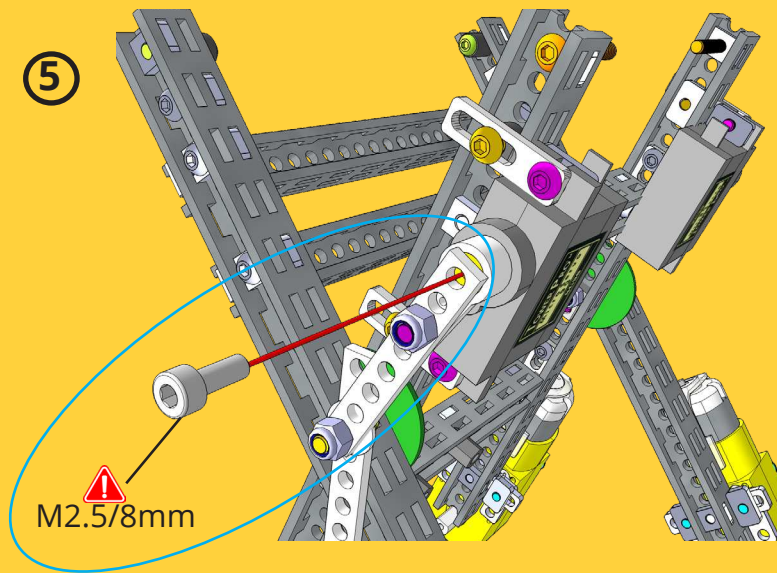

6

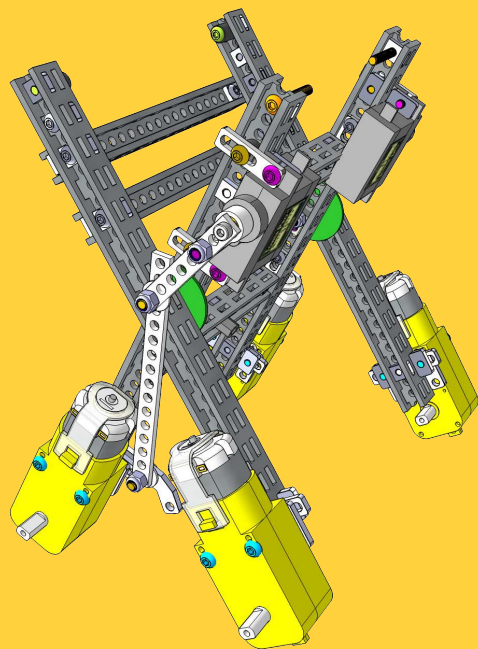

⑦

**Servo arm on the other side (arm B):**

**Same procedure as first servo. But the index mark is "K" position.**

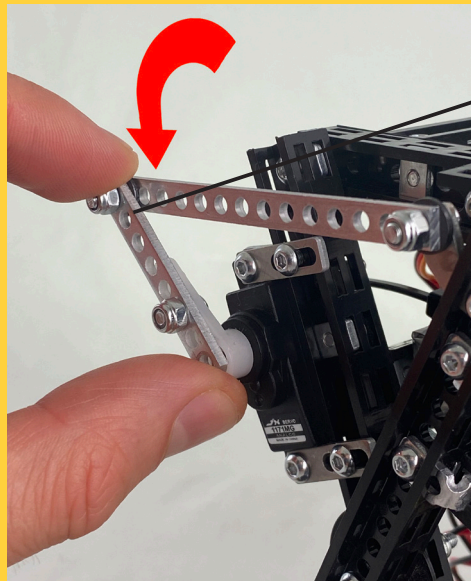
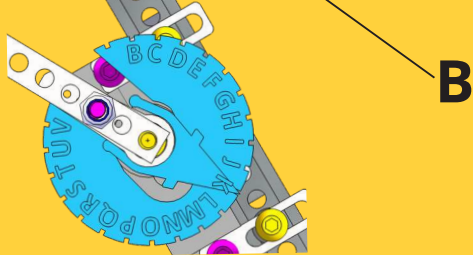
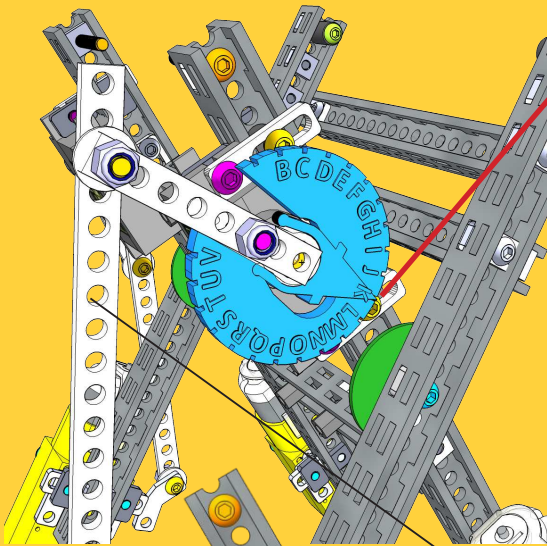

**Same as the other side:  
Be careful.  
Don't use too much force. Gently twist it Counter Clock-wise.**

8

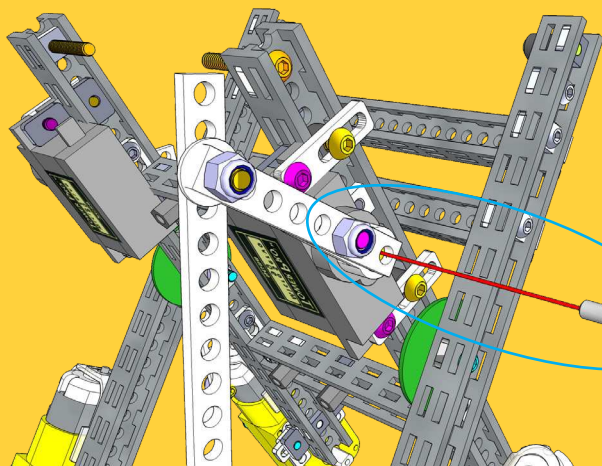

 M2.5/8mm

9

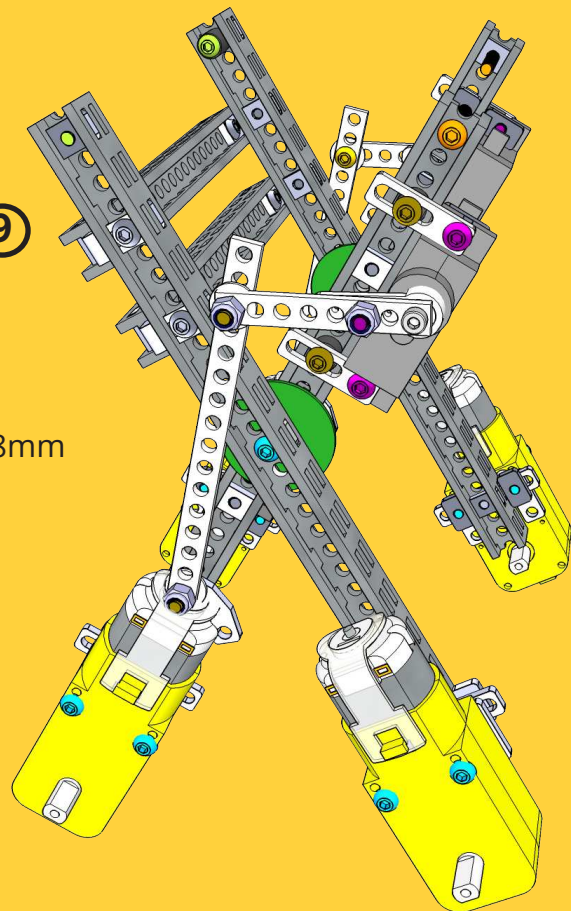

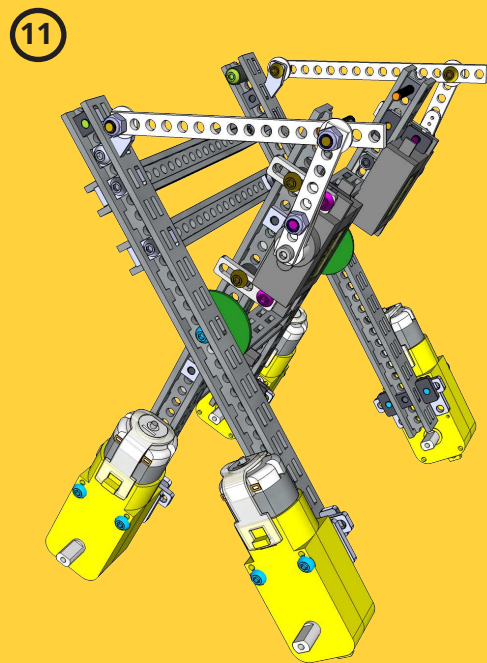
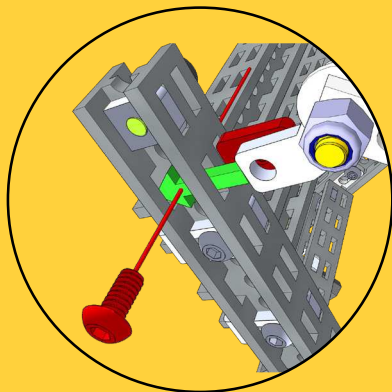
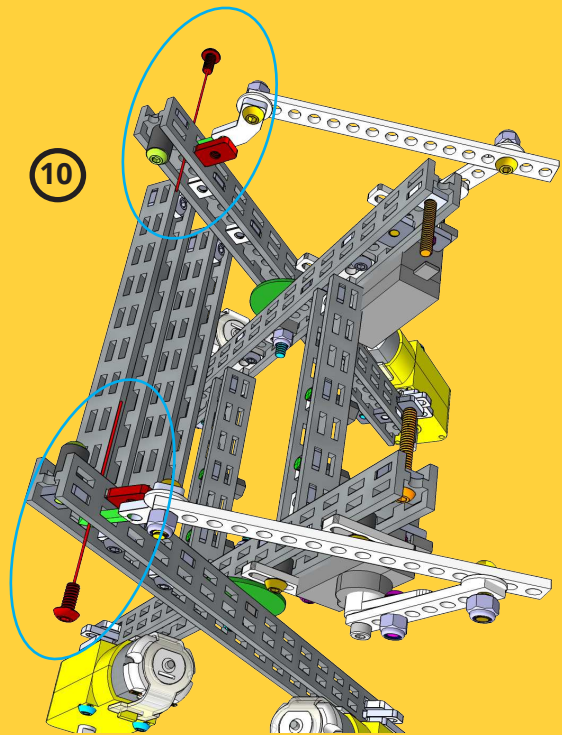







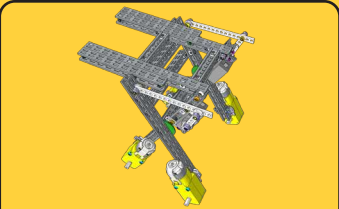





**PART 7**



# PART 8



- 8x  Bolt M3x6
- 4x  Bolt M3x16
- 12x  Nut M3 6x10
- 2x  Lock Nut M3
- 4x  Nylon Spacer 4mm
- 2x  Metal washer M3 9x0.8mm
- 2x  L-Twisted mirrored
- 2x  L-Twisted

	5 cm	2x
	10 cm	2x
	14 cm	2x

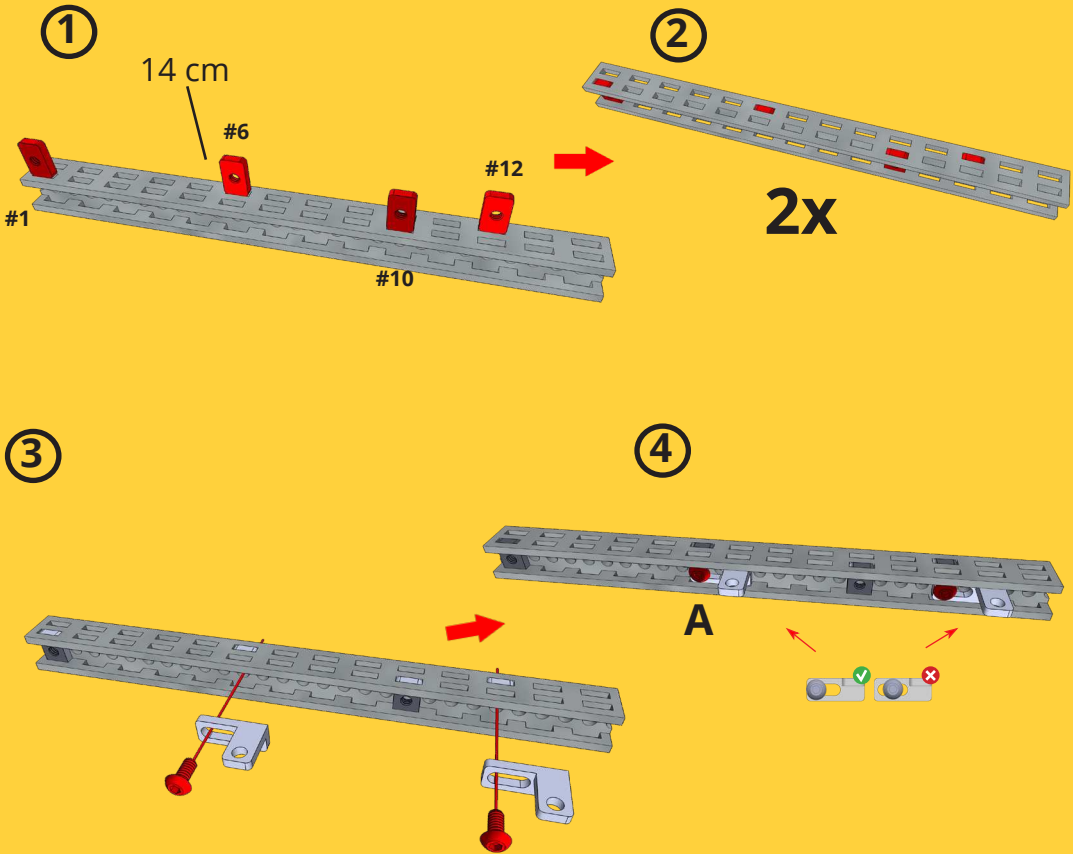

5

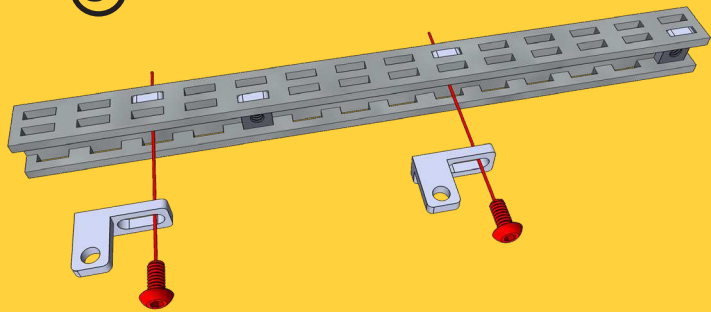

6

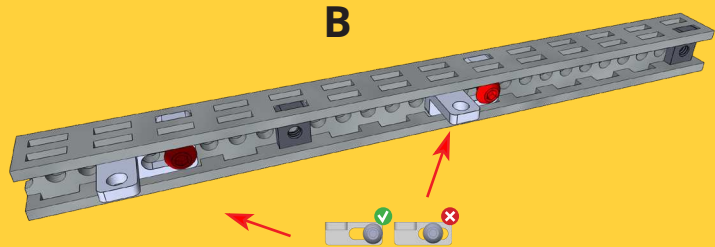

7

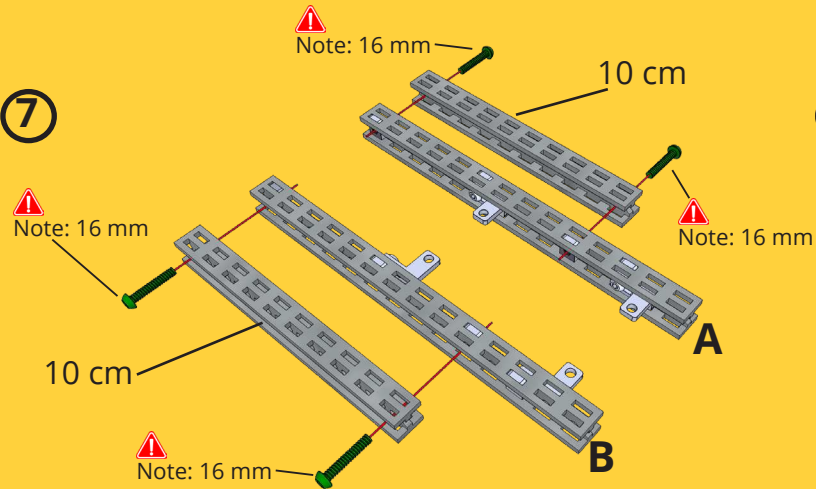

8

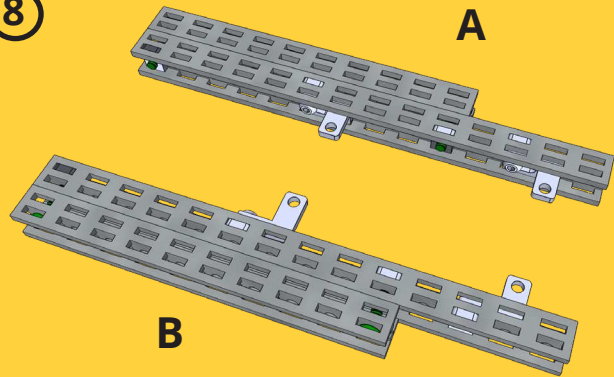

9

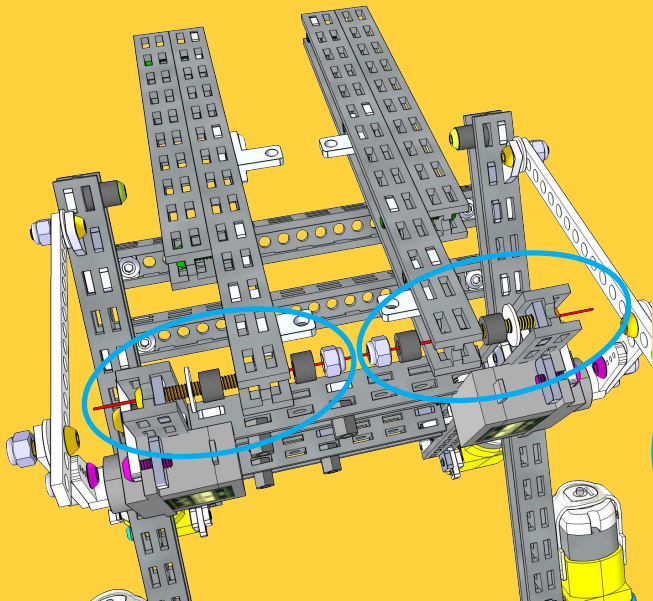

10

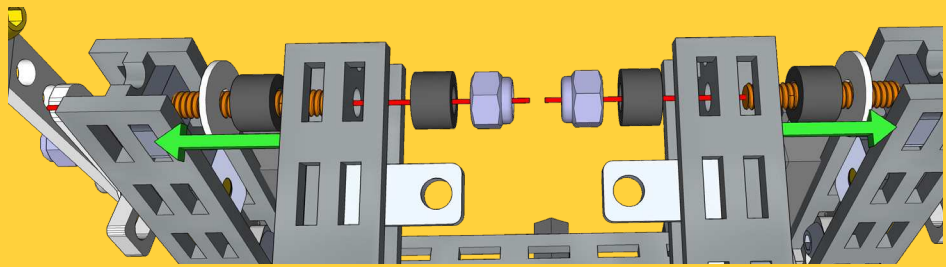
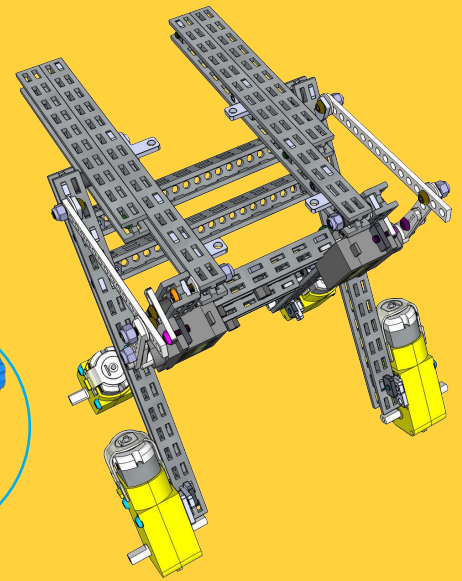

9

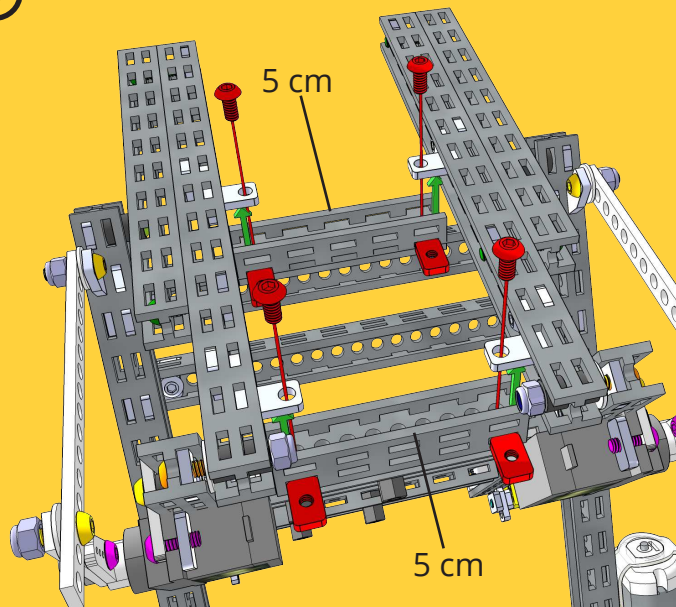

10

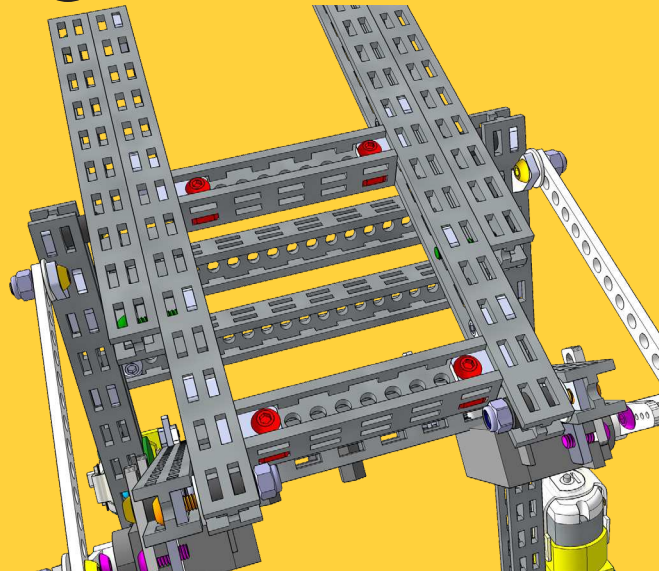

**PART 8**

# PART 9

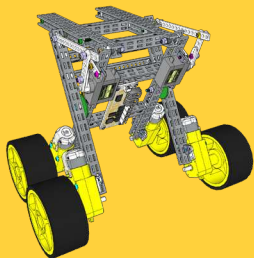

4x



Bolt M3x6

4x



Yellow Wheel D 67mm

1x



X3 Controller Board

①

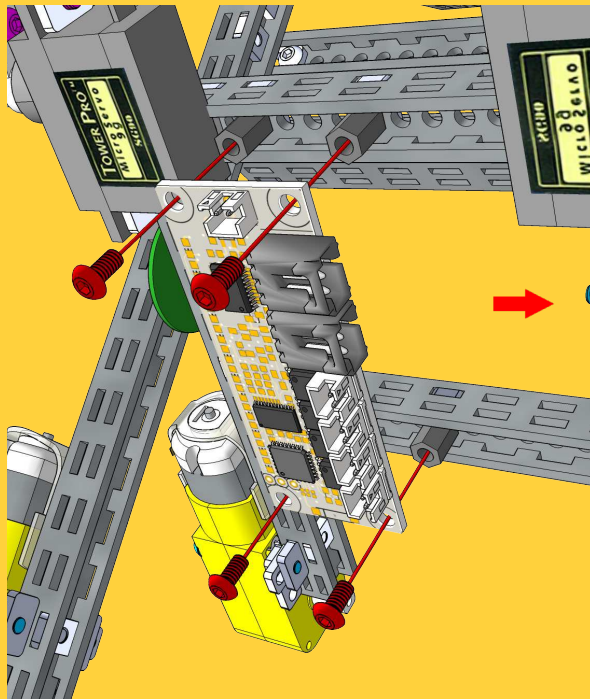

②

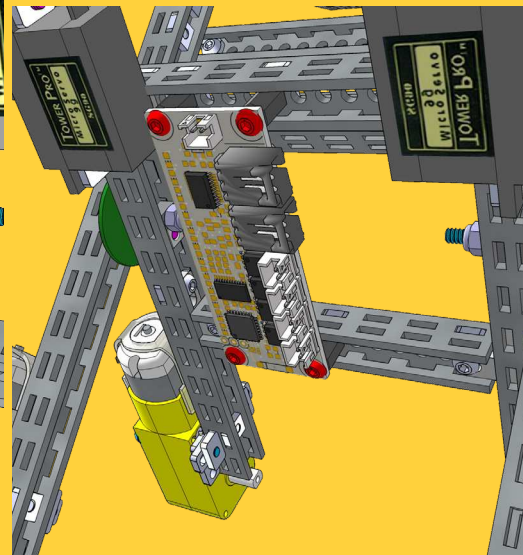

3

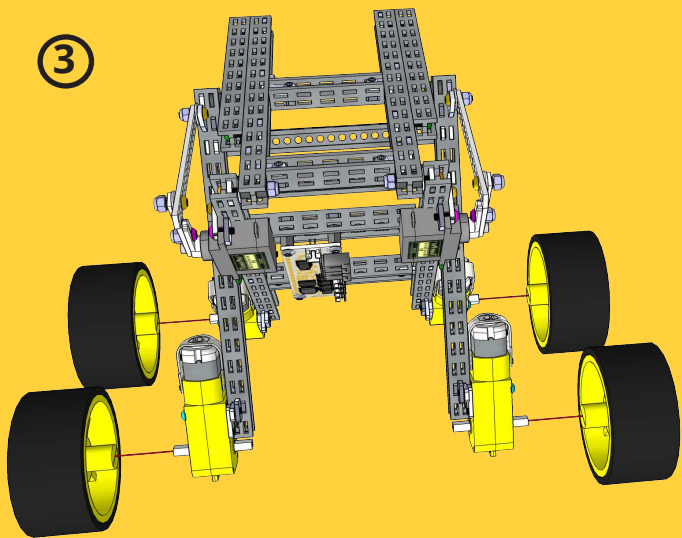

4

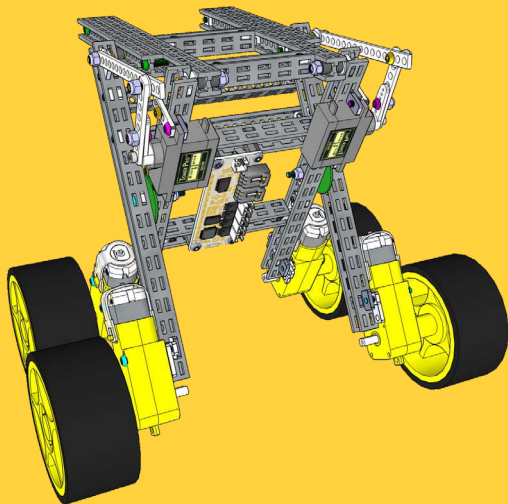

# PART 10



## Cabling and connections.

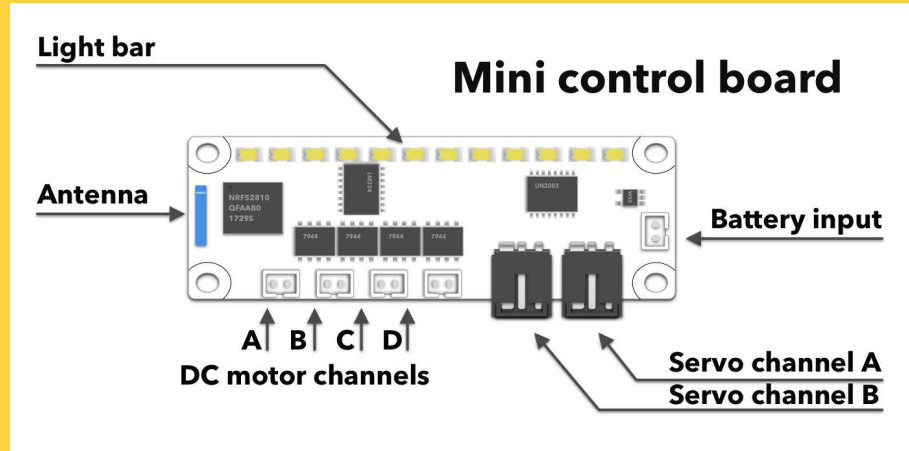

Integrated controller that has Bluetooth connection, 4 DC motor channels and 2 Servo motor channels.

More info here:

<https://totemmaker.net/wiki/x3-fbi-board-set-up/>

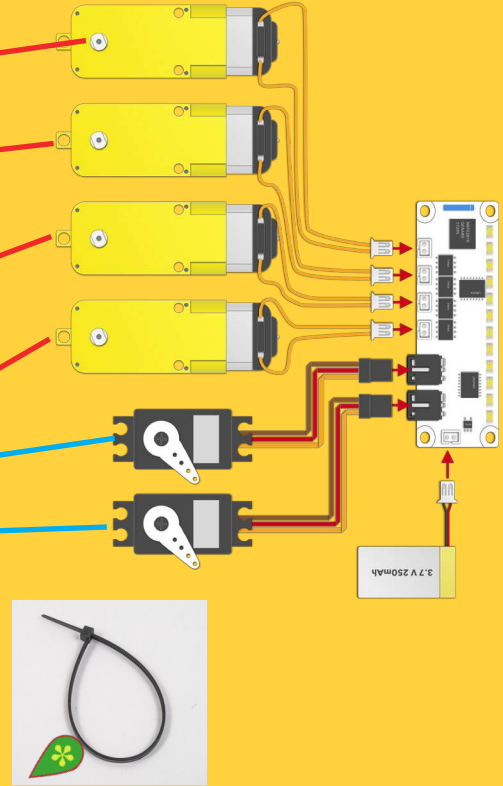
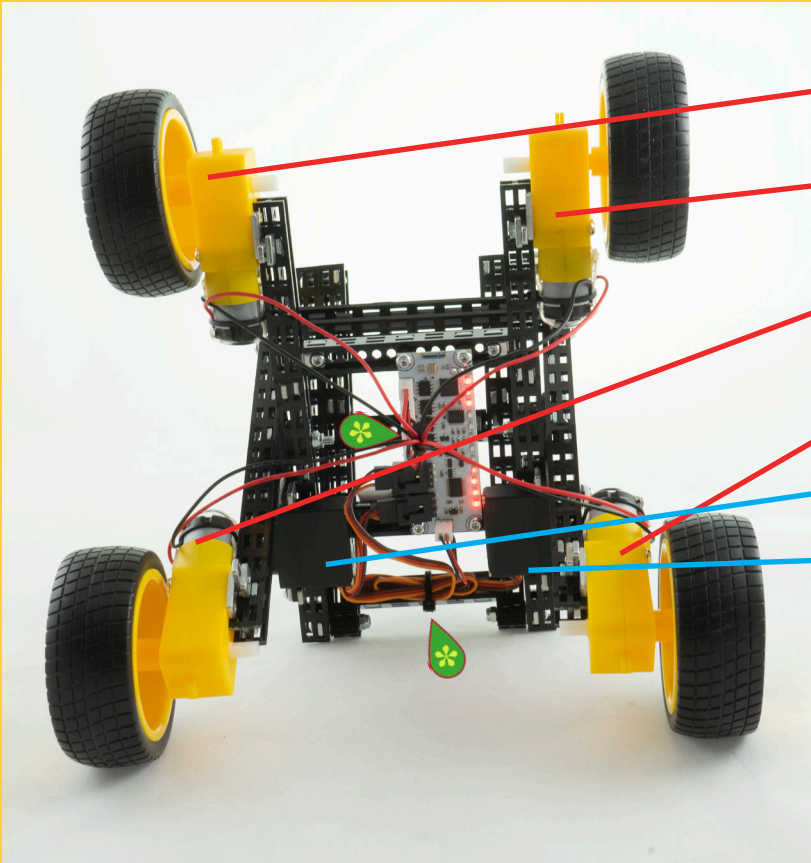



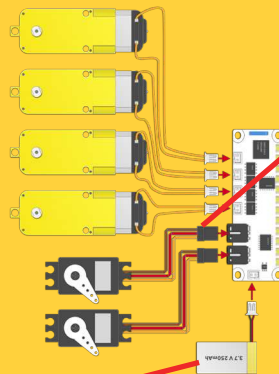
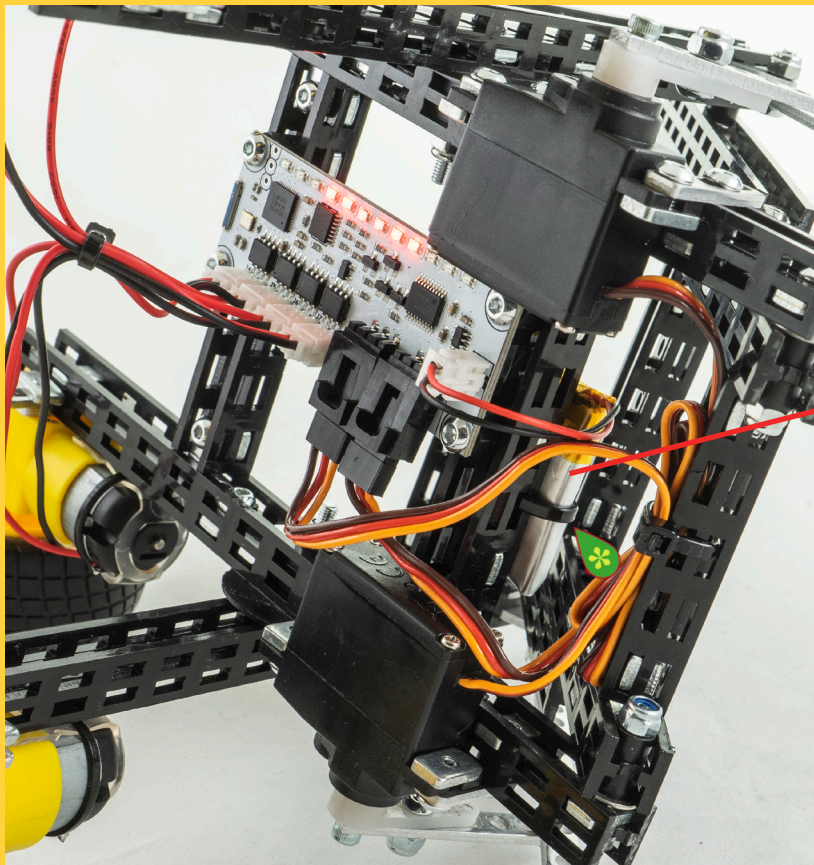

 **Note:**  
**Observe the wires orientation:**  
**Brown, Red and Yellow.**



**Building is finished !**

**Now it is time to test your model.**



**PART 10**



## HOW TO CONTROL

Download Totem app on your smartphone or tablet via App Store or Google Play.

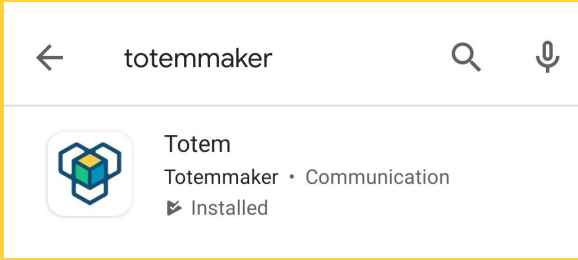

Follow the step by step guide to connect your Ladybug to your device.



Search for:  
**Totemmaker**

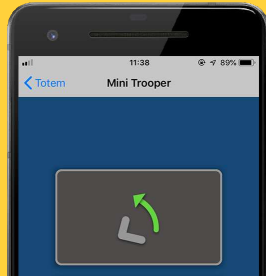

To slow down the rotation speed, press two buttons at the same time. I. e. press both Forward and Right buttons.

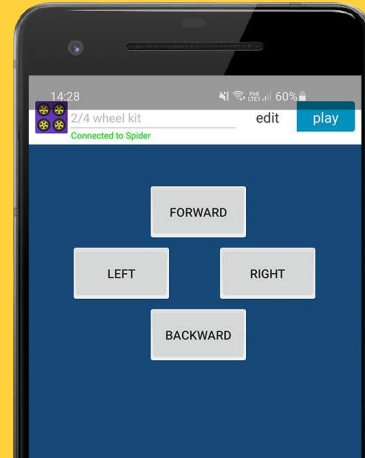



## PRECAUTIONS: ELECTRONICALLY OPERATED PRODUCT

Do not give this product to children aged 8 or below. As with all electronic products, precautions should be observed during handling and use to prevent electric shock.

**Adult supervision required.**

**Note to adults:** to ensure that the child's play is both safe and fun, please review all operating instructions and safety rules with your child.

### SAFETY WARNINGS:

- Do not pick up toy while in motion.
- Keep fingers, hair, and loose clothing away from moving parts, to avoid the injury.
- Adult supervision is required when this toy is being operated.
- If you stopped operating the toy, remember to unplug the battery, to avoid accidental operation.
- If the toy is dirty, please clean it with dry and soft cloth. Do not clean electronics.
- Do not expose the toy to high temperature, high humidity, or direct sunlight.
- Indoor use only. Do not put this product in water to avoid damaging its electronic components.
- The product is made of complex electronic circuit and electronic components, do not disassemble, or modify the circuit board.

### BATTERY SAFETY INFORMATION:

- This toy is designed to work with provided 250 mAh 3.7V LiPo battery and charger.
- Rechargeable battery must be charged by adult only.
- Do not leave charging without supervision of adult.
- There is a risk of fire and personal injury if battery is punctured, damaged or misused.
- Do not disassemble or damage the battery pack.
- Use only the supplied 250 mAh 3.7V LiPo battery. Using any other battery may damage the model.
- Use only the included USB charging cable to charge the battery.
- Please check on a regular basis the wire, plug, battery, charger, and other electronic parts on the toy. If any damage is found, please stop using the product immediately.
- Stop charging if battery becomes hot, smells, smokes or gives off strong odour.
- Never throw batteries into fire to avoid explosion or leakage.
- Check the batteries on regular basis to avoid leakage.
- Recycle or dispose of batteries according to local laws and guidelines.

## BATTERY CHARGING:

### Rechargeable battery must be charged by adult only.

- The new battery pack needs to be charged before use.
- Connect the USB charging cable to 5V USB power source, such as laptop.
- Connect the battery to the charger (see picture on the left). The charger will show a red LED light when charging the battery. When the battery is fully charged, the red LED light turns off.
- To disconnect cables, hold the connectors of both cables and pull apart (see picture on the right).
- Do not attempt to overcharge the battery.

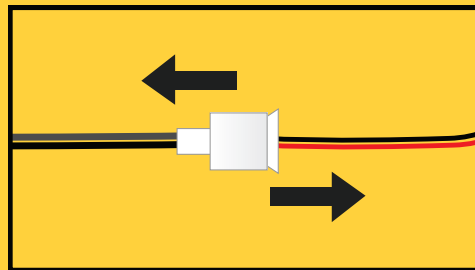
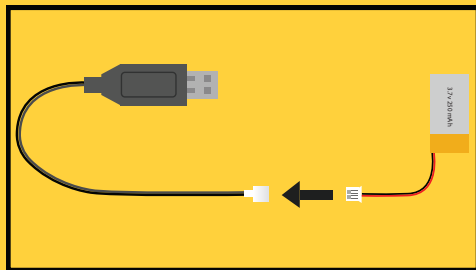

KEEP THIS INSTRUCTION MANUAL AND THE PRODUCT BOX AS IT CONTAIN IMPORTANT INFORMATION FOR FUTURE REFERENCE.

Due to the continuous product improvement, the pictures on this manual may differ slightly from the actual product. Please adhere to actual product instead.

Totem Maker names and logos are registered trademarks. All rights reserved.

[www.totemmaker.net](http://www.totemmaker.net)  
Totem Technology, UAB  
Saulėtekio al. 15-709, Vilnius, 10224, Lithuania  
For customer support please contact: [support@totemmaker.net](mailto:support@totemmaker.net)

 **WARNING:**  
CHOKING HAZARD - Small parts.  
Not for children under 3 years.



# Discover more of Totem:

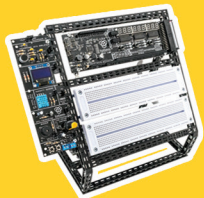

Mini Lab

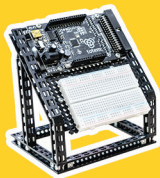

Micro Lab

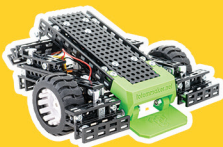

Mini Trooper



Young Engineer Kits



4WD Car Kit

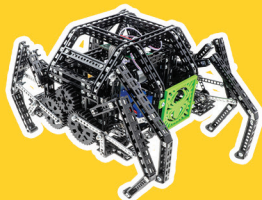

Spider

# Find us here:

 @totemaker

 totem\_maker

 totemmaker

 @totemaker

And tag us in your post  
with **#totemaker**

[www.totemaker.net](http://www.totemaker.net)