

totem

Mini Lab

Assembly and short user guide



WIKI
for tips
and tricks



PARTS LIST

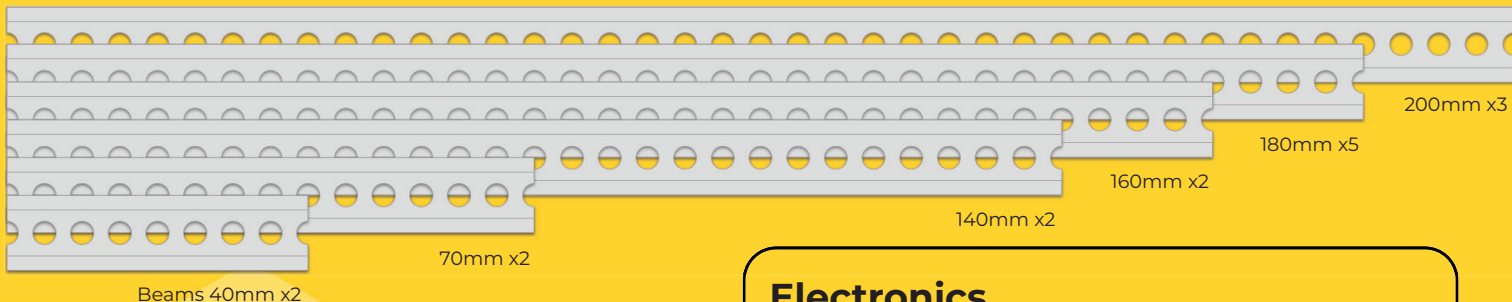

Mechanics



Bolt M3 6mm, x72

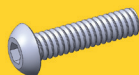

Bolt M3 12mm, x8



Nut M3 6x10, x64



Nylon nut M3, x16



Standoff M3 8mm, x16



2-hole simple bracket, x6



Single side filler, x6



C-bracket, x12



2-hole 45 simple bracket, x6



L-twisted adjustable bracket, x8



L-twisted adjustable mirror bracket, x8

Electronics

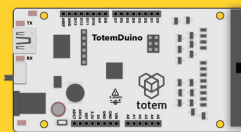

TotemDuino board

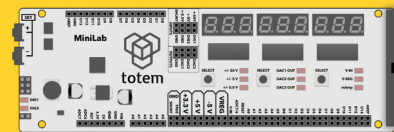

LabBoard

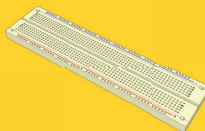

Breadboard SYB-120, x2

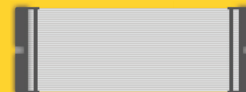

Flat cable, 30cm



Totem Screwdriver



Breadboard cable kit x2



USB cable

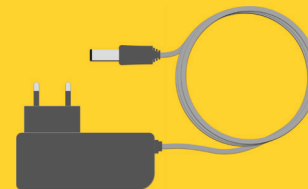

Power adapter

Assembly tips

- The included magnetic Totem screwdriver can be used to assemble the model.
- Do not use too much force when tightening the bolt – sometimes you need to adjust brackets during assembly.
- Each step contains a list of parts needed – it helps if you prepare them beforehand.
- Zoomed-in view gives a detailed peek into more difficult pieces.

Please carefully read all instruction manual prior using the product. Keep this instruction for future reference: they contain important information.

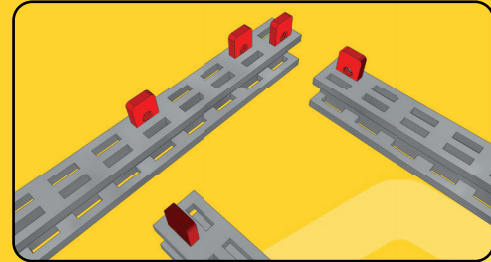

Start by putting nuts in their correct positions.

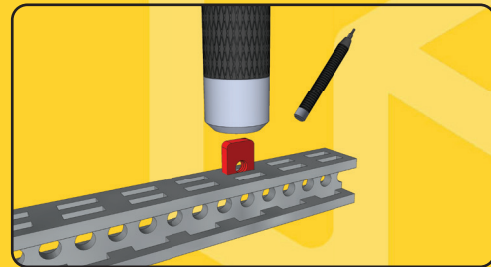



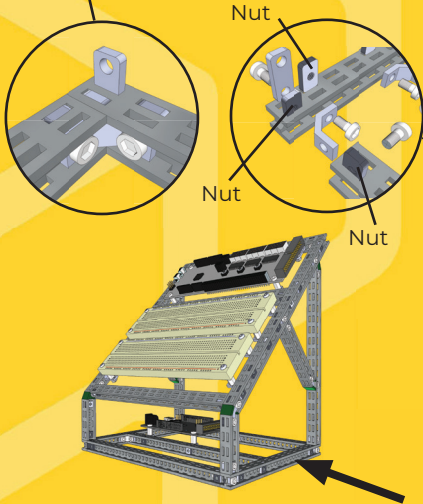
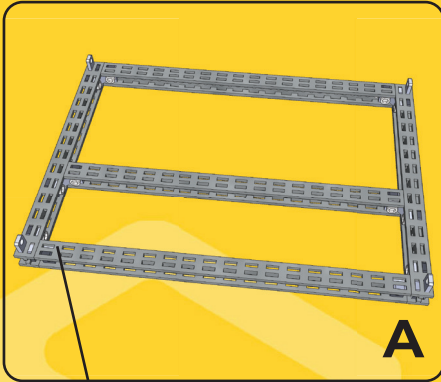

Back of the Totem screwdriver helps to push nuts into their place.

1



6x 16x 4x 16x



C-bracket Bolt M3 6mm 2-hole simple bracket Nut M3 6x10

Beams: 2 x 14cm, 3 x 18cm

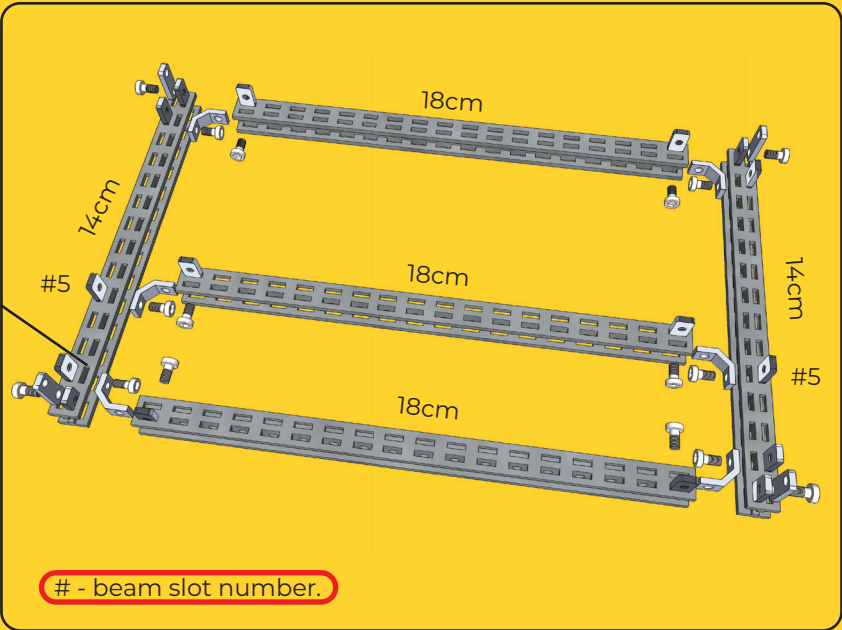

2

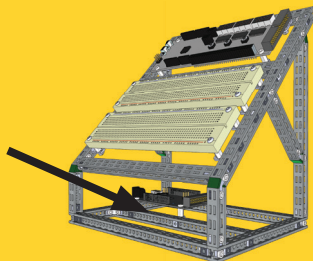
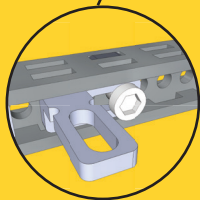
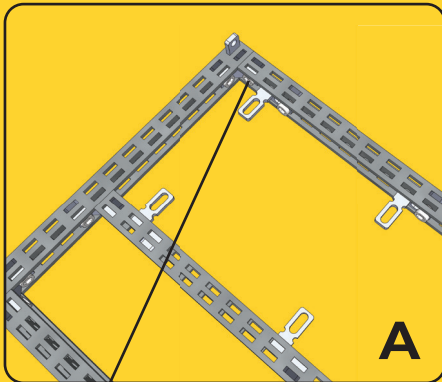

2x L-twisted adjustable bracket

2x L-twisted adjustable mirror bracket

4x Bolt M3 6mm

4x Nut M3 6x10

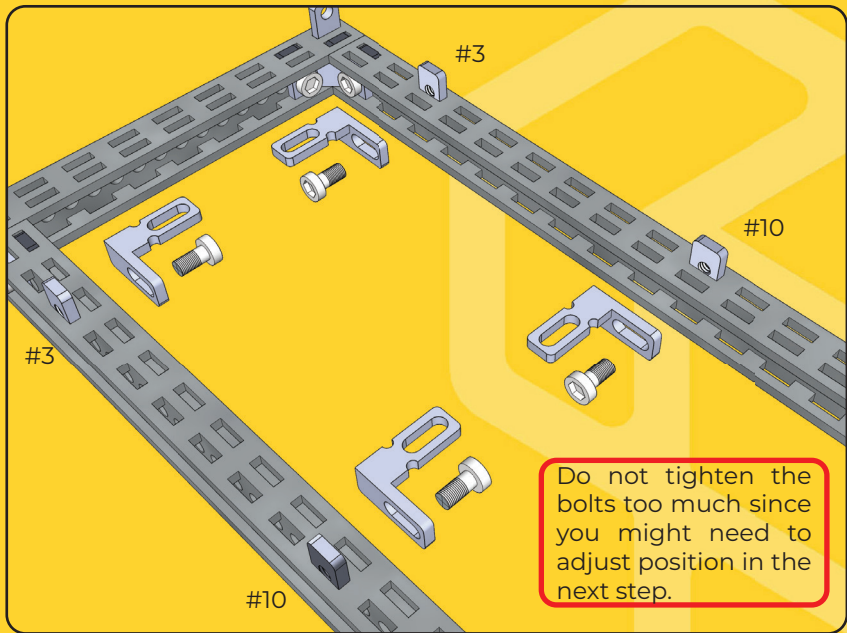

3

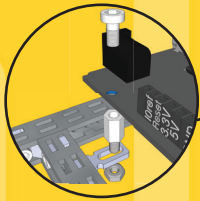
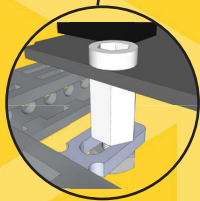
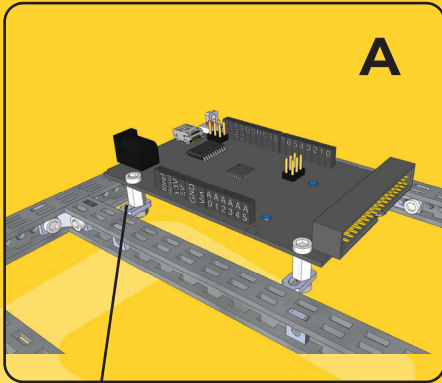

Use these 4 holes:

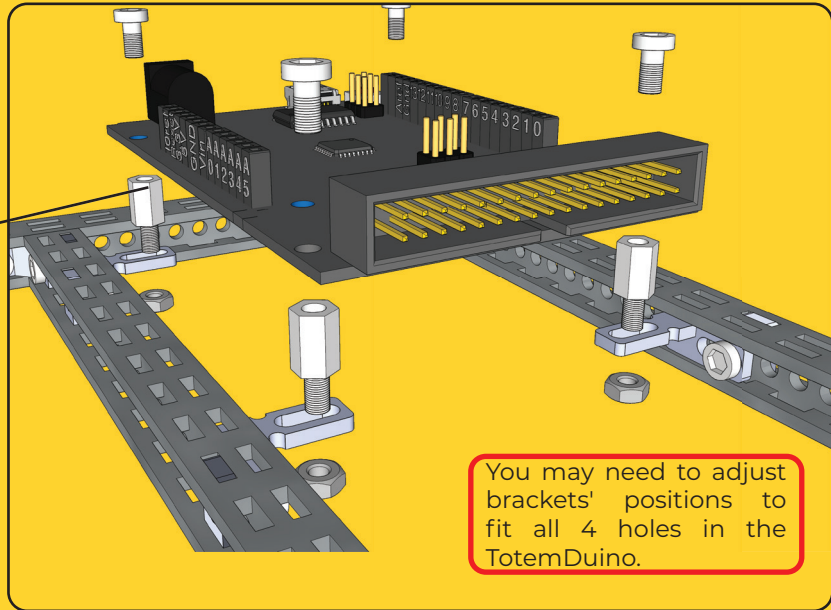
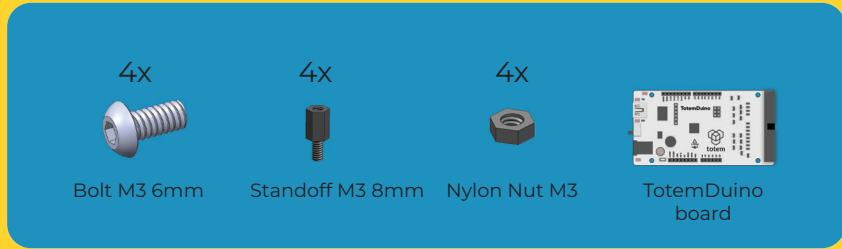
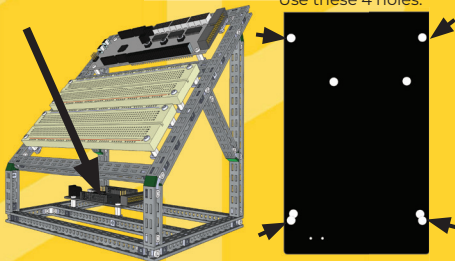

4

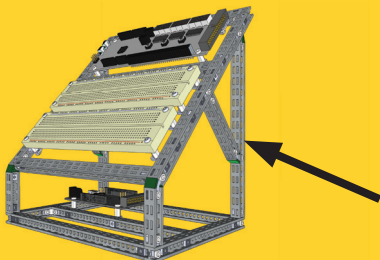
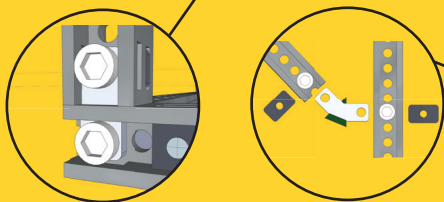
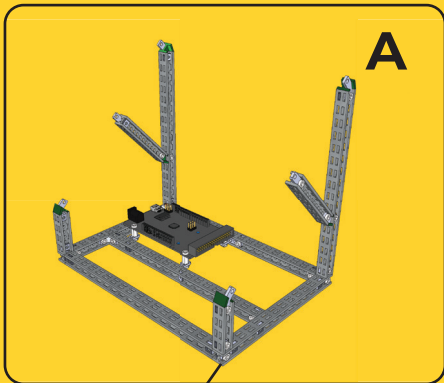

6x
2-hole 45
simple
bracket



2x
2-hole simple
bracket



14x
Bolt M3 6mm



14x
Nut M3 6x10



6x
Single side
filler

Beams: 2 x 4cm, 2 x 7cm, 2 x 16cm

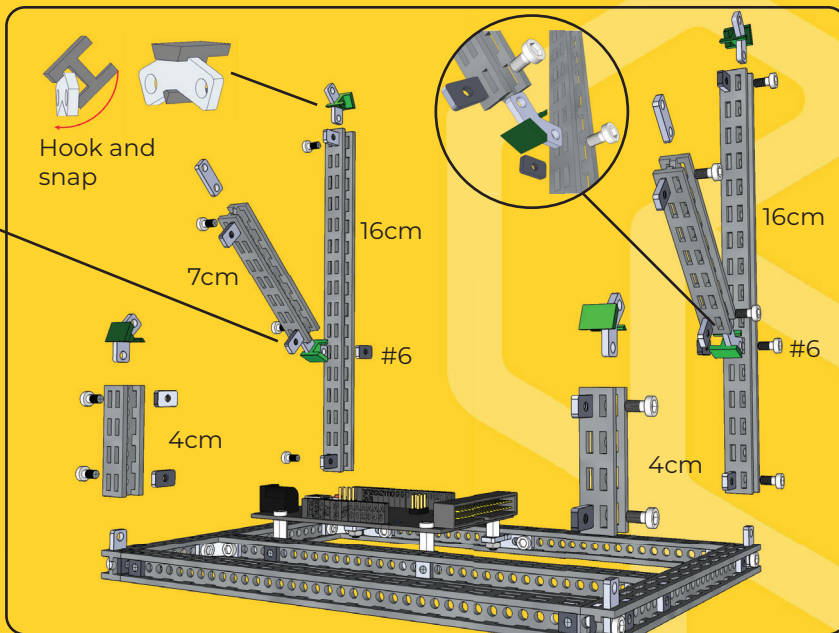

5

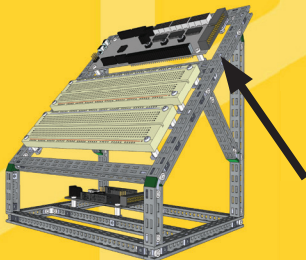
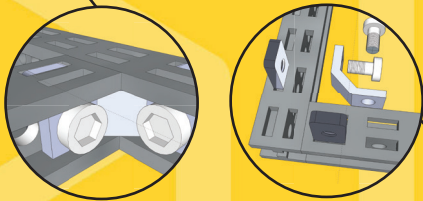
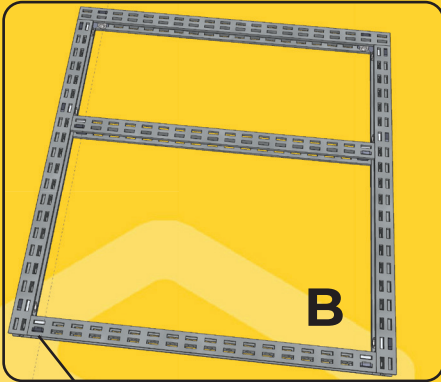

12x



Bolt M3 6mm

12x



Nut M3 6x10

6x



C-bracket

Beams: 3 x 20cm, 2 x 18cm

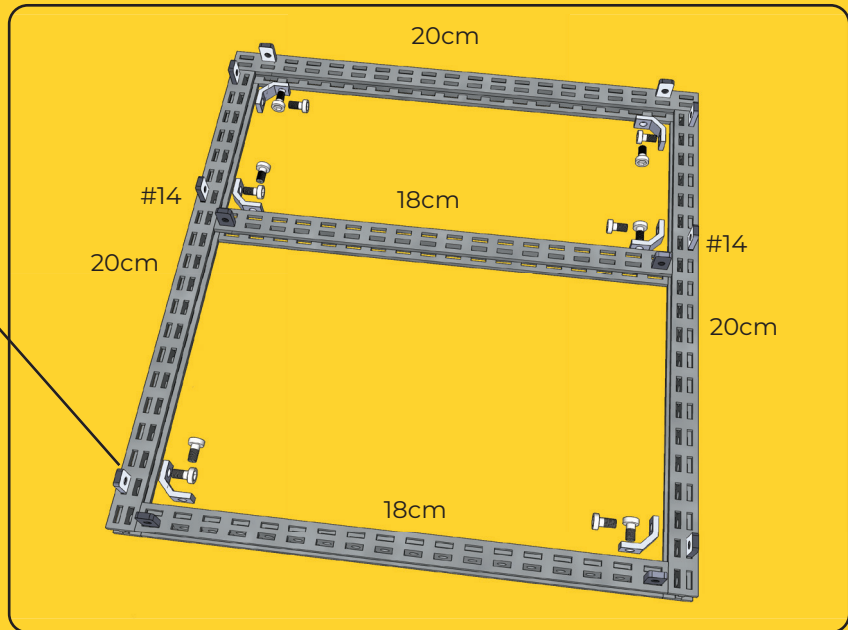

6

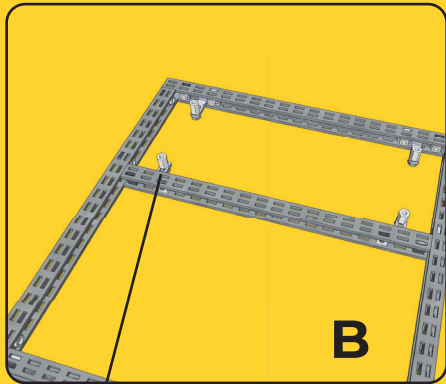

B

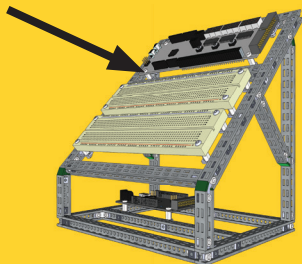
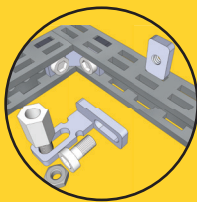
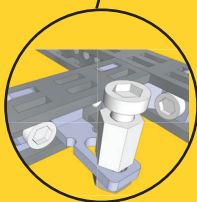

2x	2x	4x	4x	4x	4x
L-twisted adjustable bracket	L-twisted adjustable mirror bracket	Standoff M3 8mm	Nylon Nut M3	Nut M3 6x10	Bolt M3 6mm

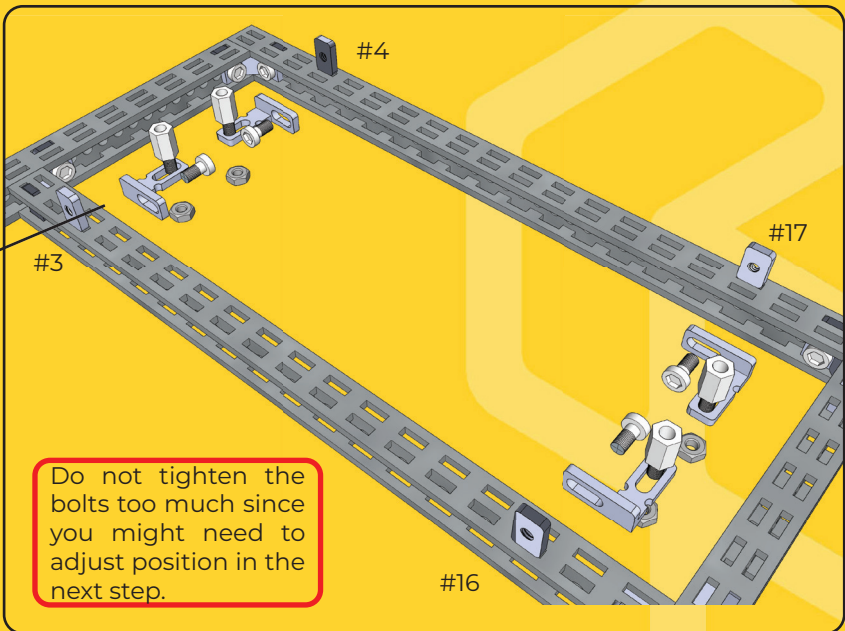

Do not tighten the bolts too much since you might need to adjust position in the next step.

7

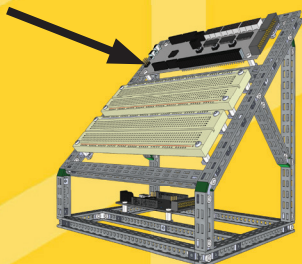
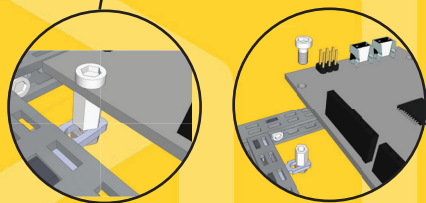
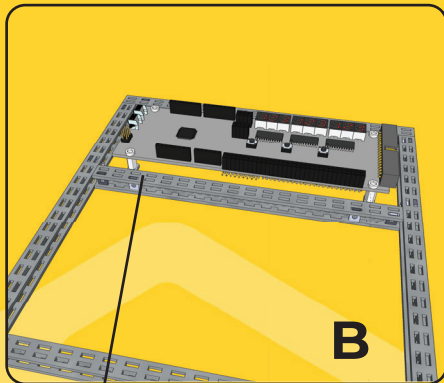

Bolt M3 6mm

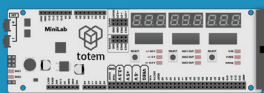



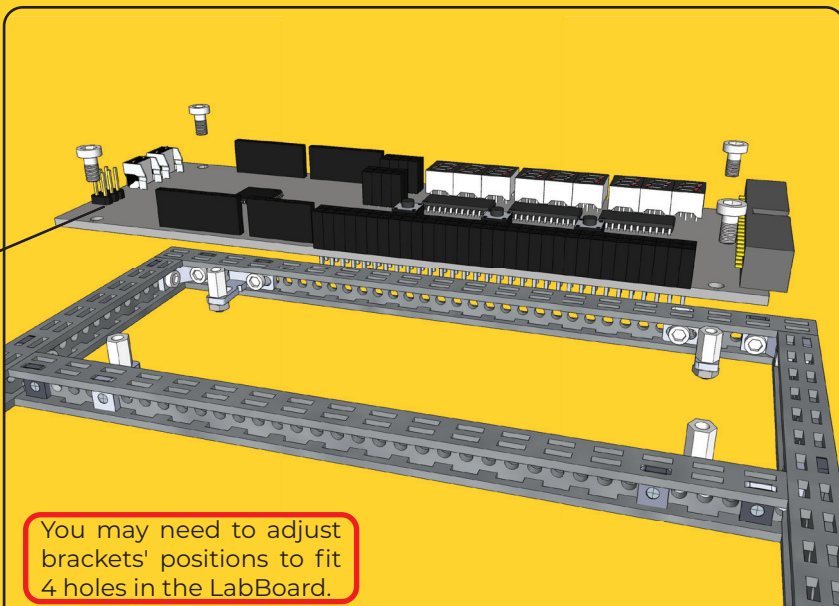



LabBoard

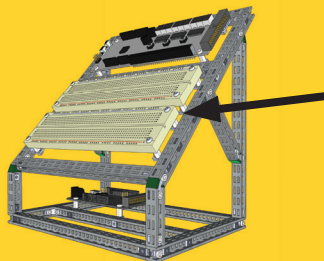
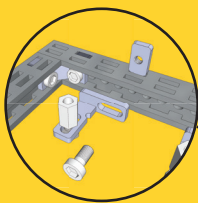
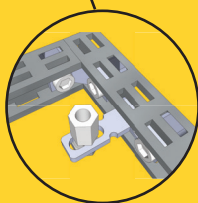
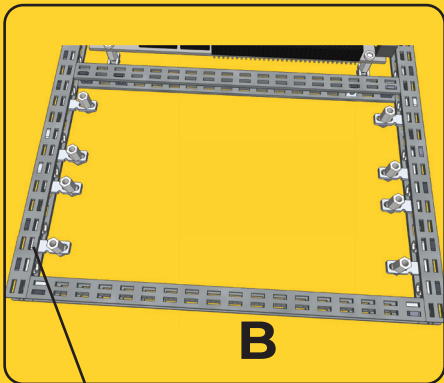

You may need to adjust brackets' positions to fit 4 holes in the LabBoard.

8



4x	4x	8x	8x	8x	8x
					
L-twisted adjustable bracket	L-twisted adjustable mirror bracket	Standoff M3 8mm	Nylon Nut M3	Nut M3 6x10	Bolt M3 6mm

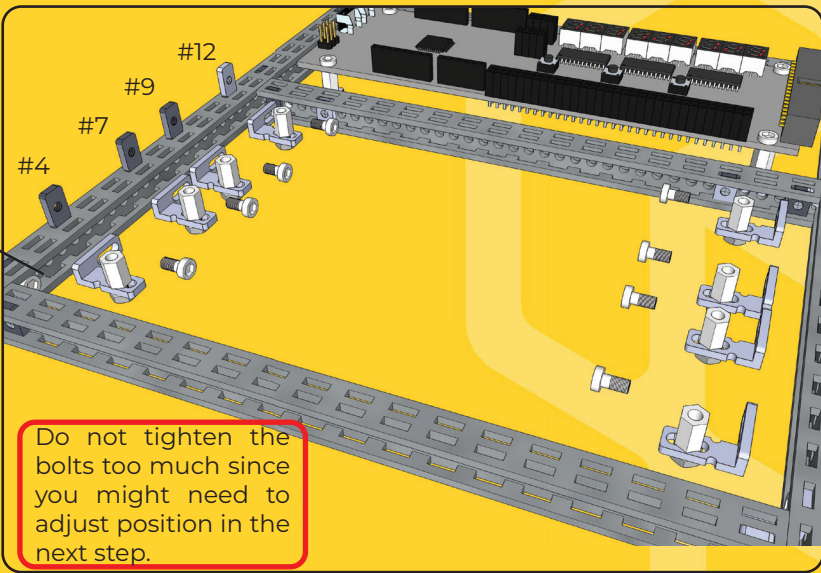

9

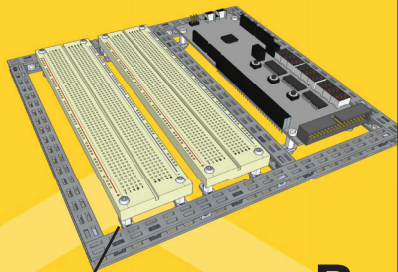

B

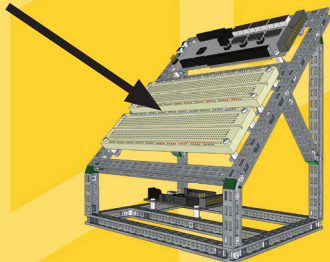
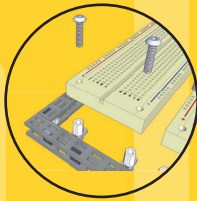
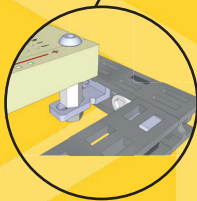

8x
Bolt M3 12mm

2x
Breadboard
SYB-120

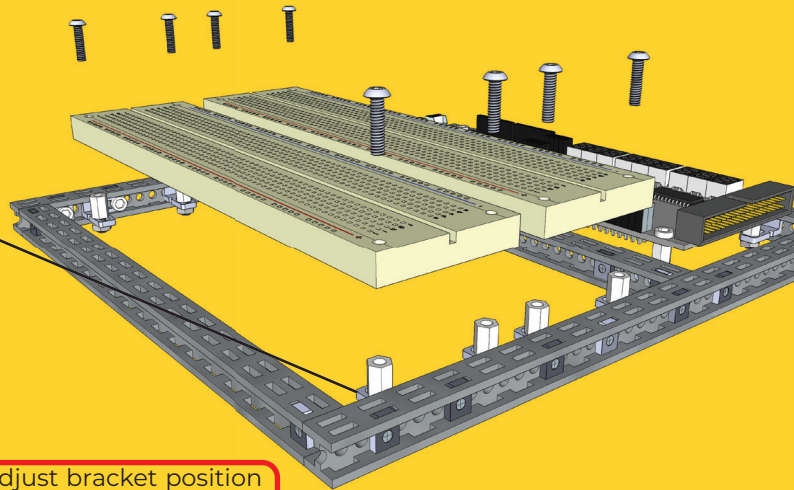

Adjust bracket position
to fit the holes on the
breadboards.

10

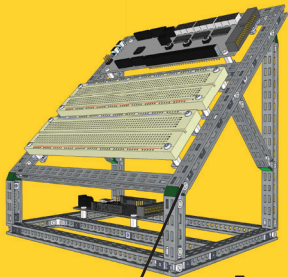

A + B

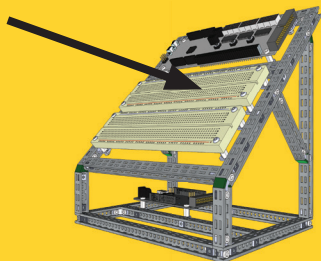
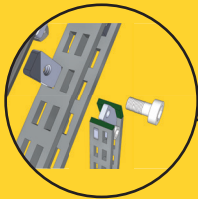
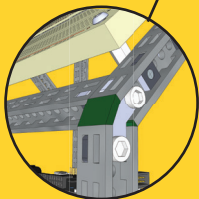

6x
Nut M3 6x10



6x
Bolt M3 6mm

Sub assemblies A and B

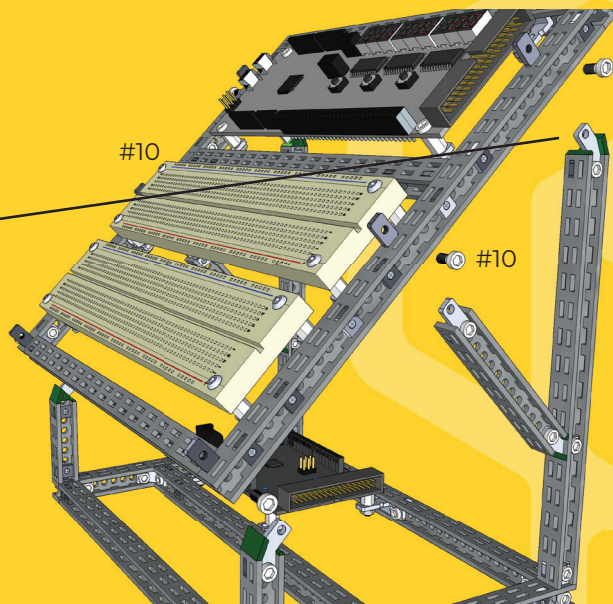

FINAL STEP Attaching the flat cable.



Flat cable, 30cm

Attach the flat cable to the TotemDuino like this.

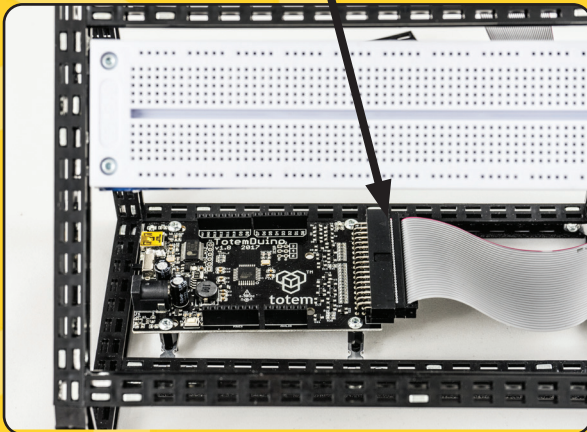

Loosen the bolts on the LabBoard for better cable reach.

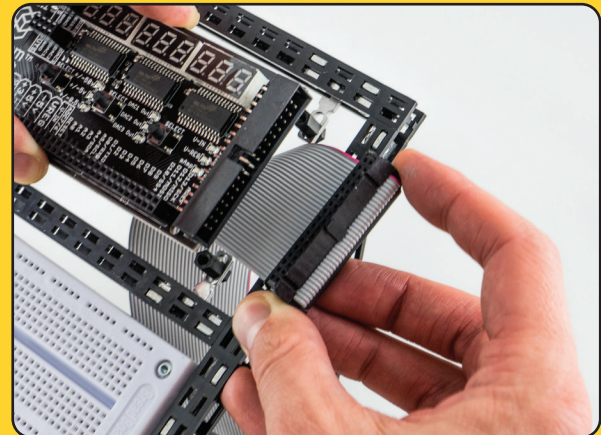

Short User Guide 1. Overview

Set buttons, changing value for the selected parameter.

Input and Output connectors.

Display with mode select buttons — LED indicates currently measured value.

TotemDuino connection.

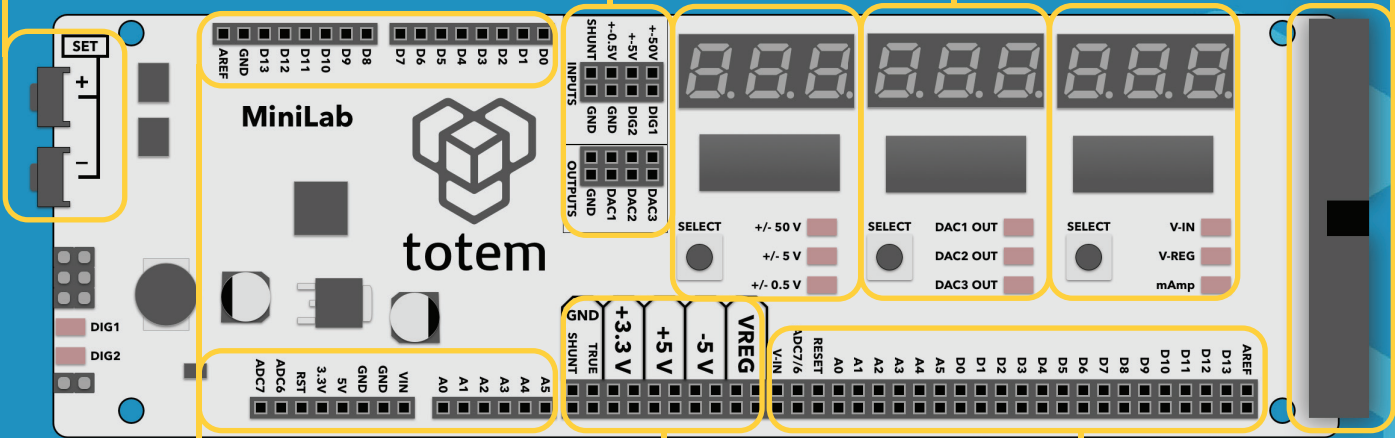

TotemDuino ports, compatible with Arduino shields and headers.

Output power connectors.

TotemDuino ports in a breadboard friendly arrangement.

2. TotemDuino Overview

Mini USB connector for sketch uploading into TotemDuino.

TotemDuino is based upon Arduino Uno platform, keeping compatibility with existing IDE's and expansions, while offering following advantages.

Voltage selector switches between 3.3V or 5V.

Power input accepts any voltage between 9V to 20V. At least 1A power supply is recommended.

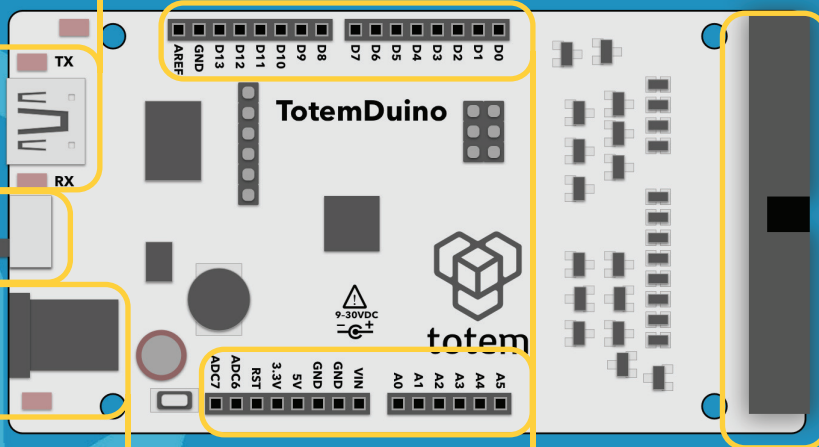

Connection to TotemDuino. All pins going out are protected against short circuit or overvoltage conditions, giving extra safety.

TotemDuino ports, compatible with Arduino shields and headers.

3. Voltage measuring

Display shows currently selected channel measurement result in Volts.

Display blinks when negative voltages are measured.

Three input channels available:
+0.5V
+5V
+50V

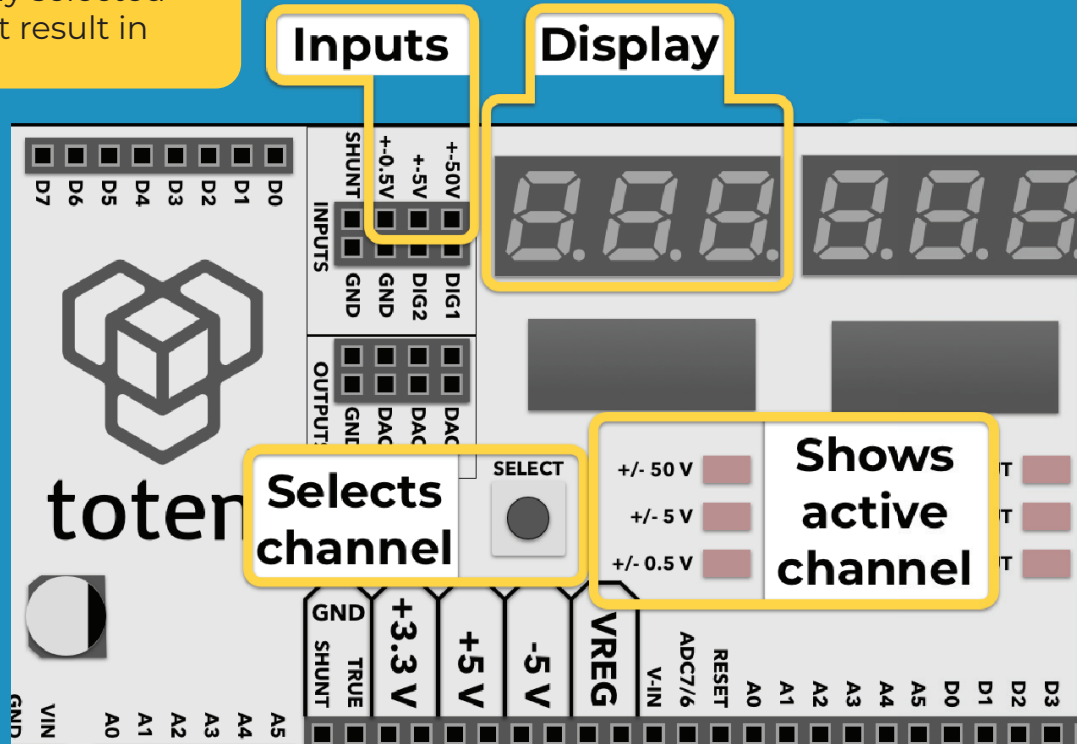

Inputs

Display

Selects channel

Shows active channel

4. Setting output voltage

To set output voltage, hold **SELECT** button for 2 seconds and adjust the output with **SET+** and **SET-** buttons.

Display

Currently active channel output is shown on display.

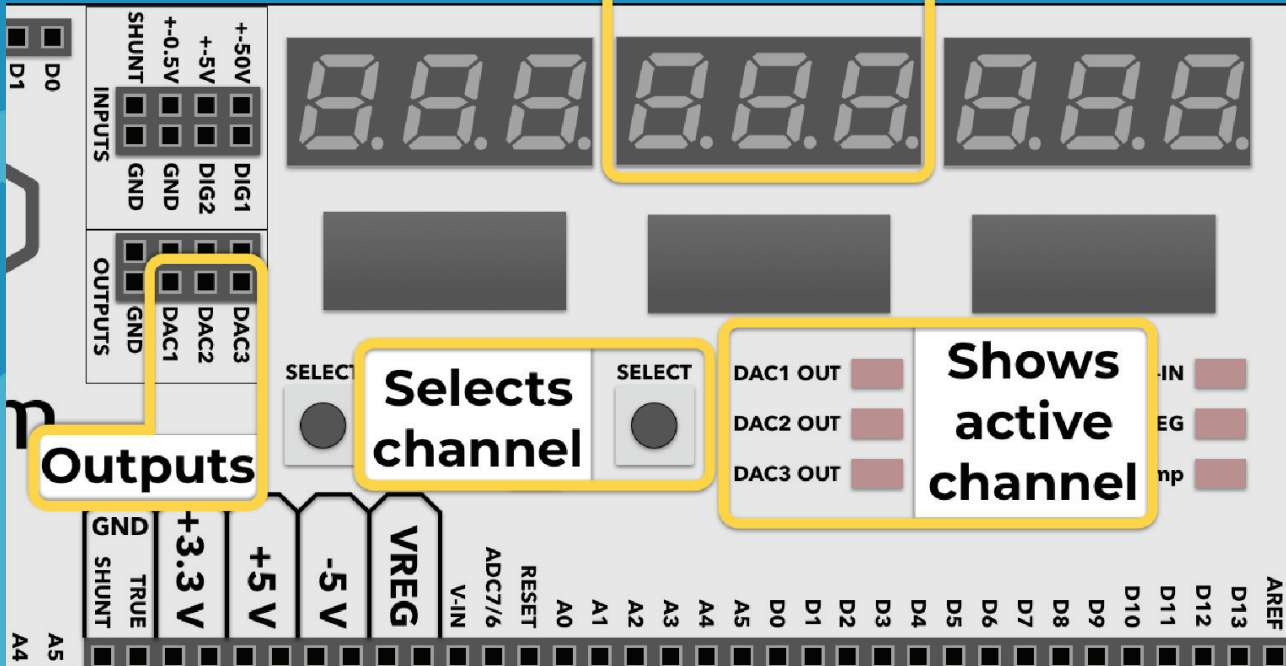

5. Digital inputs

DIG1 and **DIG2** LEDs follow the digital input state level.

Use this to observe any digital signal state in the 3.3V or 5V range.

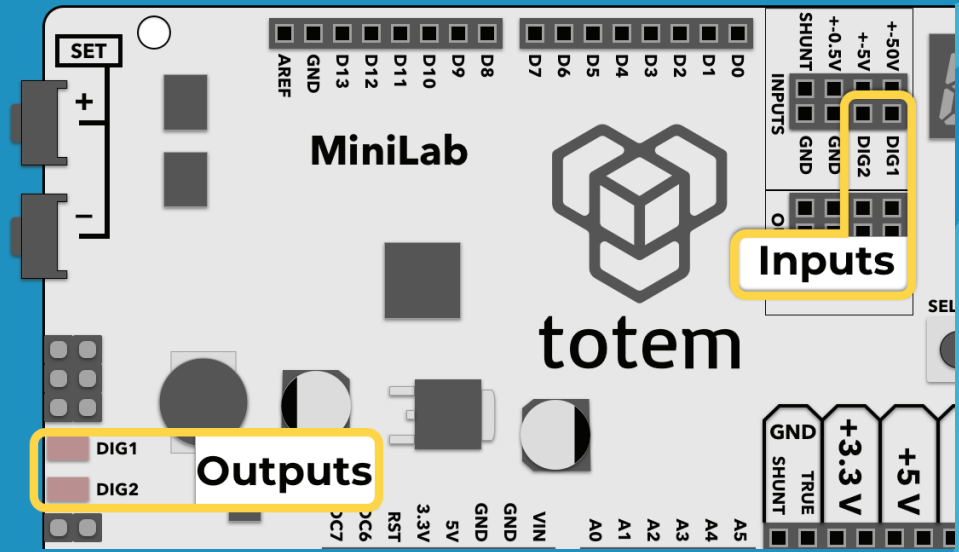

6. Frequency measuring

To enter or exit frequency measure module, push **STEP-** button for 2 seconds.

DIG1 input is used for frequency measuring and can work with digital signals in 3.3V or 5V range, up to 750kHz.

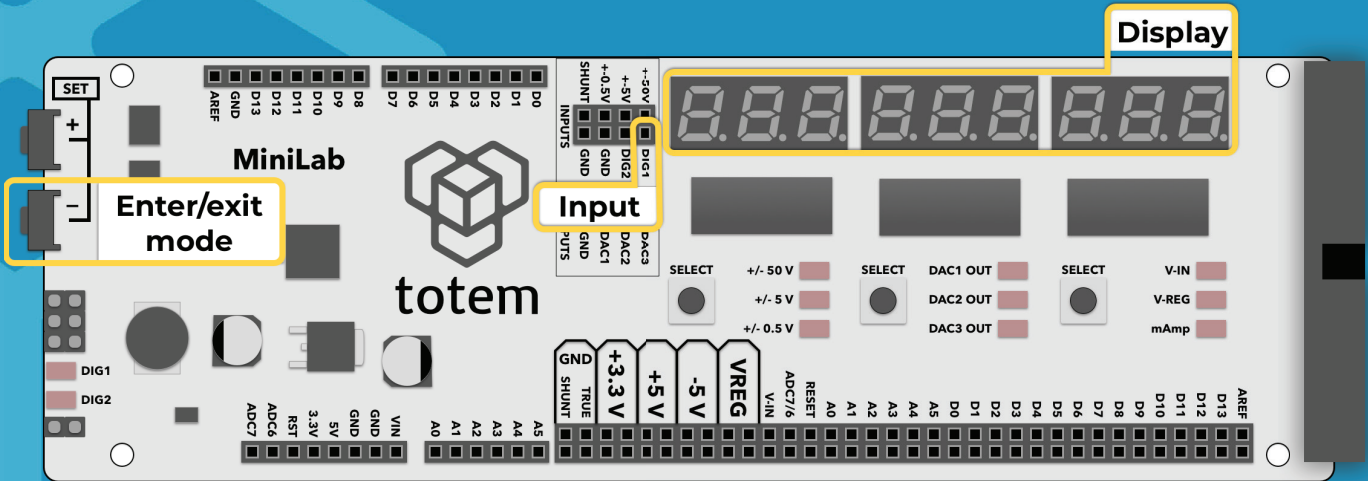

7. Measuring current consumption

Use a test lead to connect mode jumper inputs together.

Use right **SELECT** button to switch into current measuring mode, marked as mAmp.

Your supply ground pin should be connected to this shunt ground input.

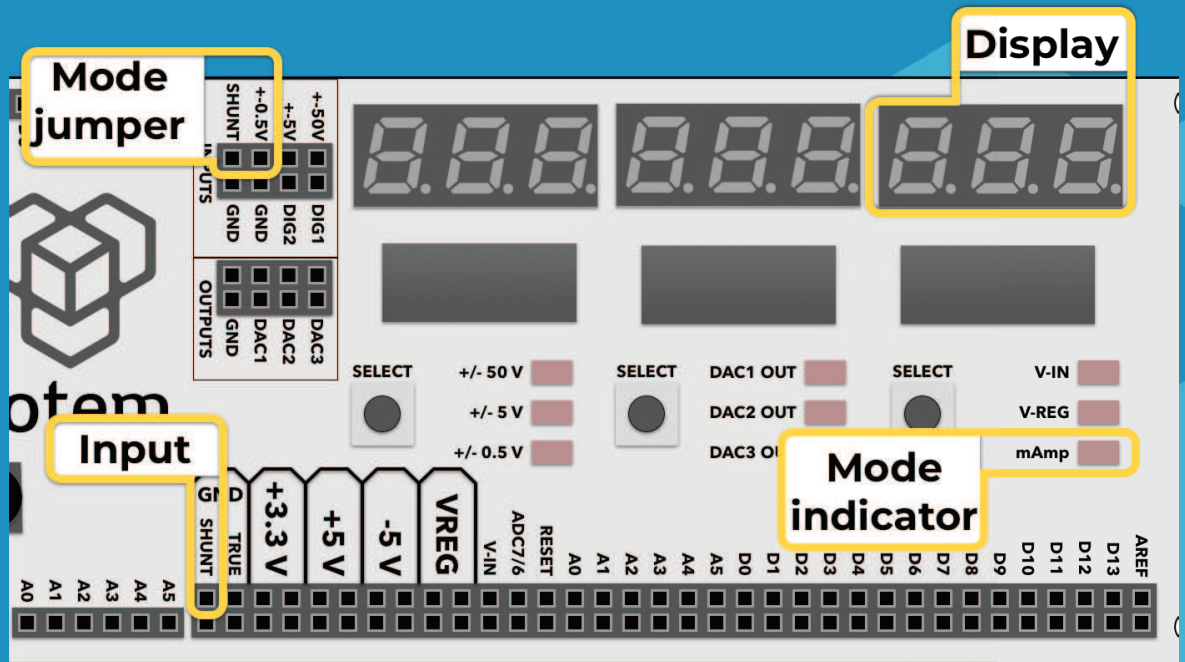

8. Using programmable power supply

Adjust the output with **SET+** and **SET-** buttons, current value will be shown on display.

Use right **SELECT** button to switch into voltage set mode, marked as V-REG.

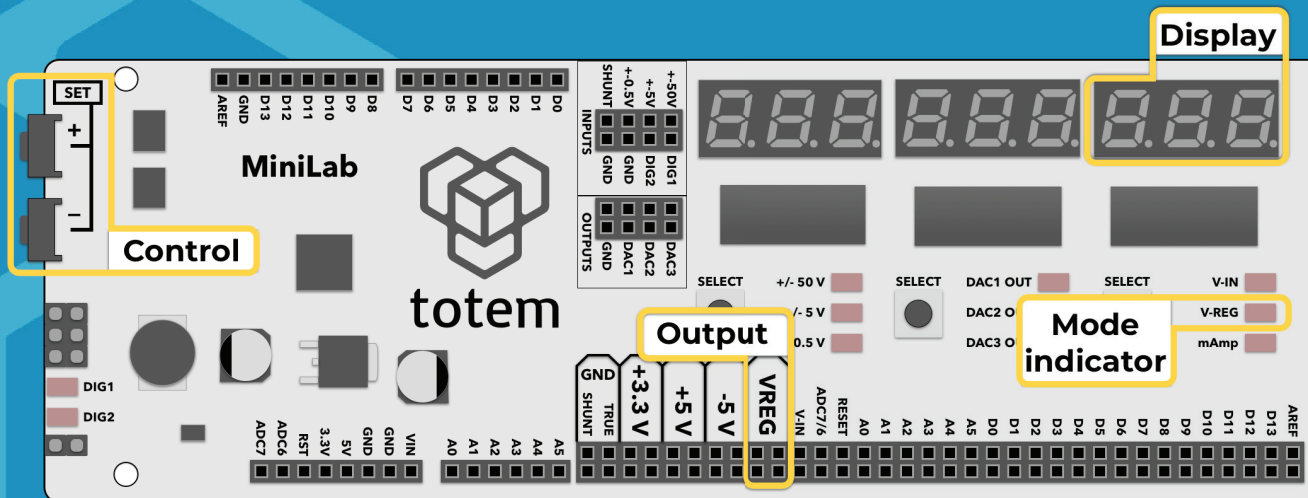

9. Using pulse counter

Can count digital signal pulses up to 750kHz. Signal must be in either 3.3V or 5V range.

Hold **SET+** button for 2 seconds to enter or exit this mode.

Left **SELECT** button resets counter value back to zero.

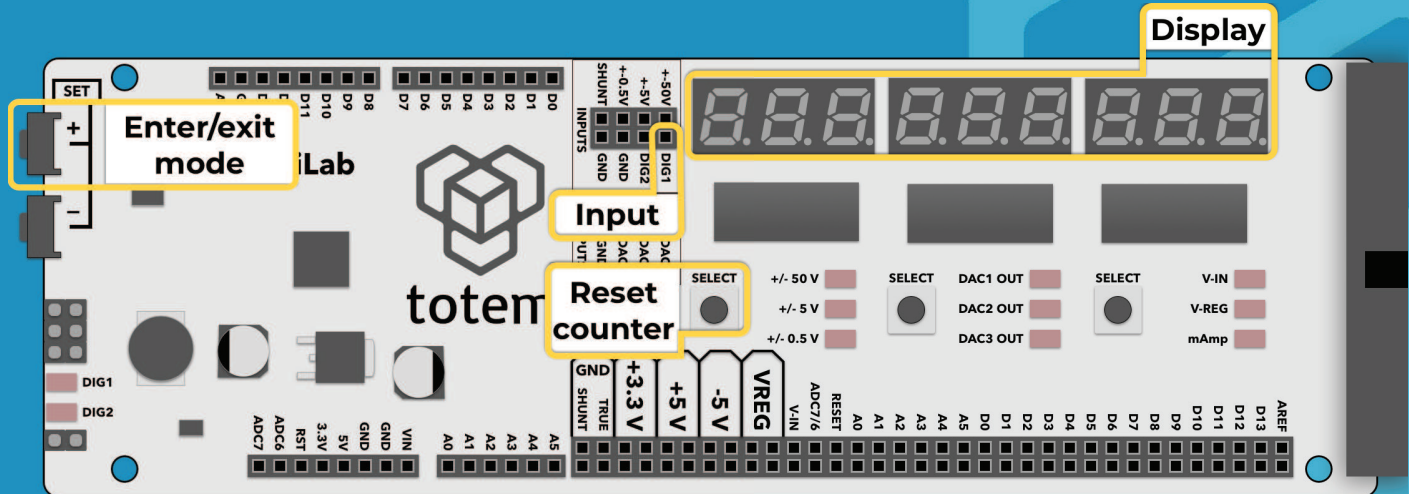

10. Pulse generator module

Can be used to generate digital signals with programmable pulse width and period. Supports either continuous or numbered pulse generation.

For complete usage manual, refer to the **Mini Lab** user guide.

Hold left **SELECT** button to enter into this mode.

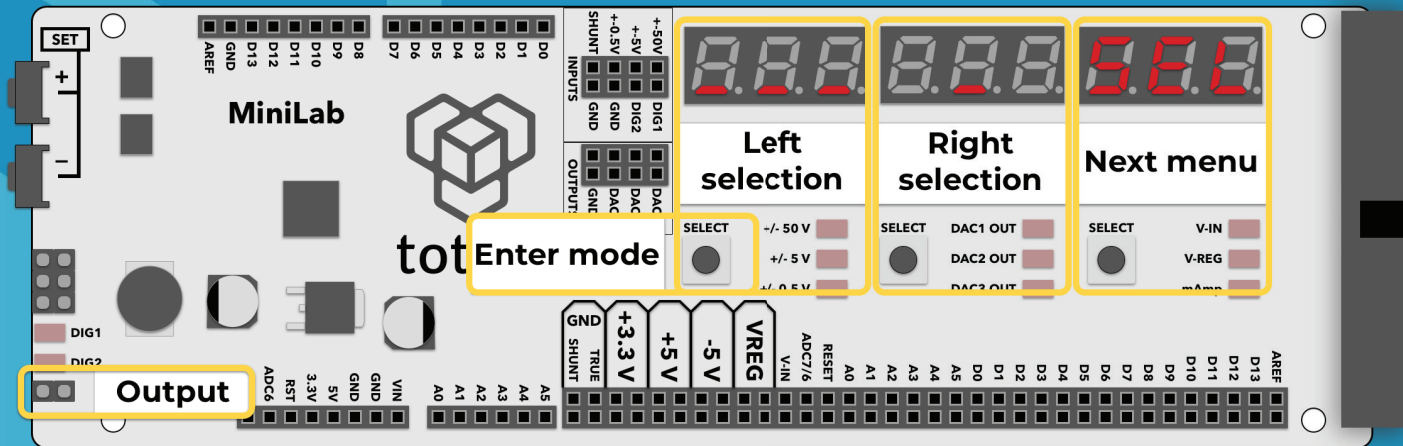

11. Power scheme

Mini Lab is designed to be powered from the included 12V 1A power adapter, but a USB connection can be used for a reduced functionality mode.

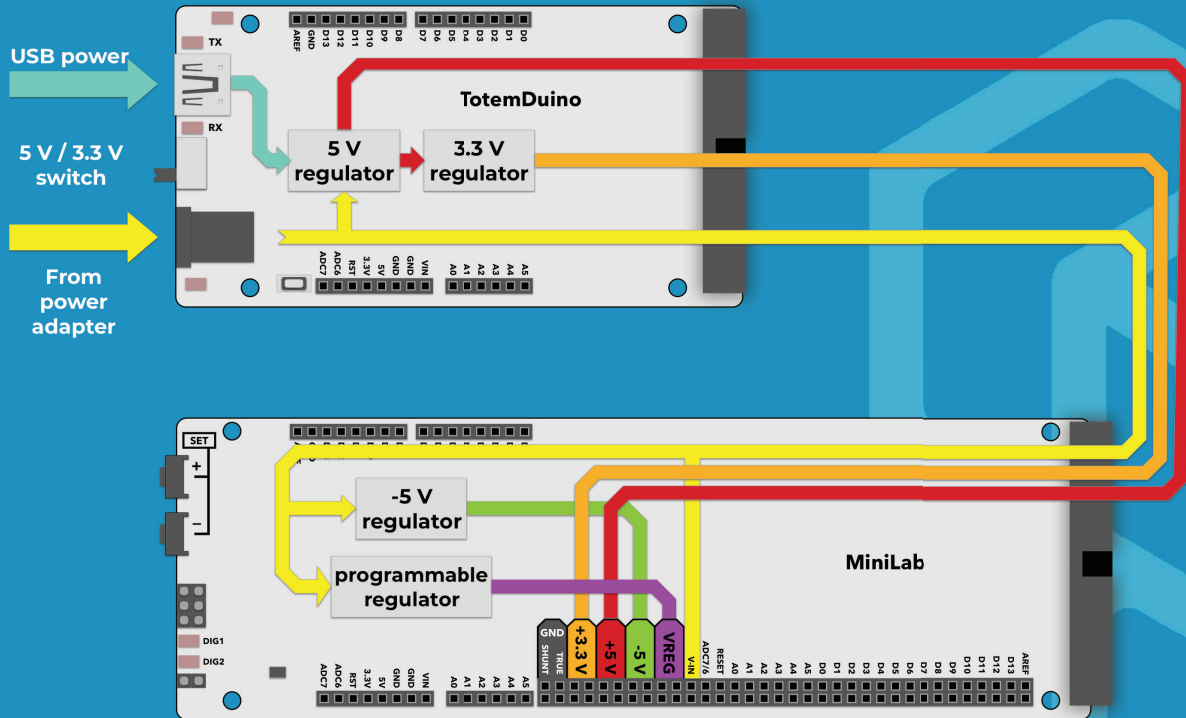

12. Going further

Mini Lab can be expanded with a number of easily mountable add-ons, Side Panels, giving you access to a variety of ready to use electronic modules.

Visit totemmaker.net for a detailed user manual with usage examples, code samples and example sketches.

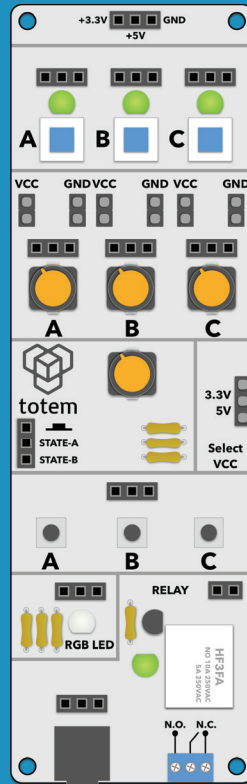

Input/Output Side Panel

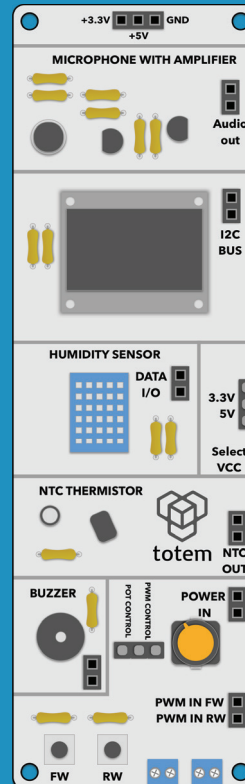

Sensor Side Panel



Audio Side Panel



PRECAUTIONS: ELECTRONICALLY OPERATED PRODUCT

Safety warnings:

- Never connect the Mini Lab to a different power supply, use only the included power supply.
- Place the power cord so you cannot stumble on it or step on it, or otherwise expose it to any potential damage. Also, make sure that the power cord is not mechanically or otherwise damaged. If so, stop using the damaged power cord immediately, and replace it.
- Do not expose this product to water or moisture, and do not place it on a conductive surface whilst in operation.
- Do not expose this product to heat from any source; it is designed for reliable operation at normal room temperatures.
- The device is for indoor use only.
- Do not expose board to high intensity light sources (e.g. xenon flash or laser)
- Operate this product in a well-ventilated environment, and do not cover it during use.
- Place this product on a stable, flat, non-conductive surface while in use, and do not let it contact conductive items.
- Take care while handling this product to avoid mechanical or electrical damage to the printed circuit board and connectors.
- Avoid handling this product while it is powered. Only handle by the edges to minimize the risk of electrostatic discharge damage.

Electronics protection:

WARNING: Make sure to protect the electronics against electrostatic discharge (ESD). Always unpack the electronics right before you need them!

Here are some tips to prevent damage to the electronics:

- Keep the electronics inside the ESD bag right until you are asked to install them.
- Always touch the sides of the board while manipulating with it. Avoid touching the chips, capacitors and other parts of the electronics.
- Before you touch the electronics use any conductive (steel) structure nearby to discharge yourself.
- Be extra cautious in the rooms with carpets, which are a source of electrostatic energy.
- Clothes from wool and certain synthetic fabrics can easily gather static electricity. It is safer to wear cotton clothing.



This product should not be disposed with other household wastes. To prevent possible harm to the environment or human health from uncontrolled waste disposal, recycle it responsibly to promote the sustainable reuse of material resources. To return your used device, please use the return and collection systems or contact the retailer where the product was purchased. They can take this product for environmentally safe recycling.

Disclaimer

Failure to read the handbook may lead to personal injury, inferior results, or damage to the Totem Mini Lab. We cannot control the conditions in which you assemble the Totem Mini Lab. For this, and other reasons, we do not assume responsibility, and expressly disclaim liability for loss, injuries, damage, or expense arising out of, or in any way connected with, the assembly, handling, storage, use or disposal of the product.

Due to the continuous product improvement, the pictures on this manual may differ slightly from the actual product. Please adhere to actual product instead.

Discover the joy of making

UPGRADE TO NO LIMIT

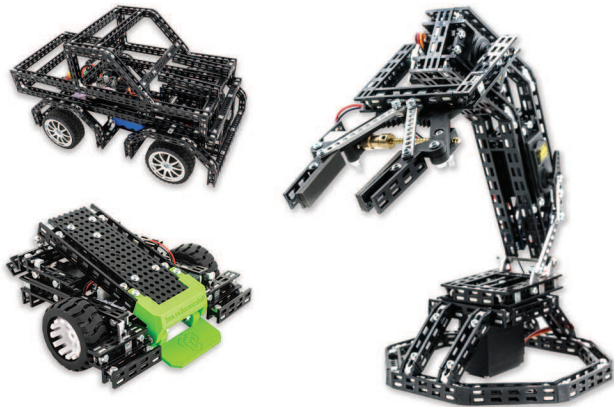

Caution: this is not a toy and is intended for use by or under the supervision of adults.



FOLLOW US:



For customer support please contact:
support@totemaker.net

www.totemaker.net