

ATTEN

ST-1101 ST-1101D
ST-1202 ST-1202D

FUME EXTRACTOR

IMPORTANT SAFETY INFORMATION

Read all instructions before using the appliance and retain for future reference.

- This product should never be used/placed at high temperature, high humidity or in a flammable, explosive and strong electromagnetic environment.
- When not in use for extended periods, switch the appliance off and disconnect from the mains.
- This product is high voltage inside. All repairs should only be carried out by a qualified engineer. Improper repairs may place the user at risk of harm.
- To avoid any damage, when the impeller rotates at high speed, do not touch it with hands or objects.

Caution

- The smog suction' s effect is affected by the distance between the smog suction hood and the point of smog generated directly. Tests proved that the best distance is maintained at 10-15cm.
- If air flow speed surrounding the smog suction hood is fast, the smog suction effect will be worse. Need to reduce the air flow.
- The longer length of smog suction pipes, the weaker effect of smog suction. The more smog suction pipe bends, the worse effect of smog suction. Recommendation: Minimize the pipe bends as much as possible.

Filter Element Replacement

This product relies on a variety of filter cartridge parts to achieve filtering the smog, smell, toxic substances. Therefore, the filter element parts as consumptive material, with the amount of saturation, should be replaced on a regular basis.

Recommended replacement cycle:

Primary filter: 10-15 days

Medium efficiency filter: 3-6 months

Main filter: 6-9 months

The replacement period depends on the actual situation, i.e. different amounts of pollution generated in different places. Please pay attention to the use and maintenance of the machine specified above, and replace the filter element parts regularly;

Otherwise, it will lead to reduced suction, equipment damage, early scrapping of filters and environmental pollution accidents and personal injury, which are not within the scope of our company's responsibility.

ATTEN

ST-1101 ST-1101D
ST-1202 ST-1202D

FUME EXTRACTOR

Product overview

- 1.The appearance is simple and generous.The integrated design of the host adopts metal frame structure, which is durable.
- 2.Both sides are equipped with concave high-quality plastic handles, which is stable, reliable and easy to move.
- 3.Brushless DC motor and built-in controller are adopted to ensure performance and quality.
- 4.Limit governor is installed, the air volume and flow can be adjusted as needed.
- 5.The wind wheel is made of special alloy to effectively prevent corrosion. The unique dynamic balance correction technology makes the wind wheel run more stably and reliably. Large air volume, large suction, higher filtration rate.
- 6.Adopted triple filtration design. Filter layer by layer to ensure that harmful smoke and dust are filtered more thoroughly. The purification rate can reach 99.97%.
- 7.The primary, medium and high efficiency filter can be replaced separately, with longer service life and lower replacement cost.
- 8.Flexible tube can change direction and position as needed (the length can be customized). No need to lay additional pipes. Installation simple and convenient use.

Operating principle

This purifier uses physical type active purification filter. Pollutants are sucked in by vortex centrifugal fan, after being purified by multi-layer filtering device, the clean air is directly discharged into the room. (It can also be connected to smoke exhaust pipe to discharge the smoke and dust outdoors.)

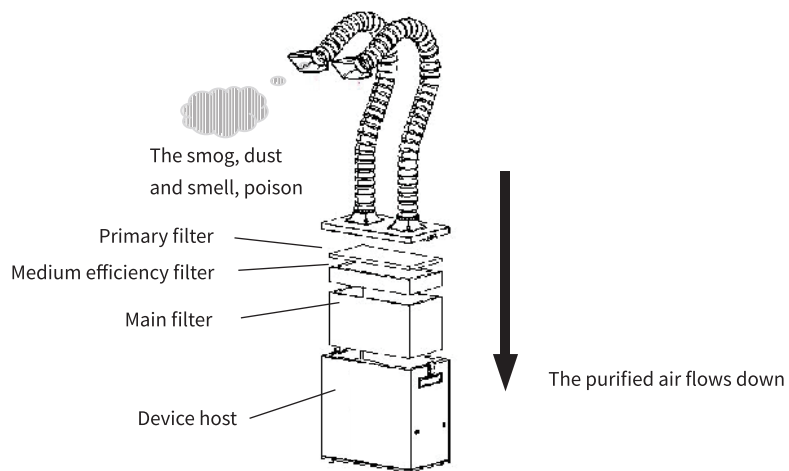

Knob operation description(ST-1101/ST-1202)

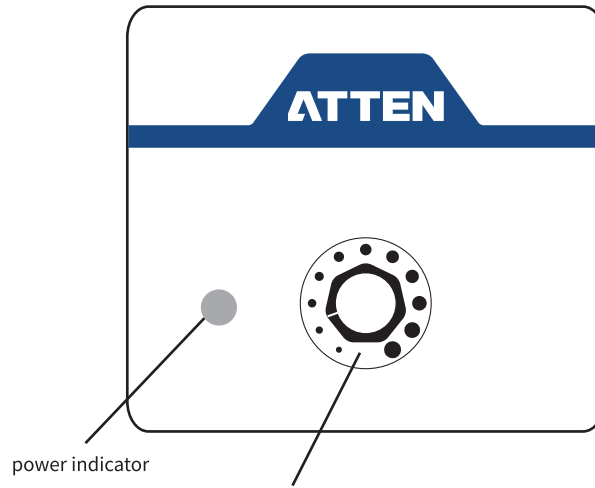

Turn the knob to adjust the air volume

LCD display description(ST-1101D/ST-1202D)

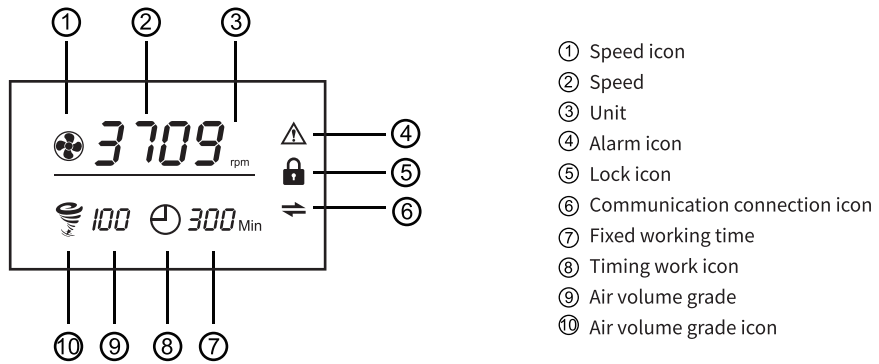

Panel buttons

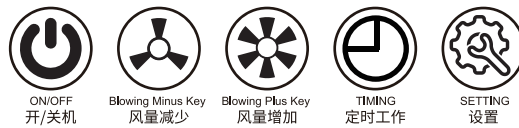

Product assembly

1. Open the packing box, take out the smoking pipe, primary filter and the host of the smoke purifier.
2. The package bag of smoking pipe contains flexi tube, tube joint and silica gel cover.

Connect the above components as shown below:

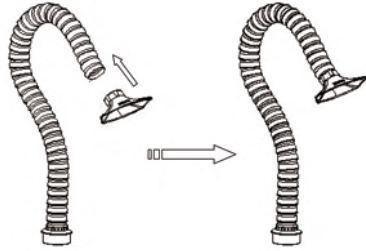

Silica gel cover installation instruction

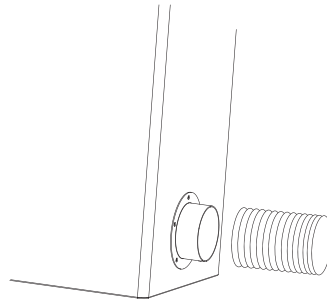

PVC duct pipe installation instruction

3. Take out the smoke purifier and place it on a flat ground or table. Machines with casters need to lock the caster to avoid vibration or movement.
4. Insert the flexi tube into the flange hole of the upper cover of the machine, adjust the collector hood so it is approximately 20cm from the source of the fume or smoke.

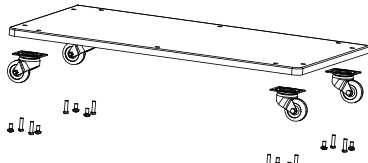

Roller Installation Instruction

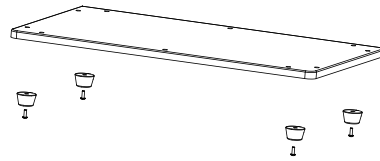

Machine Foot Pads Installation Instruction

Operating instructions (ST-1101/ST-1202)

1. Connect the power supply and turn it on.
2. Turn the knob to start the machine (the indicator light is on) and adjust the air volume.



Operating instructions (ST-1101D/ST-1202D)

1. Connect the power supply and turn it on







Working interface

2. Air volume grade adjustment

Click  and  to adjust the air volume (air volume grade range 1-100). Short press one time to adjust one unit air volume grade; long press to achieve fast adjustment. The air volume data displayed on the screen will also change accordingly.

3. Timing work setting

Short press  to turn on/off timing function.

In the working state, short press the  key to enter the fixed working time setting. When the display icon flashes, press  and  key to adjust the fixed working time. (After 4s no-operation, it will automatically exit and save the data)







Close at regular working hours



Set regular working time

4. Communication connection address code setting

In the working state, short press  to enter address code setting. When  flashes, short press  and  to adjust address code. (After 4s no-operation, it will automatically exit and save the data)

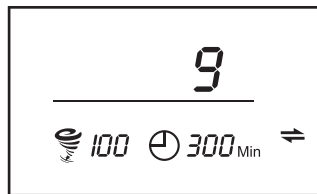



Communication connection address code setting

5. Alarm function

1. Filter failure alarm. When the filter is saturated, the equipment will make an alarm sound (lasts for 11S), meanwhile, the screen display  flashes to prompt for replacement. At this time, please timely check and replace the filter cotton or check other equipment problems.

2. Fan fault alarm. When the machine detects a fan component failure, the screen display  flashes, and relevant fault codes show up; the equipment will make an alarm sound and stop working within a certain period of time. At this time, please timely check the fan error reason and repair it. (display F-E error code)

6. Panel Lock

Long press  key on front panel for 5 seconds to lock or unlock the panel key. Short press  key on the remote control to lock or unlock the panel key. After the panel is locked, the panel keys and remote control keys cannot be operated (except the  keys).

7. Communication function

The host is equipped with RS485 interface, which can be connected with the computer, soldering station/hot air station for synchronous operation command.

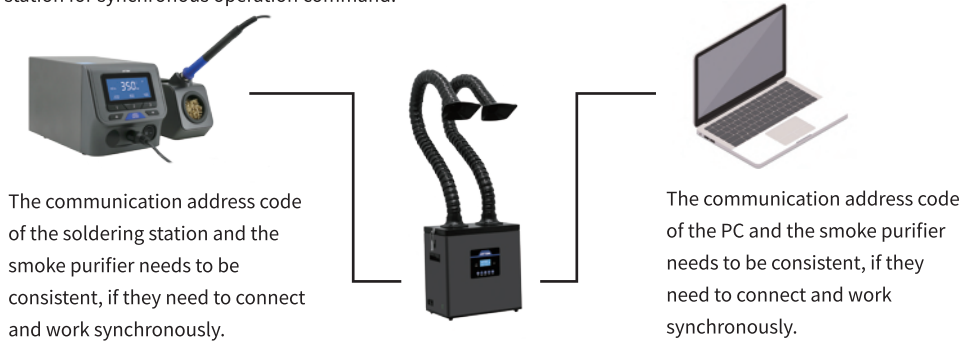

Remote control layout and function

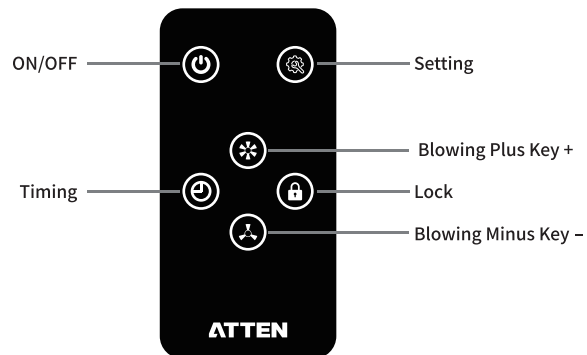

Replacement and maintenance of filter

1. Due to the physical filtration mode adopted by this smoke purification equipment, the filtration device (primary effect filter, medium effect filter and main filter) has rated saturation. When the adsorbed dust, particles and other pollutants reach a certain degree, the filtering device will be blocked and lose the purification effect. At this time, it is necessary to replace a new filtering device to meet the filtering demand.

2. Judgments to replace the filter element: the various filters will require periodic replacement depending on the type of use the device is put to.

Primary filter - check and replace every 10-15 days usage.

Medium efficiency filter - check and replace every 3-6 months usage.

Main filter - replace every 6-9 months usage.

This data is only for reference, the filter element specific periodic replacement is mainly based on the use environment of each place.

3. In the following cases, it is deemed necessary to replace the filter.

A: Replacement characteristics of primary and medium efficiency filter. The suction becomes reduced; The filter turns yellow or black, and many particles can be seen on the surface; It can also be replaced regularly according to the filter cycle.

B: Replacement characteristics of main filter. When the equipment gives an alarm or the suction is seriously reduced or the odor at the exhaust outlet is serious. Check and replace the primary and medium efficiency filter first, if the suction is still weak and the odor is still serious, the main filter needs to be replaced.

4. Replacement steps of filter:

A. Replacement steps of filter:

B. Unlatch the two catches on both sides and remove the upper cover.

C. Replacement of primary filter element: remove the old cotton filter and replace with a new cotton element laid flat onto the medium filter element.

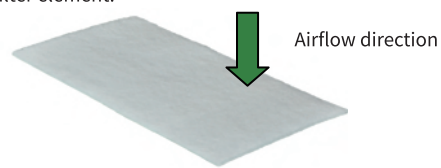

D. Replacement of medium efficiency filter element: hold the tab on both ends of the medium-effect filter element and gently pull it out of the recess in the high efficiency filter. Replace the new element with the tabs uppermost and press into the recess in the high efficiency filter.

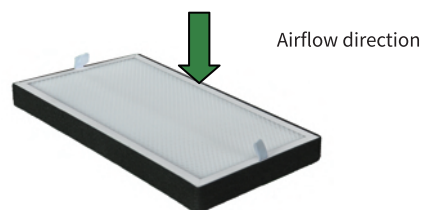

E. Replacement of high efficiency filter element: After removing the primary filter and medium efficiency filter, extract the main filter by holding it at both ends and gently pulling upwards. Replace with a new main filter inserted into the device, then insert the medium effect filter and the primary filter in turn.

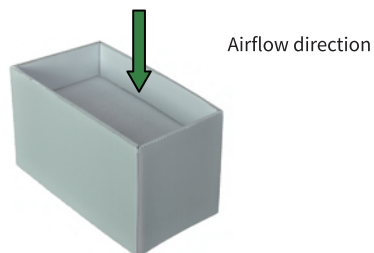

F. Finally, put back the upper cover, latch the two catches on both sides, re-attach the flexi tubes to finish the replacement process.

Product warranty card

This product is guaranteed for two years from the date of purchase.
If any quality problem is found within the guarantee period, we will respond for the maintenance free of charge on presentation of this card and the receipt.

Note: This warranty card must be attached when this product is returned to the factory for maintenance, otherwise free maintenance will not be accepted.

Thank you for your cooperation!

Product Certification

Product Model: _____ Product NO.: _____

Inspector: _____ EX-Factory date: _____

Salesperson: _____ Sold Date: _____

This product test result is qualified and met the technical standard.

SHENZHEN ATTEN TECHNOLOGY CO.,LTD.

- Soldering Iron
- Soldering Station
- Hot Air Rework Station
- Multi-function Rework System
- Switching DC Power Supply
- Regulated DC Power Supply
- Solder smoke purify machine
- Programmable Power Supply

SHENZHEN ATTEN TECHNOLOGY CO.,LTD.

**Add: 8 Floor, Building 2, Senyang High-tech Park, No. 7 Road,
Guangming District, Shenzhen 518132, China**

Tel: +86-755-2697 6181

Web: www.atten.com

Email: sales@atten.com.cn

MADE IN CHINA